

# ferramenta

**VITI**

**TASSELLI**

**MENSOLE**

**GIUNZIONI**

**CERNIERE**

**CATENACCI**

**LUCCHETTI**

**MORSETTI**

**CASSEFORTI**

**CASSETTE POSTA**

**TELECOMANDI**

**CHIAVI**

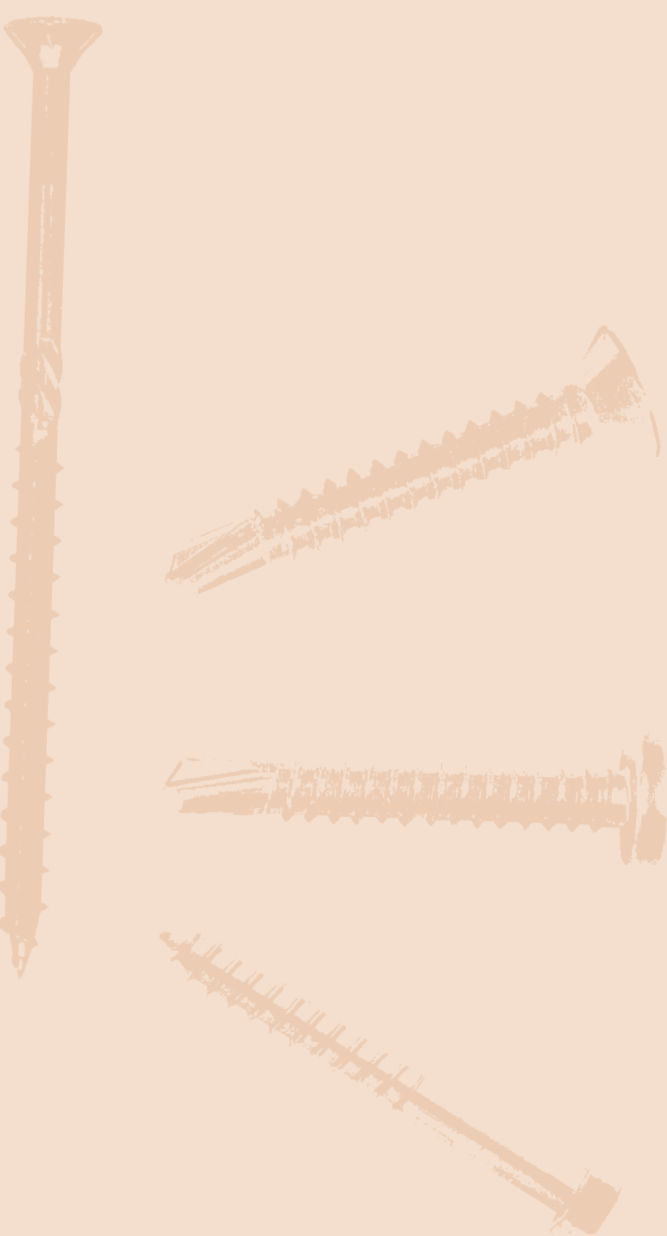
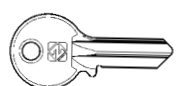

**OCCHIOLO CON VITE A LEGNO  
ACCIAIO ZINCATO 100ZN**

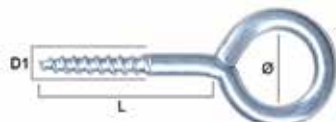

Cod.	Art	Ø mm	L mm	Conf.	Prezzo conf.
800116025	16x25	4	10	200	16,75 €
800116030	16x30	4	12	200	16,75 €
800116040	16x40	6	16	200	17,00 €
800117030	17x30	5	12	200	17,50 €
800117040	17x40	6	18	200	17,85 €
800117050	17x50	6	20	200	19,65 €
800118040	18x40	6	16	200	20,15 €
800118050	18x50	8	20	200	21,95 €
800118060	18x60	8	24	200	22,55 €
800119050	19x50	7	18	200	23,90 €
800119060	19x60	9	25	200	24,85 €
800119070	19x70	9	30	200	27,65 €
800120050	20x50	8	18	200	24,85 €
800120060	20x60	8	20	200	27,90 €
800120070	20x70	10	25	200	30,80 €
800120080	20x80	12	30	200	32,50 €
800120100	20x100	14	45	200	36,80 €
800121070	21x70	10	25	200	38,70 €
800121080	21x80	12	30	200	40,80 €
800121100	21x100	14	40	200	48,10 €
800122080	22x80	12	30	200	55,70 €
800122090	22x90	12	35	200	57,40 €
800122100	22x100	14	40	200	62,80 €
800122120	22x120	16	50	200	72,80 €
800123100	23x100	14	40	100	38,40 €
800123120	23x120	16	50	100	44,80 €
800123140	23x140	18	60	100	50,00 €

**OCCHIOLO CON VITE A LEGNO OTTONE 100E**



Cod.	Art	Ø mm	L mm	Conf.	Prezzo conf.
800214030	14x30	7	12	200	35,90 €
800217035	17x35	5	15	200	44,30 €
800218040	18x40	6	16	200	63,20 €
800219050	19x50	7	18	200	84,30 €
800220060	20x60	8	20	200	125,50 €
800221070	21x70	10	25	200	188,00 €

**GANCIO CON VITE A LEGNO OTTONE 103E**

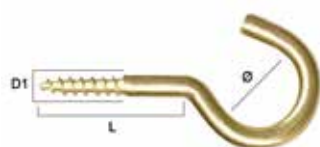

Cod.	Art	Ø mm	L mm	Conf.	Prezzo conf.
800619070	19x70	14	25	200	112,50 €
800620070	20x70	14	25	200	163,00 €

**GANCIO CON VITE A LEGNO  
ACCIAIO ZINCATO 103ZN**

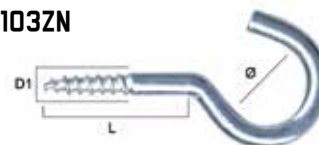

Cod.	Art	Ø mm	L mm	Conf.	Prezzo conf.
800314030	14x30	6	10	200	17,00 €
800316030	16x30	6	10	200	17,50 €
800316040	16x40	8	16	200	17,60 €
800317035	17x35	8	14	200	19,65 €
800317040	17x40	8	16	200	19,65 €
800317050	17x50	10	20	200	21,70 €
800318040	18x40	8	12	200	20,85 €
800318050	18x50	10	16	200	22,55 €
800318060	18x60	12	20	200	23,55 €
800319050	19x50	10	18	200	23,90 €
800319060	19x60	12	20	200	26,80 €
800319070	19x70	14	25	200	27,65 €
800319080	19x80	16	30	200	29,70 €
800320060	20x60	12	20	200	27,05 €
800320070	20x70	14	25	200	30,10 €
800320080	20x80	16	30	200	32,40 €
800321070	21x70	14	25	200	38,80 €
800321080	21x80	16	30	200	42,70 €
800321100	21x100	20	40	200	49,10 €
800322080	22x80	16	25	200	53,50 €
800322100	22x100	20	35	200	62,80 €
800322120	22x120	25	50	200	73,90 €

**RAMPINO CON VITE A LEGNO  
ACCIAIO ZINCATO 104.5ZN**



Cod.	Art	H mm	L mm	Conf.	Prezzo conf.
800414025	14x25	10	18	200	18,70 €
800414030	14x30	10	22	200	18,80 €
800416030	16x30	11,5	20	200	19,65 €
800416035	16x35	11,5	25	200	19,80 €
800416040	16x40	11,5	30	200	20,75 €
800417035	17x35	12,5	25	200	20,85 €
800417040	17x40	12,5	30	200	21,85 €
800417050	17x50	13,5	40	200	23,40 €
800418040	18x40	14	30	200	22,55 €
800418050	18x50	15	40	200	23,55 €
800418060	18x60	16	45	200	25,50 €
800419040	19x40	15,5	30	200	27,65 €
800419050	19x50	15,5	40	200	29,70 €
800419060	19x60	16,5	45	200	31,30 €
800420050	20x50	18	35	200	29,85 €
800420060	20x60	19	45	200	32,40 €
800420070	20x70	20	50	200	34,70 €
800420080	20x80	20	60	200	36,80 €
800421050	21x50	20,5	35	200	40,80 €
800421060	21x60	20,5	45	200	42,70 €
800421070	21x70	23,5	60	200	44,80 €
800421080	21x80	23,5	60	200	48,10 €
800421100	21x100	24,5	80	200	57,40 €
800422060	22x60	24	40	200	55,70 €
800422070	22x70	25	50	200	60,70 €
800422080	22x80	25	60	200	65,00 €
800422100	22x100	27	100	200	73,50 €
800423080	23x80	26	60	100	37,90 €
800423100	23x100	29	80	100	44,10 €
800423120	23x120	29	100	100	49,40 €

## RAMPINO CON VITE OTTONE 104.5E

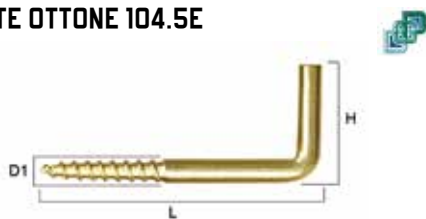

Cod.	Art	H mm	L mm	Conf.	Prezzo conf.
800514030	14x30	10	22	200	26,55 €
800517040	17x40	12,5	30	200	38,10 €
800518040	18x40	14	30	200	41,10 €
800520070	20x70	20	50	200	74,80 €

## GIRELLA VITE ACCIAIO ZINCATO 125ZN



Cod.	Art	H mm	L mm	Conf.	Prezzo conf.
800719030	19x30	20	30	200	93,10 €
800720030	20x30	21	30	200	99,70 €
800720035	20x35	21	35	200	108,00 €
800721035	21x35	26	35	200	110,00 €
800721040	21x40	26	40	200	117,50 €
800722045	22x45	27	45	200	175,00 €

## RAMPINO PER FINESTRA ACCIAIO ZINCATO 105ZN



Cod.	Art	L mm	Conf.	Prezzo conf.
800819060	19x60	60	100	81,60 €
800819080	19x80	80	100	87,00 €
800820100	20x100	100	100	104,50 €
800820120	20x120	120	100	108,00 €
800821120	21x120	120	100	122,00 €
800821140	21x140	140	100	127,00 €
800822140	22x140	140	50	76,20 €
800822160	22x160	160	50	82,10 €
800822180	22x180	180	50	99,90 €

## VITE TPS TRUCIOLARE VBU-TPS FILETTO TOTALE BRONZATA

Impronta Pozidrive. Ogni confezione contiene un inserto.



Cod.	Ø mm	L mm	Descrizione	Conf.	Prezzo conf.
FRVBUBRB25010	2,5	10	bronzata	500	6,30 €
FRVBUBRB25012	2,5	12	bronzata	500	6,74 €
FRVBUBRB25016	2,5	16	bronzata	500	7,35 €
FRVBUBRB25020	2,5	20	bronzata	500	8,36 €
FRVBUBRB25025	2,5	25	bronzata	500	9,73 €
FRVBUBRB30012	3	12	bronzata	500	5,75 €
FRVBUBRB30016	3	16	bronzata	500	6,35 €
FRVBUBRB30018	3	18	bronzata	500	6,64 €
FRVBUBRB30020	3	20	bronzata	500	6,99 €
FRVBUBRB30025	3	25	bronzata	500	8,02 €
FRVBUBRB30030	3	30	bronzata	500	9,50 €
FRVBUBRB30035	3	35	bronzata	500	11,05 €
FRVBUBRB30040	3	40	bronzata	500	14,70 €
FRVBUBRB30045	3	45	bronzata	500	17,90 €
FRVBUBRB35012	3,5	12	bronzata	500	7,09 €
FRVBUBRB35016	3,5	16	bronzata	500	7,68 €
FRVBUBRB35018	3,5	18	bronzata	500	8,36 €
FRVBUBRB35020	3,5	20	bronzata	500	8,67 €
FRVBUBRB35025	3,5	25	bronzata	500	9,65 €
FRVBUBRB35030	3,5	30	bronzata	500	11,25 €
FRVBUBRB35035	3,5	35	bronzata	500	12,80 €
FRVBUBRB35040	3,5	40	bronzata	500	13,80 €
FRVBUBRB35045	3,5	45	bronzata	500	19,45 €
FRVBUBRB35050	3,5	50	bronzata	500	23,50 €
FRVBUBRB40016	4	16	bronzata	500	9,05 €
FRVBUBRB40018	4	18	bronzata	500	9,89 €
FRVBUBRB40020	4	20	bronzata	500	10,20 €
FRVBUBRB40025	4	25	bronzata	500	11,55 €
FRVBUBRB40030	4	30	bronzata	500	12,85 €
FRVBUBRB40035	4	35	bronzata	500	15,20 €
FRVBUBRB40040	4	40	bronzata	500	16,55 €
FRVBUBRB40045	4	45	bronzata	200	7,94 €
FRVBUBRB40050	4	50	bronzata	200	9,30 €
FRVBUBRB40060	4	60	bronzata	200	12,35 €
FRVBUBRB40070	4	70	bronzata	200	20,25 €
FRVBUBRB45020	4,5	20	bronzata	500	14,00 €
FRVBUBRB45025	4,5	25	bronzata	500	15,20 €
FRVBUBRB45030	4,5	30	bronzata	500	16,25 €
FRVBUBRB45035	4,5	35	bronzata	500	19,25 €
FRVBUBRB45040	4,5	40	bronzata	500	20,90 €
FRVBUBRB45045	4,5	45	bronzata	200	9,68 €
FRVBUBRB45050	4,5	50	bronzata	200	10,75 €
FRVBUBRB45060	4,5	60	bronzata	200	13,65 €
FRVBUBRB45070	4,5	70	bronzata	200	17,80 €
FRVBUBRB50020	5	20	bronzata	500	16,30 €
FRVBUBRB50025	5	25	bronzata	500	18,40 €
FRVBUBRB50030	5	30	bronzata	500	20,50 €
FRVBUBRB50035	5	35	bronzata	200	9,07 €
FRVBUBRB50040	5	40	bronzata	200	10,05 €
FRVBUBRB50045	5	45	bronzata	200	11,90 €
FRVBUBRB50050	5	50	bronzata	200	12,30 €
FRVBUBRB50060	5	60	bronzata	200	14,60 €
FRVBUBRB50070	5	70	bronzata	200	18,95 €
FRVBUBRB60030	6	30	bronzata	200	14,05 €
FRVBUBRB60040	6	40	bronzata	200	15,70 €
FRVBUBRB60050	6	50	bronzata	200	18,25 €
FRVBUBRB60060	6	60	bronzata	200	22,40 €
FRVBUBRB60070	6	70	bronzata	200	25,95 €

## VITE TRUCIOLARE VBU-TPS FILETTO PARZIALE BRONZATO

Impronta Pozidrive.  
Ogni confezione contiene  
un inserto.



Cod.	Ø mm	L mm	Descrizione	Conf.	Prezzo conf.
FRVBUPBR35030	3,5	30	bronzata	1000	21,65 €
FRVBUPBR35035	3,5	35	bronzata	500	11,90 €
FRVBUPBR35040	3,5	40	bronzata	500	13,60 €
FRVBUPBR35045	3,5	45	bronzata	500	20,00 €
FRVBUPBR35050	3,5	50	bronzata	500	24,25 €
FRVBUPBR40030	4	30	bronzata	1000	26,20 €
FRVBUPBR40035	4	35	bronzata	500	14,85 €
FRVBUPBR40040	4	40	bronzata	500	17,90 €
FRVBUPBR40045	4	45	bronzata	500	20,20 €
FRVBUPBR40050	4	50	bronzata	500	23,25 €
FRVBUPBR40060	4	60	bronzata	200	12,35 €
FRVBUPBR40070	4	70	bronzata	200	18,55 €
FRVBUPBR45035	4,5	35	bronzata	500	18,85 €
FRVBUPBR45040	4,5	40	bronzata	500	20,45 €
FRVBUPBR45045	4,5	45	bronzata	500	23,75 €
FRVBUPBR45050	4,5	50	bronzata	500	27,90 €
FRVBUPBR45060	4,5	60	bronzata	200	13,45 €
FRVBUPBR45070	4,5	70	bronzata	200	18,25 €
FRVBUPBR45080	4,5	80	bronzata	200	22,45 €
FRVBUPBR50040	5	40	bronzata	500	23,80 €
FRVBUPBR50045	5	45	bronzata	500	27,90 €
FRVBUPBR50050	5	50	bronzata	500	30,40 €
FRVBUPBR50060	5	60	bronzata	200	15,15 €
FRVBUPBR50070	5	70	bronzata	200	17,85 €
FRVBUPBR50080	5	80	bronzata	200	21,25 €
FRVBUPBR50090	5	90	bronzata	200	29,30 €
FRVBUPBR50100	5	100	bronzata	100	15,00 €
FRVBUPBR50120	5	120	bronzata	100	27,00 €
FRVBUPBR60050	6	50	bronzata	200	17,85 €
FRVBUPBR60060	6	60	bronzata	200	20,60 €
FRVBUPBR60070	6	70	bronzata	200	24,20 €
FRVBUPBR60080	6	80	bronzata	200	29,40 €
FRVBUPBR60090	6	90	bronzata	200	33,70 €
FRVBUPBR60100	6	100	bronzata	100	20,00 €
FRVBUPBR60110	6	110	bronzata	100	25,35 €
FRVBUPBR60120	6	120	bronzata	100	26,95 €
FRVBUPBR60130	6	130	bronzata	100	31,10 €
FRVBUPBR60140	6	140	bronzata	100	35,60 €
FRVBUPBR60150	6	150	bronzata	100	47,20 €
FRVBUPBR60160	6	160	bronzata	100	50,60 €
FRVBUPBR60180	6	180	bronzata	100	69,80 €
FRVBUPBR60200	6	200	bronzata	100	88,20 €

## VITE TRUCIOLARE VBU-TPS FILETTO PARZIALE ZINCATA

Impronta Pozidrive.  
Ogni confezione  
contiene un inserto.



Cod.	Ø mm	L mm	Descrizione	Conf.	Prezzo conf.
021476	4,5	80	zincata	200	21,00 €
014746	5	80	zincata	200	21,20 €
016000	5	100	zincata	100	15,00 €
040461	6	70	zincata	200	21,35 €
000987	6	80	zincata	200	26,15 €
002614	6	100	zincata	100	18,50 €
020017	6	120	zincata	100	25,45 €

## VITE TRUCIOLARE VBU-TPS FILETTO TOTALE ZINCATA

Impronta Pozidrive.  
Ogni confezione  
contiene un inserto.



Cod.	Ø mm	L mm	Descrizione	Conf.	Prezzo conf.
FRVBUIZB30012	3	12	zincata	500	5,59 €
FRVBUIZB30016	3	16	zincata	500	5,82 €
FRVBUIZB30018	3	18	zincata	500	6,08 €
FRVBUIZB30020	3	20	zincata	500	6,26 €
FRVBUIZB30025	3	25	zincata	500	7,47 €
FRVBUIZB30030	3	30	zincata	500	8,90 €
FRVBUIZB30035	3	35	zincata	500	10,25 €
FRVBUIZB30040	3	40	zincata	500	11,80 €
FRVBUIZB30045	3	45	zincata	500	14,85 €
FRVBUIZB35012	3,5	12	zincata	500	6,46 €
FRVBUIZB35016	3,5	16	zincata	500	6,57 €
FRVBUIZB35018	3,5	18	zincata	500	7,09 €
FRVBUIZB35020	3,5	20	zincata	500	7,53 €
FRVBUIZB35025	3,5	25	zincata	500	8,43 €
FRVBUIZB35030	3,5	30	zincata	500	9,64 €
FRVBUIZB35035	3,5	35	zincata	500	10,75 €
FRVBUIZB35040	3,5	40	zincata	500	12,35 €
FRVBUIZB35045	3,5	45	zincata	500	18,00 €
FRVBUIZB35050	3,5	50	zincata	500	20,70 €
FRVBUIZB40016	4	16	zincata	500	8,38 €
FRVBUIZB40018	4	18	zincata	500	8,84 €
FRVBUIZB40020	4	20	zincata	500	8,92 €
FRVBUIZB40025	4	25	zincata	500	10,35 €
FRVBUIZB40030	4	30	zincata	500	11,65 €
FRVBUIZB40035	4	35	zincata	500	13,05 €
FRVBUIZB40040	4	40	zincata	500	14,40 €
FRVBUIZB40045	4	45	zincata	200	7,14 €
FRVBUIZB40050	4	50	zincata	200	8,40 €
FRVBUIZB40060	4	60	zincata	200	11,15 €
FRVBUIZB45020	4,5	20	zincata	500	11,45 €
FRVBUIZB45025	4,5	25	zincata	500	12,90 €
FRVBUIZB45030	4,5	30	zincata	500	14,30 €
FRVBUIZB45035	4,5	35	zincata	500	16,25 €
FRVBUIZB45040	4,5	40	zincata	500	17,70 €
FRVBUIZB45045	4,5	45	zincata	200	8,62 €
FRVBUIZB45050	4,5	50	zincata	200	9,71 €
FRVBUIZB45060	4,5	60	zincata	200	11,85 €
FRVBUIZB45070	4,5	70	zincata	200	17,95 €
FRVBUIZB50025	5	25	zincata	500	15,40 €
FRVBUIZB50030	5	30	zincata	500	17,60 €
FRVBUIZB50035	5	35	zincata	200	8,22 €
FRVBUIZB50040	5	40	zincata	200	8,62 €
FRVBUIZB50045	5	45	zincata	200	9,74 €
FRVBUIZB50050	5	50	zincata	200	10,75 €
FRVBUIZB50060	5	60	zincata	200	13,60 €
FRVBUIZB50070	5	70	zincata	200	18,20 €
FRVBUIZB60040	6	40	zincata	200	14,05 €
FRVBUIZB60050	6	50	zincata	200	16,50 €
FRVBUIZB60060	6	60	zincata	200	19,95 €
FRVBUIZB60070	6	70	zincata	200	24,40 €

## VITE VBU PRO TORX TPS ZINCATA GIALLA

Impronta Torx.  
Ogni confezione  
contiene  
un inserto.



Cod.	Ø mm	L mm	Descrizione	Conf.	Prezzo conf.
FRVBUPZG30020	3	20	zincata	500	9,22 €
FRVBUPZG30025	3	25	zincata	500	10,25 €
FRVBUPZG30030	3	30	zincata	500	12,10 €
FRVBUPZG30035	3	35	zincata	500	12,10 €
FRVBUPZG30040	3	40	zincata	500	14,55 €
FRVBUPZG35020	3,5	20	zincata	500	10,45 €
FRVBUPZG35025	3,5	25	zincata	500	11,40 €
FRVBUPZG35030	3,5	30	zincata	500	12,30 €
FRVBUPZG35035	3,5	35	zincata	500	15,25 €
FRVBUPZG35040	3,5	40	zincata	500	18,00 €
FRVBUPZG35045	3,5	45	zincata	500	20,35 €
FRVBUPZG35050	3,5	50	zincata	500	22,15 €
FRVBUPZG40025	4	25	zincata	500	13,50 €
FRVBUPZG40030	4	30	zincata	500	15,60 €
FRVBUPZG40035	4	35	zincata	500	17,75 €
FRVBUPZG40040	4	40	zincata	500	18,95 €
FRVBUPZG40045	4	45	zincata	200	9,21 €
FRVBUPZG40050	4	50	zincata	200	9,87 €
FRVBUPZG40060	4	60	zincata	200	15,85 €
FRVBUPZG40070	4	70	zincata	200	18,45 €
FRVBUPZG45025	4,5	25	zincata	500	18,20 €
FRVBUPZG45030	4,5	30	zincata	500	19,75 €
FRVBUPZG45035	4,5	35	zincata	500	22,55 €
FRVBUPZG45040	4,5	40	zincata	500	23,75 €
FRVBUPZG45045	4,5	45	zincata	200	10,95 €
FRVBUPZG45050	4,5	50	zincata	200	12,55 €
FRVBUPZG45060	4,5	60	zincata	200	16,85 €
FRVBUPZG50030	5	30	zincata	500	24,35 €
FRVBUPZG50035	5	35	zincata	500	11,75 €
FRVBUPZG50040	5	40	zincata	200	12,05 €
FRVBUPZG50045	5	45	zincata	200	14,05 €
FRVBUPZG50050	5	50	zincata	200	14,75 €
FRVBUPZG50060	5	60	zincata	200	17,90 €
FRVBUPZG50070	5	70	zincata	200	23,70 €
FRVBUPZG50080	5	80	zincata	200	30,90 €
FRVBUPZG50090	5	90	zincata	200	35,40 €
FRVBUPZG50100	5	100	zincata	100	19,50 €
FRVBUPZG50120	5	120	zincata	100	29,20 €
FRVBUPZG60040	6	40	zincata	200	14,75 €
FRVBUPZG60050	6	50	zincata	200	21,35 €
FRVBUPZG60060	6	60	zincata	200	24,90 €
FRVBUPZG60070	6	70	zincata	200	30,60 €

## RONDELLA PER WOOD PRO RG-WOOD



Cod.	mm	Pz	Conf.	Prezzo
031167	6	100	1	69,20 €
031168	8	100	1	84,00 €
031004	10	100	1	106,50 €

## VITE FM-WOOD PRO TPS PER LEGNO

Zincata gialla.  
Impronta Torx.  
Ogni confezione  
contiene un inserto.



Cod.	Ø mm	L mm	Descrizione	Conf.	Prezzo
FRFMWPD06080	6	80	zincata	100	11,70 €
FRFMWPD06100	6	100	zincata	100	15,20 €
FRFMWPD06120	6	120	zincata	100	19,60 €
FRFMWPD06140	6	140	zincata	100	25,15 €
FRFMWPD06160	6	160	zincata	100	34,50 €
FRFMWPD06180	6	180	zincata	100	34,50 €
FRFMWPD06200	6	200	zincata	100	55,50 €
FRFMWPD06220	6	220	zincata	100	84,90 €
FRFMWPD06240	6	240	zincata	100	95,50 €
FRFMWPD08080	8	80	zincata	100	24,55 €
FRFMWPD08090	8	90	zincata	100	26,90 €
FRFMWPD08100	8	100	zincata	100	28,85 €
FRFMWPD08120	8	120	zincata	50	19,50 €
FRFMWPD08140	8	140	zincata	50	23,50 €
FRFMWPD08160	8	160	zincata	50	26,35 €
FRFMWPD08180	8	180	zincata	50	33,70 €
FRFMWPD08200	8	200	zincata	50	40,00 €
FRFMWPD08220	8	220	zincata	50	46,60 €
FRFMWPD08240	8	240	zincata	50	60,20 €
FRFMWPD08260	8	260	zincata	50	69,00 €
FRFMWPD08280	8	280	zincata	50	81,90 €
FRFMWPD08300	8	300	zincata	50	85,60 €
FRFMWPD08320	8	320	zincata	50	95,10 €
FRFMWPD08340	8	340	zincata	50	101,00 €
FRFMWPD08360	8	360	zincata	50	106,50 €
FRFMWPD08380	8	380	zincata	50	112,00 €
FRFMWPD08400	8	400	zincata	50	122,50 €
FRFMWPD10080	10	80	zincata	50	19,65 €
FRFMWPD10100	10	100	zincata	50	23,55 €
FRFMWPD10120	10	120	zincata	50	25,25 €
FRFMWPD10140	10	140	zincata	50	32,50 €
FRFMWPD10160	10	160	zincata	50	37,50 €
FRFMWPD10180	10	180	zincata	50	48,70 €
FRFMWPD10200	10	200	zincata	50	66,70 €
FRFMWPD10220	10	220	zincata	50	75,20 €
FRFMWPD10240	10	240	zincata	50	83,10 €
FRFMWPD10260	10	260	zincata	50	110,00 €
FRFMWPD10280	10	280	zincata	50	115,00 €
FRFMWPD10300	10	300	zincata	50	126,00 €
FRFMWPD10320	10	320	zincata	50	140,00 €
FRFMWPD10340	10	340	zincata	50	148,00 €
FRFMWPD10360	10	360	zincata	50	163,00 €
FRFMWPD10380	10	380	zincata	50	181,50 €
FRFMWPD10400	10	400	zincata	50	184,00 €



**TUTTI I VANTAGGI DI FM-WOOD**  
Frese sottotesta,  
fresa fine filetto,  
filetto passo largo.



**OTTIMA CAPACITÀ DI PIEGATURA**  
Si adatta ed assorbe gli spostamenti assiali del legno.



**FRESA FINE FILETTO**  
Evita la formazione dell'effetto cono, creando la sede per il gambo.



**FRESA IN PUNTA + FILETTO MORDENTE**  
Avvitamento più semplice e possibilità di fissaggio vicino ai bordi.



**FRESE SOTTOTESTA**  
In avvitamento creano la sede per la testa, senza provocare tensioni.



**FRESA IN PUNTA + FILETTO MORDENTE**  
Avvitamento più semplice e possibilità di fissaggio vicino ai bordi.

## VITE TPS VBU FILETTO TOTALE PER LEGNO BRONZATA BLISTER

Impronta Pozidrive.  
Ogni confezione contiene un inserto.



Cod.	Ø mm	L mm	Pz	Conf.	Prezzo conf.
FRVBUPBR30160	3	16	50	30	1,38 €
FRVBUPBR30200	3	20	50	30	1,53 €
FRVBUPBR30250	3	25	50	30	1,74 €
FRVBUPBR30300	3	30	50	30	2,07 €
FRVBUPBR30350	3	35	50	30	2,41 €
FRVBUPBR35160	3,5	16	50	30	1,65 €
FRVBUPBR35180	3,5	18	50	30	1,78 €
FRVBUPBR35200	3,5	20	50	30	1,92 €
FRVBUPBR35250	3,5	25	50	30	2,08 €
FRVBUPBR35300	3,5	30	50	30	2,44 €
FRVBUPBR35350	3,5	35	50	30	2,75 €
FRVBUPBR35400	3,5	40	50	30	2,99 €
FRVBUPBR35500	3,5	50	50	30	4,98 €

FRVBUPBR40160	4	16	25	30	0,97 €
FRVBUPBR40200	4	20	25	30	1,12 €
FRVBUPBR40250	4	25	25	30	1,24 €
FRVBUPBR40300	4	30	25	30	1,39 €
FRVBUPBR40350	4	35	25	30	1,63 €
FRVBUPBR40400	4	40	25	30	1,77 €
FRVBUPBR40450	4	45	25	30	2,14 €
FRVBUPBR40500	4	50	25	30	2,50 €
FRVBUPBR40600	4	60	25	30	3,32 €

FRVBUPBR45250	4,5	25	25	30	1,65 €
FRVBUPBR45300	4,5	30	25	30	1,75 €
FRVBUPBR45350	4,5	35	25	30	2,08 €
FRVBUPBR45400	4,5	40	25	30	2,26 €
FRVBUPBR45450	4,5	45	25	30	2,66 €
FRVBUPBR45500	4,5	50	25	30	2,94 €
FRVBUPBR45600	4,5	60	25	30	3,71 €
FRVBUPBR45700	4,5	70	25	30	4,96 €

FRVBUPBR50300	5	30	25	30	2,22 €
FRVBUPBR50400	5	40	25	30	2,70 €
FRVBUPBR50500	5	50	25	30	3,30 €
FRVBUPBR50600	5	60	25	30	3,97 €
FRVBUPBR50700	5	70	25	30	4,99 €

FRVBUPBR60400	6	40	25	30	4,33 €
FRVBUPBR60500	6	50	25	30	4,92 €
FRVBUPBR60600	6	60	25	30	5,82 €

## VITE VBU TC TRUCIOLARE FILETTO TOTALE NERA

Impronta Pozidrive.



Cod.	Ø mm	L mm	Pz	Conf.	Prezzo conf.
FRVBUTC35120	3,5	20	500	1	11,05 €
FRVBUTC35125	3,5	25	500	1	12,95 €
FRVBUTC35130	3,5	30	500	1	15,45 €
FRVBUTC40120	4	20	500	1	13,50 €
FRVBUTC40125	4	25	500	1	14,50 €
FRVBUTC40130	4	30	500	1	16,30 €
FRVBUTC50130	5	30	500	1	27,00 €
FRVBUTC50135	5	35	500	1	30,90 €
FRVBUTC50140	5	40	500	1	42,20 €
FRVBUTC50160	5	60	500	1	56,40 €

## VITE TORX TX 30 TRUCIOLARE NERA

Impronta Pozidrive.



Cod.	Ø mm	L mm	Pz	Conf.	Prezzo conf.
063910	5,5	25	500	1	6,14 €
063911	5,5	30	500	1	6,82 €
063912	5,5	35	500	1	7,49 €
063913	5,5	40	500	1	8,30 €

063914	6	25	500	1	8,14 €
063915	6	30	500	1	8,92 €
063916	6	35	500	1	9,87 €
063917	6	40	500	1	10,55 €
063918	6	45	500	1	11,65 €
063919	6	50	500	1	12,55 €

## VITE PER CARTONGESSO

Vite autofilettata con testa a trombeta fosfatata nera. Impronta Phillips. Capacità di foratura 0,6 mm.



Cod.	Ø mm	L mm	Pz	Conf.	Prezzo conf.
FRTROMP35025	3,5	25	1000	1	14,10 €
FRTROMP35035	3,5	35	1000	1	18,05 €
FRTROMP35045	3,5	45	1000	1	22,95 €

## VITE AUTOFILETTANTE PER PROFILI METALLICI VM

Testa a trombeta zincata bianca, impronta Philips.



Cod.	Ø mm	L mm	Conf.	Prezzo conf.
053801	4,2	13	500	15,35 €
053802	4,2	16	500	17,10 €
053803	4,2	19	500	19,30 €
053849	4,2	25	500	22,25 €

## VITE AUTOFILETTANTE CALCESTRUZZO TESTA STRETTA VF



Cod.	Ø mm	L mm	Conf.	Prezzo conf.
030518	7,5	62	100	15,90 €
030519	7,5	72	100	17,85 €
030520	7,5	82	100	21,55 €
038696	7,5	92	100	23,95 €
030532	7,5	102	100	26,40 €
030533	7,5	122	100	32,60 €
057543	7,5	132	100	37,00 €
031203	7,5	152	100	43,70 €
035931	7,5	182	100	67,90 €

## VITE AUTOFILETTANTE CALCESTRUZZO TESTA LARGA VF



Cod.	Ø mm	L mm	Conf.	Prezzo conf.
028462	7,5	52	100	14,40 €
028465	7,5	62	100	16,10 €
028466	7,5	72	100	18,10 €
028467	7,5	82	100	21,75 €
028468	7,5	92	100	24,40 €
028469	7,5	102	100	26,90 €
028470	7,5	122	100	33,30 €
041436	7,5	152	100	44,70 €
041442	7,5	182	100	69,20 €

## VITE TE A LEGNO TIRAFONDO DIN 571 - UNI 704

Zincata bianca.



Cod.	Ø mm	L mm	Descrizione	Conf.	Prezzo
FRTIR06035	6	30	zincata	100	5,33 €
FRTIR06040	6	40	zincata	100	5,64 €
FRTIR06050	6	50	zincata	100	6,69 €
FRTIR06060	6	60	zincata	100	7,73 €
FRTIR06070	6	70	zincata	100	8,88 €
FRTIR06080	6	80	zincata	100	10,15 €
FRTIR06100	6	100	zincata	100	12,65 €
FRTIR08040	8	40	zincata	100	10,55 €
FRTIR08050	8	50	zincata	100	11,95 €
FRTIR08060	8	60	zincata	100	13,70 €
FRTIR08070	8	70	zincata	100	15,35 €
FRTIR08080	8	80	zincata	100	17,25 €
FRTIR08090	8	90	zincata	100	19,45 €
FRTIR08100	8	100	zincata	100	20,80 €
FRTIR08110	8	110	zincata	100	23,00 €
FRTIR08120	8	120	zincata	100	24,55 €
FRTIR08150	8	150	zincata	50	15,70 €
FRTIR08180	8	180	zincata	50	19,85 €
FRTIR08200	8	200	zincata	50	22,70 €
FRTIR08250	8	250	zincata	50	30,60 €
FRTIR10050	10	50	zincata	100	21,65 €
FRTIR10060	10	60	zincata	100	24,15 €
FRTIR10070	10	70	zincata	50	13,15 €
FRTIR10080	10	80	zincata	50	14,55 €
FRTIR10090	10	90	zincata	50	16,55 €
FRTIR10100	10	100	zincata	50	17,65 €
FRTIR10110	10	110	zincata	50	19,30 €
FRTIR10120	10	120	zincata	50	20,70 €
FRTIR10130	10	130	zincata	50	22,15 €
FRTIR10140	10	140	zincata	50	23,80 €
FRTIR10150	10	150	zincata	50	25,10 €
FRTIR10160	10	160	zincata	50	27,40 €
FRTIR10180	10	180	zincata	50	30,30 €
FRTIR10200	10	200	zincata	50	35,50 €
FRTIR10250	10	250	zincata	50	47,60 €
FRTIR10280	10	280	zincata	50	54,90 €
FRTIR10300	10	300	zincata	50	59,00 €

## VITE TER A LEGNO

Materiale acciaio.

Rivestimento zincata bianca.

Testa Te con collare bombato Ø 10,5.

Chiave 10. Passo 2,6.

Utilizzo supp. legno.



Cod.	Ø mm	L mm	Descrizione	Conf.	Prezzo
FRVLO6030	6	30	zincata	200	16,80 €
FRVLO6040	6	40	zincata	200	17,90 €
FRVLO6050	6	50	zincata	200	20,35 €
FRVLO6060	6	60	zincata	200	22,45 €
FRVLO6070	6	70	zincata	100	12,95 €
FRVLO6080	6	80	zincata	100	15,40 €
FRVLO6090	6	90	zincata	100	17,45 €
FRVLO6100	6	100	zincata	100	17,95 €
FRVLO6110	6	110	zincata	100	18,50 €
FRVLO6120	6	120	zincata	100	21,05 €
FRVLO6130	6	130	zincata	100	23,95 €
FRVLO6140	6	140	zincata	100	28,15 €
FRVLO6150	6	150	zincata	100	29,65 €
FRVLO6160	6	160	zincata	100	45,80 €
FRVLO6180	6	180	zincata	100	54,60 €
FRVLO6200	6	200	zincata	100	62,20 €

## VITE AUTOFILETTANTE AF-STEEL DIN 7981



Materiale acciaio cementato. Testa TBC.

Impronta phillips. Passo DIN 7970.

Preforo UNI 6946-71.



Cod.	Ø mm	L mm	Descrizione	Conf.	Prezzo conf.
FRAFST29006	2,9	6,5	zincata	1000	10,15 €
FRAFST29009	2,9	9,5	zincata	1000	10,45 €
FRAFST29013	2,9	13	zincata	1000	10,95 €
FRAFST29016	2,9	16	zincata	500	6,14 €
FRAFST29019	2,9	19	zincata	500	6,76 €
FRAFST29022	2,9	22	zincata	500	7,65 €
FRAFST29025	2,9	25	zincata	500	7,74 €
FRAFST29032	2,9	32	zincata	500	12,60 €
FRAFST35006	3,5	6,5	zincata	500	6,76 €
FRAFST35009	3,5	9,5	zincata	500	6,76 €
FRAFST35013	3,5	13	zincata	500	6,81 €
FRAFST35016	3,5	16	zincata	500	7,38 €
FRAFST35019	3,5	19	zincata	500	7,96 €
FRAFST35022	3,5	22	zincata	500	8,81 €
FRAFST35025	3,5	25	zincata	500	9,52 €
FRAFST35032	3,5	32	zincata	500	11,80 €
FRAFST35038	3,5	38	zincata	200	5,62 €
FRAFST35045	3,5	45	zincata	200	8,40 €
FRAFST35050	3,5	50	zincata	200	11,10 €
FRAFST39006	3,9	6,5	zincata	500	7,48 €
FRAFST39009	3,9	9,5	zincata	500	7,48 €
FRAFST39013	3,9	13	zincata	500	7,79 €
FRAFST39016	3,9	16	zincata	500	8,50 €
FRAFST39019	3,9	19	zincata	500	9,57 €
FRAFST39022	3,9	22	zincata	500	10,65 €
FRAFST39025	3,9	25	zincata	500	11,75 €
FRAFST39032	3,9	32	zincata	500	13,65 €
FRAFST39038	3,9	38	zincata	200	6,87 €
FRAFST39045	3,9	45	zincata	200	9,18 €
FRAFST39050	3,9	50	zincata	200	13,05 €
FRAFST42009	4,2	9,5	zincata	500	8,81 €
FRAFST42013	4,2	13	zincata	500	8,81 €
FRAFST42016	4,2	16	zincata	500	10,05 €
FRAFST42019	4,2	19	zincata	500	11,30 €
FRAFST42022	4,2	22	zincata	500	12,45 €
FRAFST42025	4,2	25	zincata	500	13,75 €
FRAFST42032	4,2	32	zincata	500	16,00 €
FRAFST42038	4,2	38	zincata	200	8,02 €
FRAFST42045	4,2	45	zincata	200	10,75 €
FRAFST42050	4,2	50	zincata	200	13,85 €
FRAFST48009	4,8	9,5	zincata	500	12,55 €
FRAFST48013	4,8	13	zincata	500	12,55 €
FRAFST48016	4,8	16	zincata	500	14,00 €
FRAFST48019	4,8	19	zincata	500	15,35 €
FRAFST48022	4,8	22	zincata	500	16,25 €
FRAFST48025	4,8	25	zincata	500	18,25 €
FRAFST48032	4,8	32	zincata	200	9,04 €
FRAFST48038	4,8	38	zincata	200	10,40 €
FRAFST48045	4,8	45	zincata	200	13,00 €
FRAFST48050	4,8	50	zincata	200	15,65 €
FRAFSS55016	5,5	16	zincata	200	7,52 €
FRAFSS55019	5,5	19	zincata	200	8,41 €
FRAFSS55022	5,5	22	zincata	200	9,82 €
FRAFSS55025	5,5	25	zincata	200	10,75 €
FRAFSS55032	5,5	32	zincata	200	13,35 €
FRAFSS55038	5,5	38	zincata	200	14,95 €
FRAFSS55045	5,5	45	zincata	200	18,45 €
FRAFSS55050	5,5	50	zincata	200	22,75 €
FRAFSS63016	6,3	16	zincata	200	10,95 €
FRAFSS63019	6,3	19	zincata	200	11,95 €
FRAFSS63022	6,3	22	zincata	200	10,40 €
FRAFSS63025	6,3	25	zincata	200	14,40 €
FRAFSS63032	6,3	32	zincata	200	18,25 €

## VITE AUTOFILETTANTE AF-STEEL DIN 7982



Materiale acciaio cementato.  
Rivestimento zincato bianco.  
Testa TPS. Impronta phillips.  
Passo DIN 7970. Utilizzo  
supporto metallici.  
Preforo UNI 6946-71.



Cod.	Ø mm	L mm	Descrizione	Conf.	Prezzo conf.
FRAFSS29006	2,9	6,5	zincata	1000	11,15 €
FRAFSS29009	2,9	9,5	zincata	1000	11,25 €
FRAFSS29013	2,9	13	zincata	1000	12,30 €
FRAFSS29016	2,9	16	zincata	500	6,54 €
FRAFSS29019	2,9	19	zincata	500	7,16 €
FRAFSS29022	2,9	22	zincata	500	8,14 €
FRAFSS29025	2,9	25	zincata	500	8,37 €
FRAFSS29032	2,9	32	zincata	500	13,60 €

FRAFSS35009	3,5	9,5	zincata	500	6,76 €
FRAFSS35013	3,5	13	zincata	500	7,16 €
FRAFSS35016	3,5	16	zincata	500	7,56 €
FRAFSS35019	3,5	19	zincata	500	8,05 €
FRAFSS35022	3,5	22	zincata	500	9,70 €
FRAFSS35025	3,5	25	zincata	500	10,05 €
FRAFSS35032	3,5	32	zincata	500	12,75 €
FRAFSS35038	3,5	38	zincata	200	6,17 €
FRAFSS35045	3,5	45	zincata	200	9,58 €
FRAFSS35050	3,5	50	zincata	200	13,00 €

FRAFSS39009	3,9	9,5	zincata	500	7,56 €
FRAFSS39013	3,9	13	zincata	500	8,01 €
FRAFSS39016	3,9	16	zincata	500	8,54 €
FRAFSS39019	3,9	19	zincata	500	9,65 €
FRAFSS39022	3,9	22	zincata	500	11,65 €
FRAFSS39025	3,9	25	zincata	500	11,90 €
FRAFSS39032	3,9	32	zincata	500	14,90 €
FRAFSS39038	3,9	38	zincata	200	7,42 €
FRAFSS39045	3,9	45	zincata	200	10,10 €
FRAFSS39050	3,9	50	zincata	200	14,60 €

FRAFSS42009	4,2	9,5	zincata	500	8,54 €
FRAFSS42013	4,2	13	zincata	500	9,34 €
FRAFSS42016	4,2	16	zincata	500	10,05 €
FRAFSS42019	4,2	19	zincata	500	10,40 €
FRAFSS42022	4,2	22	zincata	500	12,60 €
FRAFSS42025	4,2	25	zincata	500	12,95 €
FRAFSS42032	4,2	32	zincata	500	17,20 €
FRAFSS42038	4,2	38	zincata	200	8,22 €
FRAFSS42045	4,2	45	zincata	200	10,95 €
FRAFSS42050	4,2	50	zincata	200	14,95 €

FRAFSS48013	4,8	13	zincata	500	12,75 €
FRAFSS48016	4,8	16	zincata	500	13,75 €
FRAFSS48019	4,8	19	zincata	500	15,05 €
FRAFSS48022	4,8	22	zincata	500	16,10 €
FRAFSS48025	4,8	25	zincata	500	17,00 €
FRAFSS48032	4,8	32	zincata	200	9,58 €
FRAFSS48038	4,8	38	zincata	200	9,82 €
FRAFSS48045	4,8	45	zincata	200	18,25 €
FRAFSS48050	4,8	50	zincata	200	20,00 €

## VITE AUTOFILETTANTE AFM PER METALLO



Materiale acciaio cementato.  
Rivestimento zincato bianco.  
Testa Te con collare bombato Ø 15.  
Chiave 10. Passo 1,81.  
Utilizzo supp. metallici sp. >= 01,5 mm.

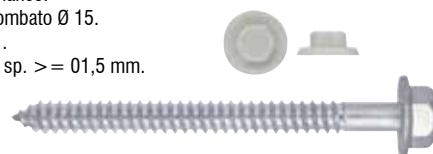

Cod.	Ø mm	L mm	Descrizione	Conf.	Prezzo conf.
FRAFMM06050	6,3	50	zincata	200	30,70 €
FRAFMM06060	6,3	60	zincata	200	35,70 €
FRAFMM06070	6,3	70	zincata	100	20,65 €
FRAFMM06080	6,3	80	zincata	100	22,85 €
FRAFMM06090	6,3	90	zincata	100	25,70 €
FRAFMM06100	6,3	100	zincata	100	28,55 €
FRAFMM06110	6,3	110	zincata	100	31,20 €
FRAFMM06120	6,3	120	zincata	100	33,70 €
FRAFMM06130	6,3	130	zincata	100	39,10 €
FRAFMM06140	6,3	140	zincata	100	46,50 €
FRAFMM06150	6,3	150	zincata	100	54,50 €
FRAFMM06160	6,3	160	zincata	100	63,30 €
FRAFMM06170	6,3	170	zincata	100	79,70 €
FRAFMM06180	6,3	180	zincata	100	90,20 €
FRAFMM06190	6,3	190	zincata	100	74,10 €
FRAFMM06200	6,3	200	zincata	100	109,50 €

## VITE AUTOPERFORANTE AP-STEEL DIN 7504 N TESTA CROCE BOMBATA



Materiale acciaio cementato.  
Rivestimento zincato bianco.  
Testa TCB. Impronta phillips.  
Passo DIN 7970.  
Utilizzo supp. metallici 0,7 ÷ 4,4 mm.  
Avvitatore 2.000 giri/min.



Cod.	Ø mm	L mm	Descrizione	Conf.	Prezzo conf.
FRAPST35009	3,5	9,5	zincata	500	15,35 €
FRAPST35013	3,5	13	zincata	500	15,50 €
FRAPST35016	3,5	16	zincata	500	15,70 €
FRAPST35019	3,5	19	zincata	500	16,20 €
FRAPST35022	3,5	22	zincata	500	18,05 €
FRAPST35025	3,5	25	zincata	500	18,20 €
FRAPST35032	3,5	32	zincata	500	21,35 €
FRAPST35038	3,5	38	zincata	200	9,47 €

FRAPST39009	3,9	9,5	zincata	500	16,10 €
FRAPST39013	3,9	13	zincata	500	16,90 €
FRAPST39016	3,9	16	zincata	500	17,20 €
FRAPST39019	3,9	19	zincata	500	18,00 €
FRAPST39022	3,9	22	zincata	500	20,05 €
FRAPST39025	3,9	25	zincata	500	21,05 €
FRAPST39032	3,9	32	zincata	500	22,95 €
FRAPST39038	3,9	38	zincata	200	10,50 €

FRAPST42013	4,2	13	zincata	500	19,80 €
FRAPST42016	4,2	16	zincata	500	20,05 €
FRAPST42019	4,2	19	zincata	500	20,30 €
FRAPST42022	4,2	22	zincata	500	24,00 €
FRAPST42025	4,2	25	zincata	500	24,30 €
FRAPST42032	4,2	32	zincata	500	25,15 €
FRAPST42038	4,2	38	zincata	200	13,10 €
FRAPST42045	4,2	45	zincata	200	14,40 €
FRAPST42050	4,2	50	zincata	200	15,75 €

FRAPST48013	4,8	13	zincata	500	24,25 €
FRAPST48016	4,8	16	zincata	500	24,75 €
FRAPST48019	4,8	19	zincata	500	25,00 €
FRAPST48022	4,8	22	zincata	500	28,00 €
FRAPST48025	4,8	25	zincata	500	28,20 €
FRAPST48032	4,8	32	zincata	500	13,40 €
FRAPST48038	4,8	38	zincata	500	17,20 €
FRAPST48045	4,8	45	zincata	500	18,25 €
FRAPST48050	4,8	50	zincata	200	21,80 €
FRAPST48060	4,8	60	zincata	100	13,90 €
FRAPST48070	4,8	70	zincata	100	15,65 €

FRAPST55025	5,5	25	zincata	200	20,00 €
FRAPST55032	5,5	32	zincata	200	23,50 €
FRAPST55038	5,5	38	zincata	200	26,05 €
FRAPST55045	5,5	45	zincata	200	28,55 €
FRAPST55050	5,5	40	zincata	200	31,70 €
FRAPST55060	5,5	60	zincata	100	19,40 €
FRAPST55070	5,5	70	zincata	100	21,80 €



## VITE AUTOPERFORANTE AP-STEEL DIN 7504 N TESTA PIANA SVASATA

Materiale acciaio cementato.  
Rivestimento zincato bianco.  
Testa TPS. Impronta phillips.  
Passo DIN 7970. Utilizzo  
supp. metallici 0,7 ÷ 4,4 mm.  
Avvitatore 2.000 giri/min.



Cod.	Ø mm	L mm	Descrizione	Conf.	Prezzo conf.
FRAPSS35013	3,5	13	zincata	500	16,45 €
FRAPSS35016	3,5	16	zincata	500	16,85 €
FRAPSS35019	3,5	19	zincata	500	16,90 €
FRAPSS35022	3,5	22	zincata	500	18,20 €
FRAPSS35025	3,5	25	zincata	500	19,80 €
FRAPSS35032	3,5	32	zincata	200	21,30 €
FRAPSS35038	3,5	38	zincata	200	10,35 €

FRAPSS39013	3,9	13	zincata	500	17,40 €
FRAPSS39016	3,9	16	zincata	500	18,20 €
FRAPSS39019	3,9	19	zincata	500	19,80 €
FRAPSS39022	3,9	22	zincata	500	20,30 €
FRAPSS39025	3,9	25	zincata	500	22,45 €
FRAPSS39032	3,9	32	zincata	200	10,25 €
FRAPSS39038	3,9	38	zincata	200	13,20 €

FRAPSS42013	4,2	13	zincata	500	20,40 €
FRAPSS42016	4,2	16	zincata	500	20,55 €
FRAPSS42019	4,2	19	zincata	500	21,05 €
FRAPSS42022	4,2	22	zincata	500	24,70 €
FRAPSS42025	4,2	25	zincata	500	24,90 €
FRAPSS42032	4,2	32	zincata	500	26,70 €
FRAPSS42038	4,2	38	zincata	200	13,10 €
FRAPSS42045	4,2	45	zincata	200	15,85 €
FRAPSS42050	4,2	50	zincata	200	18,20 €

FRAPSS48016	4,8	16	zincata	500	26,05 €
FRAPSS48019	4,8	19	zincata	500	27,45 €
FRAPSS48022	4,8	22	zincata	500	30,50 €
FRAPSS48025	4,8	25	zincata	500	32,30 €
FRAPSS48032	4,8	32	zincata	200	14,00 €
FRAPSS48038	4,8	38	zincata	200	15,50 €
FRAPSS48045	4,8	45	zincata	200	19,70 €
FRAPSS48050	4,8	50	zincata	200	23,05 €
FRAPSS48060	4,8	60	zincata	100	14,45 €
FRAPSS48070	4,8	70	zincata	100	16,55 €

FRAPSS55025	5,5	25	zincata	200	17,05 €
FRAPSS55032	5,5	32	zincata	200	20,85 €
FRAPSS55038	5,5	38	zincata	200	23,65 €
FRAPSS55045	5,5	45	zincata	200	26,05 €
FRAPSS55050	5,5	40	zincata	200	28,55 €
FRAPSS55060	5,5	60	zincata	100	17,15 €
FRAPSS55070	5,5	70	zincata	100	20,45 €

## VITE AUTOPERFORANTE AP4 FORO MAX 4 MM UNI EN ISO 15480

Materiale in acciaio cementato.  
Rivestimento zincato bianco.  
Testa TE con collare piatto Ø 10,5.  
Chiave 8. Passo 1,6.  
Utilizzo supporto metallici 1,5 ÷ 4 mm.  
Avvitatore 2000 giri/min.  
Rondella zincata / ePDM Ø 16x5,1.

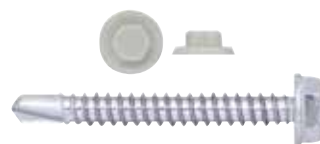

Cod.	Ø mm	L mm	Descrizione	Conf.	Prezzo conf.
FRAP404013	4,8	13	zincata	200	9,50 €
FRAP404016	4,8	16	zincata	200	10,15 €
FRAP404019	4,8	19	zincata	200	10,80 €
FRAP404022	4,8	22	zincata	200	12,20 €
FRAP404025	4,8	25	zincata	200	12,50 €
FRAP404032	4,8	32	zincata	200	14,40 €
FRAP404038	4,8	38	zincata	200	17,55 €
FRAP404045	4,8	45	zincata	200	19,65 €

FRAP505016	5,5	16	zincata	200	14,10 €
FRAP505019	5,5	19	zincata	200	14,40 €
FRAP505025	5,5	25	zincata	200	17,10 €
FRAP505032	5,5	32	zincata	200	19,70 €
FRAP505038	5,5	38	zincata	200	21,20 €
FRAP505050	5,5	50	zincata	200	14,10 €
FRAP505060	5,5	60	zincata	200	16,35 €

## VITE AUTOPERFORANTE AP6 FORO MAX 6 MM UNI EN ISO 15480

Materiale in acciaio cementato.  
Rivestimento zincato bianco.  
Testa TE con collare piatto Ø 12,5.  
Chiave 10. Passo 1,81.  
Utilizzo supporto metallici 2 ÷ 6 mm.  
Avvitatore 1500 giri/min.



Cod.	Ø mm	L mm	Descrizione	Conf.	Prezzo conf.
FRAP606019	6,3	19	zincata	200	16,20 €
FRAP606022	6,3	22	zincata	200	18,30 €
FRAP606025	6,3	25	zincata	200	18,70 €
FRAP606032	6,3	32	zincata	200	20,35 €
FRAP606038	6,3	38	zincata	200	21,20 €
FRAP606045	6,3	45	zincata	200	22,00 €
FRAP606050	6,3	50	zincata	200	25,00 €
FRAP606060	6,3	60	zincata	200	29,05 €
FRAP606070	6,3	70	zincata	100	17,00 €
FRAP606080	6,3	80	zincata	100	18,85 €
FRAP606090	6,3	90	zincata	100	20,65 €
FRAP606100	6,3	100	zincata	100	23,25 €
FRAP606110	6,3	110	zincata	100	24,55 €
FRAP606120	6,3	120	zincata	100	26,70 €
FRAP606130	6,3	130	zincata	100	30,80 €
FRAP606140	6,3	140	zincata	100	41,30 €
FRAP606150	6,3	150	zincata	100	45,70 €
FRAP606160	6,3	160	zincata	100	53,90 €
FRAP606180	6,3	180	zincata	100	72,40 €
FRAP606200	6,3	200	zincata	100	98,00 €

## CHIEDO CON FILETTO RULLATO CH

Testa ad ombrello. Zincato bianco.  
Rondella in poliestere.



Cod.	Ø mm	L mm	Descrizione	Conf.	Prezzo
FRCHZB38040	4,3	40	zincato	200	24,90 €
FRCHZB38050	4,3	50	zincato	200	25,85 €
FRCHZB38060	4,3	60	zincato	200	27,20 €
FRCHZB38070	4,3	70	zincato	200	28,10 €
FRCHZB38080	4,3	80	zincato	200	29,95 €

**RONDELLA GOMMA E INOX RG**



Cod.	mm	Pz	Conf.	Prezzo
040882	19x6,7	100	1	24,50 €
032535	29x6,7	100	1	51,60 €

**RONDELLA GOMMA E ALLUMINIO RG**



Cod.	mm	Pz	Conf.	Prezzo
038292	19x6,7	100	1	19,25 €
038293	25x6,7	100	1	32,60 €
026712	29x6,7	100	1	41,80 €

**RONDELLA NYLON PER POLICARBONATO CON TAPPO RPC**



Cod.	mm	Pz	Conf.	Prezzo
027495	6x48	100	1	119,50 €

**RONDELLA NYLON TONDA**



Cod.	mm	Pz	Descrizione	Conf.	Prezzo
FRRPA16000	6x15	100	trasparente	1	2,17 €
012388	4,5	200	-	1	4,22 €

**RONDELLA ROMBOIDALE RG**



Cod.	Ø mm	Dim. mm	Descrizione	Conf.	Prezzo conf.
FRRG27027Z	6,5	27x27	prezincata	100	3,90 €
FRRG27027P	6	27x27	polietilene	100	2,64 €

**RONDELLA RG CONICA INOX CON GUARNIZIONE BAZ**



Cod.	Pz	Conf.	Prezzo
024705	100	1	23,95 €

**BARRETTA FILETTATA CON RONDELLA E DADO BRT**



Cod.	mm	Pz	Conf.	Prezzo
004810	6x120	100	1	40,00 €
004811	6x150	100	1	43,50 €
008643	6x200	100	1	51,40 €
004812	6x250	100	1	58,20 €
008644	6x300	100	1	70,70 €

**BULLONE CARRAIO CL. 4.8 - DIN 603**



Cod.	Ø mm	L mm	Descrizione	Conf.	Prezzo
FRTDQZB05020	5	20	zincato	500	29,45 €
FRTDQZB05025	5	25	zincato	500	32,40 €
FRTDQZB05030	5	30	zincato	500	34,10 €
FRTDQZB05035	5	35	zincato	200	15,25 €
FRTDQZB05040	5	40	zincato	200	16,20 €
FRTDQZB05045	5	45	zincato	200	17,10 €
FRTDQZB05050	5	50	zincato	200	18,75 €
FRTDQZB05055	5	55	zincato	200	19,90 €
FRTDQZB05060	5	60	zincato	200	21,25 €
FRTDQZB05070	5	70	zincato	200	23,10 €
FRTDQZB06016	6	16	zincato	500	41,60 €
FRTDQZB06020	6	20	zincato	500	41,00 €
FRTDQZB06025	6	25	zincato	500	44,50 €
FRTDQZB06030	6	30	zincato	500	46,80 €
FRTDQZB06035	6	35	zincato	200	20,35 €
FRTDQZB06040	6	40	zincato	200	21,75 €
FRTDQZB06045	6	45	zincato	200	23,55 €
FRTDQZB06050	6	50	zincato	200	24,75 €
FRTDQZB06060	6	60	zincato	200	28,20 €
FRTDQZB06070	6	70	zincato	200	31,70 €
FRTDQZB06080	6	80	zincato	200	34,90 €
FRTDQZB06090	6	90	zincato	100	19,75 €
FRTDQZB06100	6	100	zincato	100	21,75 €
FRTDQZB08016	8	16	zincato	200	32,60 €
FRTDQZB08020	8	20	zincato	200	31,70 €
FRTDQZB08025	8	25	zincato	200	33,80 €
FRTDQZB08030	8	30	zincato	200	35,60 €
FRTDQZB08035	8	35	zincato	200	38,40 €
FRTDQZB08040	8	40	zincato	200	40,20 €
FRTDQZB08045	8	45	zincato	200	42,50 €
FRTDQZB08050	8	50	zincato	200	45,30 €
FRTDQZB08060	8	60	zincato	200	51,30 €
FRTDQZB08070	8	70	zincato	200	54,80 €
FRTDQZB08080	8	80	zincato	200	59,80 €
FRTDQZB08090	8	90	zincato	100	33,90 €
FRTDQZB08100	8	100	zincato	100	36,00 €
FRTDQZB08110	8	110	zincato	100	38,50 €
FRTDQZB08120	8	120	zincato	100	40,60 €
FRTDQZB08130	8	130	zincato	100	42,90 €
FRTDQZB08140	8	140	zincato	50	22,95 €
FRTDQZB08150	8	150	zincato	50	25,15 €
FRTDQZB08160	8	160	zincato	50	26,30 €
FRTDQZB08170	8	170	zincato	50	28,55 €
FRTDQZB08180	8	180	zincato	50	30,60 €
FRTDQZB10040	10	40	zincato	100	32,90 €
FRTDQZB10050	10	50	zincato	100	36,80 €
FRTDQZB10060	10	60	zincato	100	39,50 €
FRTDQZB10070	10	70	zincato	100	43,70 €
FRTDQZB10080	10	80	zincato	100	48,30 €
FRTDQZB10090	10	90	zincato	100	53,70 €
FRTDQZB10100	10	100	zincato	100	57,90 €
FRTDQZB10110	10	110	zincato	50	32,20 €
FRTDQZB10120	10	120	zincato	50	33,80 €
FRTDQZB10130	10	130	zincato	50	35,80 €
FRTDQZB10150	10	150	zincato	50	39,90 €
FRTDQZB10160	10	160	zincato	50	41,60 €
FRTDQZB10170	10	170	zincato	50	47,60 €
FRTDQZB10180	10	180	zincato	50	50,60 €
FRTDQZB10200	10	200	zincato	50	54,90 €

# FM WOOD PRO

## VITE PORTANTE PER LEGNO



ELEVATA VELOCITÀ  
D'INSERIMENTO



BASSA COPPIA  
IN AVVITAMENTO



CAPACITÀ DI PIEGATURA  
OLTRE 90°



**FRIULSIDER**  
YOUR FIXING FACTORY

## VITE BRUGOLA TC 8.8 DIN912-UNI5931

Filettatura metrica ISO a passo grosso.  
Testa con esagono incassato.  
Classe 8.8.



Cod.	Ø mm	L mm	Descrizione	Conf.	Prezzo %
B050593104010	4	10	zincata	500	4,72 €
B050593104016	4	16	zincata	500	4,33 €
B050593104020	4	20	zincata	500	4,67 €
B050593104025	4	25	zincata	500	5,44 €
B050593104030	4	30	zincata	500	6,11 €
B050593104035	4	35	zincata	500	8,11 €
B050593104040	4	40	zincata	500	10,90 €
B010573905050	5	50	zincata	500	9,08 €
B050593105010	5	10	zincata	500	4,72 €
B050593105016	5	16	zincata	500	4,33 €
B050593105020	5	20	zincata	500	4,67 €
B050593105025	5	25	zincata	500	5,44 €
B050593105030	5	30	zincata	500	6,11 €
B050593105035	5	35	zincata	500	6,50 €
B050593105040	5	40	zincata	500	8,11 €
B050593105050	5	50	zincata	500	10,90 €
B050593105060	5	60	zincata	500	13,85 €
B050593106010	6	10	zincata	500	6,33 €
B050593106016	6	16	zincata	500	5,78 €
B050593106020	6	20	zincata	500	6,66 €
B050593106025	6	25	zincata	500	7,50 €
B050593106030	6	30	zincata	500	8,16 €
B050593106035	6	35	zincata	200	9,33 €
B050593106040	6	40	zincata	200	10,40 €
B050593106050	6	50	zincata	200	13,85 €
B050593106060	6	60	zincata	200	17,60 €
B050593106070	6	70	zincata	200	22,40 €
B050593106080	6	80	zincata	200	29,00 €
B050593108016	8	16	zincata	200	10,40 €
B050593108020	8	20	zincata	200	10,95 €
B050593108025	8	25	zincata	200	12,10 €
B050593108030	8	30	zincata	200	13,50 €
B050593108035	8	35	zincata	200	16,10 €
B050593108040	8	40	zincata	200	17,15 €
B050593108050	8	50	zincata	200	19,65 €
B050593108060	8	60	zincata	100	22,55 €
B050593108070	8	70	zincata	100	27,10 €
B050593108080	8	80	zincata	100	33,40 €
B050593108090	8	90	zincata	100	41,50 €
B050593108100	8	100	zincata	100	48,60 €
B050593108110	8	110	zincata	100	54,10 €
B050593108120	8	120	zincata	50	59,10 €
B050593110020	10	20	zincata	200	21,05 €
B050593110025	10	25	zincata	200	23,10 €
B050593110030	10	30	zincata	200	24,95 €
B050593110035	10	35	zincata	100	26,65 €
B050593110040	10	40	zincata	100	28,55 €
B050593110050	10	50	zincata	100	32,70 €
B050593110060	10	60	zincata	100	37,20 €
B050593110070	10	70	zincata	50	43,80 €
B050593110080	10	80	zincata	50	50,60 €
B050593110090	10	90	zincata	50	57,20 €
B050593110100	10	100	zincata	50	64,30 €
B050593110110	10	110	zincata	50	73,40 €
B050593110120	10	120	zincata	50	83,40 €
B050593112025	12	25	zincata	100	31,60 €
B050593112030	12	30	zincata	100	34,30 €
B050593112035	12	35	zincata	100	36,80 €
B050593112040	12	40	zincata	100	38,90 €
B050593112060	12	60	zincata	50	52,10 €
B050593112070	12	70	zincata	50	62,30 €
B050593112090	12	90	zincata	50	81,60 €
B050593112100	12	100	zincata	50	96,10 €
B050593112110	12	110	zincata	50	109,50 €
B050593112120	12	120	zincata	50	123,50 €

## VITE ACCIAIO TE 8.8 DIN933-UNI5739

Filettatura metrica ISO a passo grosso.  
Gambo interamente filettato.  
Classe 8.8.

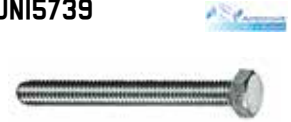

Cod.	Ø mm	L mm	Descrizione	Conf.	Prezzo %
B010573905010	5	10	zincata	500	4,80 €
B010573905016	5	16	zincata	500	4,23 €
B010573905020	5	20	zincata	500	4,32 €
B010573905025	5	25	zincata	500	4,85 €
B010573905030	5	30	zincata	500	5,19 €
B010573905035	5	35	zincata	500	5,62 €
B010573905040	5	40	zincata	500	6,77 €
B010573905050	5	50	zincata	500	9,08 €
B010573906010	6	10	zincata	500	4,95 €
B010573906012	6	12	zincata	500	4,47 €
B010573906016	6	16	zincata	500	4,66 €
B010573906020	6	20	zincata	500	5,33 €
B010573906025	6	25	zincata	500	5,91 €
B010573906030	6	30	zincata	500	6,68 €
B010573906035	6	35	zincata	200	7,11 €
B010573906040	6	40	zincata	200	7,88 €
B010573906045	6	45	zincata	200	8,60 €
B010573906050	6	50	zincata	200	8,60 €
B010573906060	6	60	zincata	200	13,10 €
B010573906070	6	70	zincata	200	16,75 €
B010573906080	6	80	zincata	200	21,60 €
B010573906090	6	90	zincata	200	21,70 €
B010573906100	6	100	zincata	200	21,95 €
B010573908016	8	16	zincata	200	8,55 €
B010573908020	8	20	zincata	200	9,46 €
B010573908025	8	25	zincata	200	10,60 €
B010573908030	8	30	zincata	200	11,70 €
B010573908035	8	35	zincata	200	12,90 €
B010573908040	8	40	zincata	200	14,05 €
B010573908045	8	45	zincata	200	15,35 €
B010573908050	8	50	zincata	200	16,40 €
B010573908060	8	60	zincata	100	19,30 €
B010573908070	8	70	zincata	100	24,80 €
B010573908080	8	80	zincata	100	28,60 €
B010573908090	8	90	zincata	100	32,50 €
B010573908100	8	100	zincata	100	37,60 €
B010573910016	10	16	zincata	200	16,95 €
B010573910020	10	20	zincata	200	18,35 €
B010573910025	10	25	zincata	200	19,95 €
B010573910030	10	30	zincata	200	21,70 €
B010573910035	10	35	zincata	100	23,30 €
B010573910040	10	40	zincata	100	24,75 €
B010573910045	10	45	zincata	100	26,65 €
B010573910050	10	50	zincata	100	28,20 €
B010573910060	10	60	zincata	100	32,10 €
B010573910070	10	70	zincata	100	38,80 €
B010573910080	10	80	zincata	50	44,50 €
B010573910090	10	90	zincata	50	52,80 €
B010573910100	10	100	zincata	50	61,20 €
B010573912020	12	20	zincata	100	26,25 €
B010573912025	12	25	zincata	100	28,65 €
B010573912030	12	30	zincata	100	31,20 €
B010573912035	12	35	zincata	100	33,60 €
B010573912040	12	40	zincata	100	35,60 €
B010573912045	12	45	zincata	100	38,40 €
B010573912050	12	50	zincata	50	40,50 €
B010573912060	12	60	zincata	50	45,40 €
B010573912070	12	70	zincata	50	55,70 €
B010573912080	12	80	zincata	50	64,00 €
B010573912090	12	90	zincata	50	73,20 €
B010573912100	12	100	zincata	50	84,70 €
B010573914030	14	30	zincata	50	49,20 €
B010573914040	14	40	zincata	50	55,20 €
B010573914050	14	50	zincata	50	61,90 €
B010573914060	14	60	zincata	50	67,60 €
B010573914070	14	70	zincata	50	75,90 €
B010573914080	14	80	zincata	25	86,40 €
B010573914090	14	90	zincata	25	100,00 €
B010573914100	14	100	zincata	25	118,00 €



Cod.	Ø mm	L mm	Descrizione	Conf.	Prezzo %
B010573916030	16	30	zincata	50	60,20 €
B010573916040	16	40	zincata	50	66,40 €
B010573916045	16	45	zincata	50	70,90 €
B010573916050	16	50	zincata	25	74,60 €
B010573916060	16	60	zincata	25	85,70 €
B010573916065	16	65	zincata	25	92,90 €
B010573916070	16	70	zincata	25	97,90 €
B010573916080	16	80	zincata	25	113,50 €
B010573916090	16	90	zincata	25	125,00 €
B010573916100	16	100	zincata	25	142,50 €
B010573918040	18	40	zincata	25	114,50 €
B010573918050	18	50	zincata	25	128,00 €
B010573918060	18	60	zincata	25	142,50 €
B010573918070	18	70	zincata	25	163,00 €
B010573918080	18	80	zincata	25	180,50 €
B010573920040	20	40	zincata	25	114,50 €
B010573920050	20	50	zincata	25	128,00 €
B010573920060	20	60	zincata	25	142,50 €
B010573920070	20	70	zincata	25	163,00 €
B010573920080	20	80	zincata	25	180,50 €

## VITE ACCIAIO TE 8.8 DIN931-UNI5737

Filettatura metrica ISO a passo grosso.  
Gambo parzialmente filettato.  
Classe 8.8.



Cod.	Ø mm	L mm	Descrizione	Conf.	Prezzo %
B010573705030	5	30	zincata	500	5,72 €
B010573705040	5	40	zincata	500	7,44 €
B010573705050	5	50	zincata	500	9,27 €
B010573705060	5	60	zincata	200	12,60 €
B010573706040	6	40	zincata	200	8,55 €
B010573706050	6	50	zincata	200	10,35 €
B010573706060	6	60	zincata	200	12,25 €
B010573706070	6	70	zincata	200	15,50 €
B010573706080	6	80	zincata	200	19,00 €
B010573706090	6	90	zincata	200	24,60 €
B010573706100	6	100	zincata	200	31,30 €
B010573708040	8	40	zincata	200	15,00 €
B010573708050	8	50	zincata	200	17,20 €
B010573708060	8	60	zincata	100	19,55 €
B010573708070	8	70	zincata	100	24,40 €
B010573708080	8	80	zincata	100	29,50 €
B010573708090	8	90	zincata	100	37,10 €
B010573708100	8	100	zincata	100	43,80 €
B010573708110	8	110	zincata	100	46,70 €
B010573708120	8	120	zincata	100	53,10 €
B010573708130	8	130	zincata	100	57,70 €
B010573708140	8	140	zincata	100	62,80 €
B010573708150	8	150	zincata	100	68,70 €
B010573710040	10	40	zincata	100	28,85 €
B010573710045	10	45	zincata	100	28,60 €
B010573710050	10	50	zincata	100	30,50 €
B010573710060	10	60	zincata	100	34,80 €
B010573710070	10	70	zincata	50	41,80 €
B010573710080	10	80	zincata	50	48,00 €
B010573710090	10	90	zincata	50	54,10 €
B010573710100	10	100	zincata	50	63,40 €
B010573710110	10	110	zincata	50	73,90 €
B010573710120	10	120	zincata	50	79,80 €
B010573710130	10	130	zincata	50	88,90 €
B010573710140	10	140	zincata	25	101,50 €
B010573710150	10	150	zincata	25	111,00 €



Cod.	Ø mm	L mm	Descrizione	Conf.	Prezzo %
B010573712040	12	40	zincata	50	40,60 €
B010573712050	12	50	zincata	50	43,10 €
B010573712060	12	60	zincata	50	49,60 €
B010573712070	12	70	zincata	50	58,90 €
B010573712080	12	80	zincata	50	67,80 €
B010573712090	12	90	zincata	50	76,40 €
B010573712100	12	100	zincata	50	89,40 €
B010573712110	12	110	zincata	25	101,00 €
B010573712120	12	120	zincata	25	109,00 €
B010573712130	12	130	zincata	25	127,00 €
B010573712140	12	140	zincata	25	143,00 €
B010573712150	12	150	zincata	25	156,00 €
B010573714050	14	50	zincata	50	77,20 €
B010573714060	14	60	zincata	50	77,60 €
B010573714070	14	70	zincata	25	84,70 €
B010573714080	14	80	zincata	25	94,30 €
B010573714090	14	90	zincata	25	102,50 €
B010573714100	14	100	zincata	25	110,50 €
B010573714110	14	110	zincata	25	129,50 €
B010573714120	14	120	zincata	25	149,00 €
B010573714130	14	130	zincata	25	161,50 €
B010573714140	14	140	zincata	25	179,50 €
B010573714150	14	150	zincata	25	200,00 €
B010573716050	16	50	zincata	25	84,10 €
B010573716060	16	60	zincata	25	89,10 €
B010573716065	16	65	zincata	25	94,00 €
B010573716070	16	70	zincata	25	99,80 €
B010573716080	16	80	zincata	25	110,50 €
B010573716090	16	90	zincata	25	122,00 €
B010573716100	16	100	zincata	25	135,00 €
B010573716110	16	110	zincata	25	146,50 €
B010573716120	16	120	zincata	25	161,50 €
B010573716130	16	130	zincata	25	174,50 €
B010573716140	16	140	zincata	25	215,00 €
B010573716150	16	150	zincata	25	229,00 €
B010573716160	16	160	zincata	25	255,50 €
B010573716170	16	170	zincata	25	313,50 €
B010573716180	16	180	zincata	25	313,50 €
B010573716190	16	190	zincata	25	367,50 €
B010573716200	16	200	zincata	25	367,50 €
B010573718060	18	60	zincata	25	159,00 €
B010573718080	18	80	zincata	25	188,50 €
B010573718100	18	100	zincata	25	228,00 €
B010573718120	18	120	zincata	25	270,50 €
B010573718140	18	140	zincata	25	347,00 €
B010573718150	18	150	zincata	25	392,50 €
B010573720100	20	100	zincata	25	228,00 €
B010573720120	20	120	zincata	25	270,50 €
B010573720140	20	140	zincata	25	347,00 €
B010573720150	20	150	zincata	25	392,50 €

## VITE ZINCATA TESTA CILINDRICA A CROCE



Cod.	Ø mm	L mm	Conf.	Prezzo %
029203	3	10	1000	11,20 €
029204	3	16	1000	13,00 €
029205	3	20	1000	14,65 €
029206	3	25	1000	18,30 €
029207	3	30	1000	19,80 €
029208	3	35	1000	22,05 €
029209	3	40	500	13,10 €
029217	4	10	1000	17,40 €
025876	4	16	1000	20,65 €
026212	4	20	1000	21,70 €
026214	4	25	500	12,40 €
026217	4	30	500	14,00 €
026218	4	35	500	15,90 €
026219	4	40	500	17,35 €
026220	4	45	500	19,20 €
026221	4	50	500	21,20 €
026222	4	60	200	10,50 €
026917	5	10	1000	27,85 €
026918	5	16	500	16,60 €
025878	5	20	500	18,60 €
061575	5	25	500	21,00 €
025879	5	30	200	9,60 €
025894	5	35	200	10,60 €
061576	5	40	200	12,25 €
025895	5	50	200	15,60 €
025896	5	60	200	18,50 €
029218	5	70	200	22,10 €
025897	5	80	200	26,40 €
029219	6	10	500	22,50 €
029220	6	16	500	26,80 €
025880	6	20	500	28,20 €
029221	6	25	200	12,50 €
025881	6	30	200	14,65 €
025883	6	35	200	16,35 €
061577	6	40	200	18,25 €
029222	6	50	200	21,40 €
025884	6	60	200	25,20 €
025885	6	70	200	28,80 €
025886	6	80	200	34,80 €
061583	8	16	500	54,00 €
061584	8	20	200	22,80 €
061585	8	25	200	25,95 €
061586	8	30	200	28,80 €
061587	8	40	100	18,00 €

## VITE BRUGOLA TP SVASATA 10.9 DIN7991-UNI5933

Filettatura metrica ISO a passo grosso.  
Testa con esagono incassato.  
Classe 10.9.



Cod.	Ø mm	L mm	Descrizione	Conf.	Prezzo %
B050593304010	4	10	zincata	500	3,94 €
B050593304016	4	16	zincata	500	3,70 €
B050593304020	4	20	zincata	500	3,99 €
B050593304025	4	25	zincata	500	4,56 €
B050593304030	4	30	zincata	500	5,00 €
B050593304040	4	40	zincata	500	6,58 €
B050593305010	5	10	zincata	500	4,37 €
B050593305016	5	16	zincata	500	4,28 €
B050593305020	5	20	zincata	500	4,61 €
B050593305025	5	25	zincata	500	5,43 €
B050593305030	5	30	zincata	500	6,15 €
B050593305040	5	40	zincata	500	9,51 €
B050593305050	5	50	zincata	500	15,85 €
B050593306012	6	12	zincata	200	4,80 €
B050593306016	6	16	zincata	200	5,62 €
B050593306020	6	20	zincata	200	6,53 €
B050593306025	6	25	zincata	200	7,44 €
B050593306030	6	30	zincata	200	8,26 €
B050593306035	6	35	zincata	200	8,16 €
B050593306040	6	40	zincata	200	10,50 €
B050593306050	6	50	zincata	200	13,75 €
B050593306060	6	60	zincata	200	22,75 €
B050593308016	8	16	zincata	200	10,20 €
B050593308020	8	20	zincata	200	11,00 €
B050593308025	8	25	zincata	200	12,25 €
B050593308030	8	30	zincata	200	13,75 €
B050593308035	8	35	zincata	200	16,35 €
B050593308040	8	40	zincata	200	17,50 €
B050593308050	8	50	zincata	200	20,25 €
B050593308060	8	60	zincata	200	23,25 €
B050593310020	10	20	zincata	200	20,50 €
B050593310025	10	25	zincata	200	22,80 €
B050593310030	10	30	zincata	200	24,95 €
B050593310035	10	35	zincata	200	26,95 €
B050593310040	10	40	zincata	200	29,10 €
B050593310050	10	50	zincata	100	33,60 €
B050593310060	10	60	zincata	100	38,50 €
B050593310070	10	70	zincata	100	44,40 €
B050593312025	12	25	zincata	200	37,30 €
B050593312030	12	30	zincata	200	34,90 €
B050593312035	12	35	zincata	100	37,80 €
B050593312040	12	40	zincata	100	40,40 €
B050593312050	12	50	zincata	100	46,90 €
B050593312060	12	60	zincata	100	54,60 €
B050593312070	12	70	zincata	50	63,80 €

## VITE CANNOCCHIALE NYLON BIANCA



Cod.	mm	Descrizione	Conf.	Prezzo %
063920	26/32	bianca	500	0,25 €
063921	30/36	bianca	500	0,25 €
063922	34/40	bianca	500	0,33 €
063923	26/32	marrone	500	0,25 €
063924	30/36	marrone	500	0,25 €
063925	34/40	marrone	500	0,33 €

## VITE CANNOCCHIALE OTTONE



Cod.	mm	Conf.	Prezzo %
063926	40/45	100	1,37 €
063927	45/55	100	1,38 €
063928	50/55	100	1,52 €
063929	60/65	100	2,07 €

## RONDELLA DENTELLATA DIN6798



Cod.	Ø mm	Descrizione	Conf.	Prezzo %
B020679803	3	zincata	2000	16,40 €
B020679804	4	zincata	2000	18,60 €
B020679805	5	zincata	1000	11,65 €
B020679806	6	zincata	1000	15,70 €
B020679808	8	zincata	1000	30,00 €
B020679810	10	zincata	1000	45,20 €
B020679812	12	zincata	1000	78,20 €
B020679814	14	zincata	400	54,10 €
B020679816	16	zincata	500	71,10 €

## RONDELLA PIANA DIN125/A-UNI6592



Cod.	Ø mm	Descrizione	Conf.	Prezzo %
B020659203	3	zincata	5000	13,70 €
B020659204	4	zincata	5000	21,60 €
B020659205	5	zincata	5000	24,50 €
B020659206	6	zincata	2000	17,60 €
B020659208	8	zincata	2000	27,10 €
B020659210	10	zincata	1000	26,65 €
B020659212	12	zincata	500	23,00 €
B020659214	14	zincata	200	13,90 €
B020659216	16	zincata	200	16,65 €
B020659218	18	zincata	200	22,50 €
B020659220	20	zincata	100	13,00 €
B020659222	22	zincata	100	14,20 €
B020659224	24	zincata	100	22,85 €
B020659227	27	zincata	50	15,30 €
B020659230	30	zincata	50	22,30 €

## RONDELLA GREMBIALINA DIN9021-UNI6593



Cod.	Ø mm	Descrizione	Conf.	Prezzo %
B02065930412	4x12	zincata	2500	16,95 €
B02065930416	4x16	zincata	2500	35,00 €
B02065930515	5x15	zincata	2000	25,95 €
B02065930520	5x20	zincata	2000	46,70 €
B02065930618	6x18	zincata	2000	38,40 €
B02065930624	6x24	zincata	1000	39,40 €
B02065930824	8x24	zincata	500	21,10 €
B02065930832	8x32	zincata	250	20,50 €
B02065931030	10x30	zincata	200	15,50 €
B02065931040	10x40	zincata	100	14,75 €
B02065931236	12x36	zincata	200	27,75 €
B02065931248	12x48	zincata	100	27,50 €
B02065931442	14x42	zincata	100	19,30 €
B02065931648	16x48	zincata	100	28,10 €
B02065931854	18x54	zincata	100	37,70 €
B02065932060	20x60	zincata	50	29,35 €

## RONDELLA GROWER DIN127/B-UNI1751



Cod.	Ø mm	Descrizione	Conf.	Prezzo %
B020175104	4	zincata	2000	16,20 €
B020175105	5	zincata	2000	22,15 €
B020175106	6	zincata	1000	11,10 €
B020175108	8	zincata	1000	19,50 €
B020175110	10	zincata	1000	22,10 €
B020175112	12	zincata	1000	37,80 €
B020175114	14	zincata	500	31,70 €
B020175116	16	zincata	500	45,00 €
B020175118	18	zincata	500	57,80 €
B020175120	20	zincata	400	57,10 €

## DADO ESAGONALE MEDIO DIN934-UNI5588

Filettatura metrica ISO passo grosso.  
Classe 8.8.



Cod.	Ø mm	Descrizione	Conf.	Prezzo %
B030558803	3	zincato	1000	4,15 €
B030558804	4	zincato	1000	11,65 €
B030558805	5	zincato	500	15,95 €
B030558806	6	zincato	500	27,60 €
B030558808	8	zincato	500	29,35 €
B030558810	10	zincato	200	31,80 €
B030558812	12	zincato	200	23,75 €
B030558814	14	zincato	200	27,50 €
B030558816	16	zincato	200	38,10 €
B030558818	18	zincato	100	28,50 €
B030558820	20	zincato	100	37,00 €
B030558822	22	zincato	100	52,80 €
B030558824	24	zincato	50	31,00 €
B030558827	27	zincato	25	17,55 €

## DADO ESAGONALE FLANGIATO DENTELLATO

Filettatura metrica ISO passo grosso.



Cod.	Filetto	Conf.	Prezzo
063931	M4	1000	1,58 €
063932	M5	500	1,98 €
063933	M6	500	2,37 €
063934	M8	500	5,14 €
063935	M10	200	8,43 €
063936	M12	200	15,30 €

## DADO ESAGONALE MEDIO DE IN BLISTER

Filettatura metrica ISO passo grosso.  
Classe 8.8.



Cod.	Filetto	Pz	Conf.	Prezzo
035901	M3	25	30	0,64 €
035902	M4	25	30	0,76 €
033347	M5	15	30	0,70 €
033348	M6	15	30	0,89 €
033410	M8	10	30	1,20 €
033411	M10	10	30	2,08 €
035903	M12	10	30	2,97 €
035904	M16	5	30	3,17 €

## DADO AUTOBLOCCANTE DIN982-UNI7473

Filettatura metrica ISO passo grosso.  
Classe 4.8.



Cod.	Ø mm	Descrizione	Conf.	Prezzo %
B030747303	3	zincato	1000	13,40 €
B030747304	4	zincato	1000	16,00 €
B030747305	5	zincato	1000	17,25 €
B030747306	6	zincato	500	13,30 €
B030747308	8	zincato	500	24,90 €
B030747310	10	zincato	500	52,30 €
B030747312	12	zincato	300	46,20 €
B030747314	14	zincato	150	34,70 €
B030747316	16	zincato	100	30,80 €
B030747318	18	zincato	100	22,50 €
B030747320	20	zincato	50	32,10 €

## DADO AUTOBLOCCANTE BLOK IN BLISTER

Filettatura metrica ISO passo grosso.  
Classe 4.8.



Cod.	Filetto	Pz	Conf.	Prezzo
033349	M5	15	30	1,49 €
033350	M6	15	30	1,91 €
033351	M8	10	30	2,11 €
033352	M10	10	30	4,35 €

## DADO CIECO UNI5721

Filettatura metrica ISO passo grosso.  
Classe 8.8.



Cod.	Ø mm	Descrizione	Conf.	Prezzo %
B030572104	4	zincato	100	8,80 €
B030572105	5	zincato	100	46,60 €
B030572106	6	zincato	100	56,40 €
B030572108	8	zincato	100	54,70 €
B030572110	10	zincato	100	42,30 €
B030572112	12	zincato	50	61,80 €

## VITE VSS DOPPIA FILETTATURA

Vite di congiunzione senza schiacciatura.



Cod.	Ø mm	L mm	Descrizione	Conf.	Prezzo
FRVSSZB0640	6	40	zincata	300	55,30 €
FRVSSZB0650	6	50	zincata	300	60,50 €
FRVSSZB0660	6	60	zincata	300	63,50 €
FRVSSZB0670	6	70	zincata	300	67,10 €
FRVSSZB0680	6	80	zincata	300	71,10 €
FRVSSZB0880	8	80	zincata	100	26,30 €
FRVSSZB10100	10	100	zincata	100	44,90 €

## BARRA FILETTATA RULLATA DIN975

Filettatura metrica ISO passo grosso.  
Classe 4.6.



Cod.	Ø mm	L mm	Descrizione	Conf.	Prezzo
B040BARRA03	3	1000	zincata	100	0,73 €
B040BARRA04	4	1000	zincata	100	0,81 €
B040BARRA05	5	1000	zincata	100	0,95 €
B040BARRA06	6	1000	zincata	100	0,91 €
B040BARRA08	8	1000	zincata	50	1,33 €
B040BARRA10	10	1000	zincata	25	2,00 €
B040BARRA12	12	1000	zincata	25	2,70 €
B040BARRA14	14	1000	zincata	20	3,56 €
B040BARRA16	16	1000	zincata	10	5,13 €
B040BARRA18	18	1000	zincata	10	6,65 €
B040BARRA20	20	1000	zincata	10	8,19 €
B040BARRA22	22	1000	zincata	5	9,91 €
B040BARRA24	24	1000	zincata	5	11,55 €
B040BARRA27	27	1000	zincata	5	16,80 €
B040BARRA30	30	1000	zincata	5	20,50 €

## DADO AD ALETTE DIN315-UNI5448

Filettatura metrica ISO passo grosso.  
Classe 8.8.



Cod.	Ø mm	Descrizione	Conf.	Prezzo %
B030544804	4	zincata	100	9,24 €
B030544805	5	zincata	100	11,95 €
B030544806	6	zincata	100	13,50 €
B030544808	8	zincata	100	19,25 €
B030544810	10	zincata	100	27,55 €
B030544812	12	zincata	50	24,60 €

## ESAGONO DI GIUNZIONE PER BARRA FILETTATA



Cod.	Filetto	mm	Conf.	Prezzo
B030633405	M5	8x20	100	31,20 €
B030633406	M6	10x30	100	33,70 €
B030633408	M8	13x30	100	41,60 €
B030633410	M10	17x30	100	41,60 €
B030633412	M12	19x30	50	38,20 €
B030633414	M14	19x30	40	47,70 €
B030633416	M16	24x40	30	48,40 €

## VITE ACCIAIO TE INOX-A2 DIN933-UNI5739

Filettatura metrica ISO a passo grosso.  
Gambo interamente filettato.



Cod.	Ø mm	L mm	Conf.	Prezzo %
061600	5	16	100	6,37 €
061601	5	20	100	7,36 €
061602	5	25	100	7,10 €
061603	5	30	100	8,10 €
061604	5	40	100	12,10 €
061605	5	50	100	14,65 €
061606	6	16	100	6,76 €
061607	6	20	100	7,53 €
061609	6	30	100	11,90 €
061610	6	40	100	12,05 €
061611	6	50	100	14,40 €
061612	6	60	100	16,55 €
061614	6	80	100	21,85 €





Cod.	Ø mm	L mm	Conf.	Prezzo %
061617	8	16	100	13,30 €
061618	8	20	100	14,45 €
061619	8	25	100	16,25 €
061620	8	30	100	18,05 €
061621	8	40	100	26,50 €
061622	8	50	100	31,00 €
061623	8	60	100	34,00 €
061625	8	80	100	44,90 €
061626	8	100	100	44,40 €

061627	10	20	100	29,75 €
061628	10	25	100	28,80 €
061629	10	30	100	31,20 €
061630	10	40	100	37,20 €
061631	10	50	100	43,20 €
061632	10	60	100	59,60 €
061633	10	70	100	55,30 €
061634	10	80	100	61,20 €
061635	10	100	100	88,70 €
061636	10	120	100	86,70 €

061637	12	25	100	41,50 €
061638	12	30	100	54,40 €
061639	12	40	100	53,60 €
061640	12	50	100	62,00 €
061641	12	60	100	69,50 €
061642	12	70	100	91,50 €
061643	12	80	100	87,80 €
061644	12	100	100	105,00 €
061645	12	120	100	126,00 €
061646	12	140	100	146,00 €

## BARRA FILETTATA INOX DIN976-A2

Filettatura metrica ISO passo grosso.



Cod.	Ø mm	L mm	Conf.	Prezzo
061497	4	1000	50	1,87 €
061498	5	1000	50	2,30 €
061499	6	1000	50	2,27 €
061500	8	1000	50	4,67 €
061501	10	1000	25	6,01 €
061502	12	1000	20	10,65 €
061503	14	1000	10	14,50 €
061504	16	1000	10	19,50 €
061505	18	1000	10	21,15 €
061506	20	1000	5	25,00 €

## RONDELLA PIANA INOX DIN125/A-A2



Cod.	Ø mm	Conf.	Prezzo %
061486	3	1000	5,10 €
061487	4	1000	5,70 €
061488	5	1000	7,50 €
061489	6	1000	16,20 €
061490	8	1000	24,60 €
061491	10	500	22,65 €
061492	12	200	21,00 €
061493	14	200	22,95 €
061494	16	200	26,60 €
061495	18	200	36,20 €
061496	20	200	39,50 €

## RONDELLA GREMBIALINA INOX DIN9021-A2



Cod.	Ø mm	Conf.	Prezzo %
061507	4x12	1000	11,40 €
061508	5x15	1000	16,20 €
061509	6x18	1000	34,80 €
061510	8x24	500	49,40 €
061511	10x30	200	39,10 €
061512	12x37	200	62,00 €
061513	5x20	500	18,75 €
061514	6x24	500	35,60 €
061515	8x32	300	39,40 €
061516	10x40	200	59,00 €

## DADO ESAGONALE MEDIO INOX DIN934-A2

Filettatura metrica ISO passo grosso.



Cod.	Ø mm	Conf.	Prezzo %
061468	4	1000	15,00 €
061469	5	1000	18,90 €
061470	6	1000	31,50 €
061471	8	500	39,80 €
061472	10	200	29,40 €
061473	12	200	52,20 €
061474	14	100	33,20 €
061475	16	100	43,00 €
061476	18	50	31,90 €
061477	20	50	47,30 €

## DADO AUTOBLOCCANTE INOX DIN985-A2

Filettatura metrica ISO passo grosso.



Cod.	Ø mm	Conf.	Prezzo %
061460	4	1000	27,30 €
061461	5	1000	28,80 €
061462	6	1000	66,60 €
061463	8	500	61,40 €
061464	10	200	33,60 €
061465	12	200	50,50 €
061466	14	100	45,40 €
061467	16	100	52,50 €

## DADO CIECO INOX DIN1587-A2

Filettatura metrica ISO passo grosso.



Cod.	Ø mm	Conf.	Prezzo %
061478	3	1000	68,70 €
061479	4	1000	56,70 €
061480	5	1000	53,70 €
061481	6	500	43,50 €
061482	8	200	29,55 €
061483	10	100	31,50 €
061484	12	100	47,40 €
061485	14	100	103,50 €

## TASSELLO IN NYLON



Tassello universale con 6 alette, corpo a struttura rinforzata e stabilizzatori ai lati.



Cod.	mm	Pz	Conf.	Prezzo
FU-33700	4	200	30	3,12 €
FU-33701	5	200	30	2,92 €
FU-33702	6	200	30	3,22 €
FU-33703	8	100	30	2,74 €
FU-33704	10	50	30	2,55 €
FU-33705	12	25	30	2,77 €

## TASSELLO IN NYLON CON VITE



Tassello universale con 6 alette, corpo a struttura rinforzata e stabilizzatori ai lati. Vite a testa svasata con impronta croce pozidrive.



Cod.	mm	Pz	Conf.	Prezzo
FU-33710	5	200	30	8,02 €
FU-33711	6	100	30	4,39 €
FU-33712	8	100	30	8,40 €
FU-33713	10	50	24	6,94 €

## TASSELLO IN NYLON A 4 SETTORI



Tassello a 4 settori, grazie alla sua elasticità e alla sua versatilità è adattabile ad ogni materiale.



Cod.	mm	Pz	Conf.	Prezzo
FU-33726	5	200	50	7,60 €
FU-33727	6	200	50	6,33 €
FU-33728	8	100	50	6,43 €
FU-33729	10	50	50	6,17 €

## TASSELLO IN NYLON A 4 SETTORI CON VITE



Tassello a 4 settori, grazie alla sua elasticità e alla sua versatilità è adattabile ad ogni materiale. Vite autofilettante in acciaio, con impronta croce pozidrive zincato.



Cod.	mm	Pz	Conf.	Prezzo
FU-33730	5	200	30	10,80 €
FU-33731	6	100	30	4,93 €
FU-33732	8	100	30	8,40 €
FU-33733	10	50	30	9,13 €

## BOX TASSELLO UNIVERSALE NYLON CON VITE + PUNTA



Tassello a 4 settori, grazie alla sua elasticità e alla sua versatilità è adattabile ad ogni materiale. Vite autofilettante in acciaio, con impronta croce pozidriv zincato. In dotazione punta per edilizia.



Cod.	mm	Pz	Conf.	Prezzo
FU-33740	6	300	12	14,25 €
FU-33741	8	150	12	13,50 €

## VALIGETTA 120 TASSELLI 4 SETTORI



Contiene: 50 tasselli F4 5 mm + viti, 40 tasselli F4 6 mm + viti, 20 tasselli F4 8 mm + viti, 10 tasselli F4 10 mm + viti.



Cod.	Materiale	Pz	Conf.	Prezzo
FU-33890	nylon	100	1	15,20 €

## TASSELLO IN NYLON CON VITE



Con tassello antirotazione, vite e rondella.



Cod.	Ø mm	Pz	Conf.	Prezzo
FU-33840	9x40	100	6	21,60 €
FU-33850	12x45	100	6	26,60 €
FU-33857	12x53	100	6	39,80 €

## TASSELLO IN NYLON CON GANCIO CORTO



Con tassello antirotazione, gancio corto e rondella.



Cod.	Ø mm	Pz	Conf.	Prezzo
FU-33841	9x40	100	6	21,60 €
FU-33851	12x43	100	6	26,60 €

## TASSELLO IN NYLON CON GANCIO MEDIO



Con tassello antirotazione, gancio medio e rondella.



Cod.	Ø mm	Pz	Conf.	Prezzo
FU-33842	9x40	100	6	22,10 €
FU-33852	12x43	100	6	27,90 €

## TASSELLO IN NYLON CON GANCIO LUNGO



Con tassello antirotazione, gancio lungo e rondella.



Cod.	Ø mm	Pz	Conf.	Prezzo
FU-33843	9x40	100	6	22,90 €
FU-33853	12x43	100	6	28,80 €

## TASSELLO IN NYLON CON OCCHIOLO APERTO



Con alette antirotazione, occhio aperto e rondella.



Cod.	Ø mm	Pz	Conf.	Prezzo
FU-33844	9x40	100	6	25,95 €
FU-33854	12x43	100	6	31,40 €

## TASSELLO IN NYLON CON OCCHIOLO CHIUSO



Con alette antirotazione, occhiello chiuso e rondella.



Cod.	Ø mm	Pz	Conf.	Prezzo
FU-33845	9x40	100	6	26,00 €
FU-33855	12x43	100	6	31,40 €

## TASSELLO ACCIAIO CON OCCHIOLO CHIUSO



In acciaio.



Cod.	mm	Pz	Conf.	Prezzo
FU-33908	9x45-M5	100	6	26,30 €

## TASSELLO IN NYLON CON DOPPIO DADO



Con vite doppia e rondella metallo. Fissaggi leggeri. Applicazioni: calcestruzzo, cemento, mattone forato-pieno, pietra, laterizi.



Cod.	Ø mm	Pz	Conf.	Prezzo
FU-33846	9x40	50	6	16,45 €
FU-33856	12x43	75	6	32,40 €

## TASSELLO ACCIAIO CON DOPPIO DADO



Tassello con alette antirotazione e pitoneria premontata per fissaggi leggeri universali. Utilizzabile sui principali materiali edili, compatti e mattoni pieni.



Cod.	mm	Pz	Conf.	Prezzo
FU-33911	9x45	100	6	34,40 €

## TASSELLO IN NYLON CON PARACOLPO



Cod.	Ø mm	Colore	Pz	Conf.	Prezzo
FU-33847	9x40	bianco	50	6	20,90 €
FU-33848	9x40	nero	50	6	20,90 €

## TASSELLO PROLUNGATO IN NYLON CON VITE



Tassello utilizzabile su pietra naturale, calcestruzzo, mattoni pieni e semipieni. Vite a testa svasata piana, taglio croce pozidriv.



Cod.	Ø mm	Descrizione	Pz	Conf.	Prezzo
FU-33760	6x60	alette 2	100	24	16,05 €
FU-33761	8x60	alette 2	100	12	21,15 €
FU-33762	8x80	alette 6	100	6	24,65 €
FU-33763	8x100	alette 6	100	6	31,40 €
FU-33764	10x80	alette 6	100	6	38,10 €
FU-33765	10x100	alette 6	50	6	22,65 €
FU-33766	10x115	alette 6	50	6	26,75 €
FU-33767	10x135	alette 6	50	6	31,20 €

## TASSELLO IN ACCIAIO CON VITE COMBINATA



In acciaio.



Cod.	mm	Pz	Conf.	Prezzo
FU-33901	9x45	100	12	20,30 €

## TASSELLO IN ACCIAIO CON GANCIO CORTO



In acciaio.



Cod.	mm	Gancio	Pz	Conf.	Prezzo
FU-33903	9x45	corto	100	12	21,55 €
FU-33905	9x45	medio	100	12	24,05 €
FU-33906	9x45	lungo	100	6	24,05 €

## TASSELLO PROLUNGATO IN NYLON CON VITE



Tassello utilizzabile su pietra naturale, calcestruzzo, mattoni pieni e semipieni. Vite a testa esagonale.



Cod.	Ø mm	Pz	Conf.	Prezzo
FU-33780	8x80	100	6	27,55 €
FU-33783	10x100	50	6	25,45 €
FU-33785	10x160	50	6	43,10 €

## TASSELLO ACCIAIO CON OCCHIOLO APERTO



In acciaio.



Cod.	mm	Pz	Conf.	Prezzo
FU-33910	9x45-M5	100	6	26,30 €

## TASSELLO NYLON RAPIDO A PERCUSSIONE BORDO SVASATO CON VITE



Tassello adatto per fissaggi su muratura compatta e semipiena. Vite a chiodo premontata, impronta a croce pozidriv.



Cod.	Ø mm	Pz	Conf.	Prezzo
FU-33790	5x50	100	24	8,05 €
FU-33791	6x60	100	24	10,70 €
FU-33792	8x80	100	6	20,10 €

### TASSELLO IN ACCIAIO



Con filettatura estesa. Per fissaggio su calcestruzzo e pietra. Fascetta in acciaio inox.



Cod.	mm	Conf.	Prezzo
FU-33927	6x60	100	55,30 €
FU-33928	6x100	100	49,80 €
FU-33930	8x75	100	34,10 €
FU-33929	8x90	100	41,10 €
FU-33933	8x115	50	27,15 €
FU-33931	10x90	50	20,90 €
FU-33934	10x120	50	27,65 €
FU-33932	12x110	50	32,40 €
FU-33935	12x140	25	24,20 €
FU-33936	12x180	25	44,90 €
FU-33937	16x145	20	39,70 €

### TASSELLO IN ACCIAIO



Adatto per calcestruzzo, mattoni pieni, pietre e materiali compatti.



Cod.	Ø foro mm	mm	Conf.	Prezzo
FU-33954	12	6x45	100	61,60 €
FU-33955	14	8x50	50	41,80 €
FU-33956	16	10x60	50	62,50 €

### TASSELLO IN ACCIAIO CON VITE



Con alette laterali antirotazione. Adatto per calcestruzzo, mattoni pieni, pietre ecc.



Cod.	Misura	Conf.	Prezzo
FU-33950	M6	100	82,40 €
FU-33951	M8	50	50,50 €
FU-33952	M10	50	72,00 €
FU-33953	M12	25	55,60 €

### TASSELLO IN ACCIAIO CON OCCHIOLO APERTO



Con alette laterali antirotazione. Adatto per calcestruzzo, mattoni pieni, pietre, ecc.



Cod.	Misura	Conf.	Prezzo
FU-33946	M6	100	141,50 €
FU-33947	M8	50	90,50 €
FU-33948	M10	50	129,50 €

### TASSELLO IN ACCIAIO CON OCCHIOLO CHIUSO



Con alette laterali antirotazione. Adatto per calcestruzzo, mattoni pieni, pietre, ecc.



Cod.	Misura	Conf.	Prezzo
FU-33957	M6	100	133,50 €
FU-33958	M8	50	89,90 €
FU-33959	M10	50	127,50 €

### TASSELLO ACCIAIO ANTIROTAZIONE



Ancorante in lamiera stampata per fissaggi medi e medio-pesanti. Utilizzabile su materiali compatti quali pietra naturale e calcestruzzo.



Cod.	Misura	Conf.	Prezzo
FU-33938	M6	100	42,80 €
FU-33939	M8	50	48,00 €
FU-33940	M10	50	73,70 €

### TASSELLO ACCIAIO CON VITE TESTA ESAGONALE 8.8



Ancorante in lamiera stampata per fissaggi medi e medio-pesanti. Utilizzabile su materiali compatti quali pietra naturale e calcestruzzo.



Cod.	mm	Conf.	Prezzo
FU-33942	6x50	100	76,20 €
FU-33943	8x60	50	51,10 €
FU-33944	10x80	50	41,40 €

### TASSELLO NYLON 4 SETTORI CON VITE



In secchiello.



Cod.	mm	Pz	Conf.	Prezzo
FU-33746	8	50	1	6,30 €

### TASSELLO ACCIAIO MINI CON VITE



In acciaio.



Cod.	Misura	mm	Conf.	Prezzo
024001	M3	6	200	0,26 €

### TASSELLO ACCIAIO GANCIO CORTO



In acciaio.



Cod.	Misura	mm	Conf.	Prezzo
024002	M3	6	200	0,28 €

### TASSELLO ACCIAIO MINI OCCHIO CHIUSO



In acciaio.



Cod.	Misura	mm	Conf.	Prezzo
024003	M3	6	200	0,35 €

## TASSELLO NYLON X1 EVO CON BORDO



Tassello a 4 settori. Adatto per coperture metalliche, impiantistica elettrica, impiantistica idraulica, recupero edilizio, serramenti e sistemi a secco/cartongesso.



Cod.	mm	Pz	Conf.	Prezzo
041408	5x25	100	1	4,21 €
041409	6x30	100	1	4,55 €
041410	8x40	100	1	7,01 €
041411	10x50	100	1	5,98 €
041412	12x60	100	1	6,51 €
041413	14x70	100	1	11,00 €

## TASSELLO NYLON X1 EVO CON BORDO E VITE TPS



Tassello a 4 settori. Adatto per coperture metalliche, impiantistica elettrica, impiantistica idraulica, recupero edilizio, serramenti e sistemi a secco/cartongesso.



Cod.	mm	Pz	Conf.	Prezzo
041404	5x25	100	1	11,60 €
041405	6x30	100	1	12,60 €
041406	8x40	50	1	9,31 €
041407	10x50	25	1	11,25 €

## TASSELLO NYLON X1 EVOL CON BORDO E VITE TPS



Tassello a 4 settori. Lunghezza maggiorata. Adatto per coperture metalliche, impiantistica elettrica, impiantistica idraulica, recupero edilizio, serramenti e sistemi a secco/cartongesso.



Cod.	mm	Pz	Conf.	Prezzo
053153	6x50	100	1	18,50 €
053154	8x60	50	1	14,20 €
053155	10x70	25	1	14,90 €

## TASSELLO IN NYLON SX



Tassello ad espansione in nylon. Esclusiva espansione a 4 settori. Utilizzabile con viti legno, trucioli o autofilettanti. L'espansione a 4 settori garantisce elevati valori di tenuta. Le speciali alette antirotazione impediscono al tassello di ruotare all'interno del foro.



Cod.	Sx	lt	Pz	Conf.	Prezzo
FI70005	5	25	100	40	6,07 €
FI70006	6	30	100	40	6,69 €
FI70008	8	40	100	40	10,30 €
FI70010	10	50	50	40	8,81 €
FI70012	12	60	25	40	8,12 €
FI70014	14	70	20	24	13,95 €

## TASSELLO IN NYLON SX-S



Tassello ad espansione in nylon. Esclusiva espansione a 4 settori. Utilizzabile con viti legno, trucioli o autofilettanti. L'espansione a 4 settori garantisce elevati valori di tenuta. Le speciali alette antirotazione impediscono al tassello di ruotare all'interno del foro.



Cod.	Sx-S	lt	Pz	Conf.	Prezzo
FI70020	5	25	100	40	15,50 €
FI70021	6	30	100	40	16,55 €
FI70022	8	40	50	40	12,25 €
FI70025	10	50	25	24	14,70 €

## TASSELLO IN NYLON S



Tassello ad espansione in nylon. Utilizzabile con viti legno, trucioli o autofilettanti. Le alette antirotazione impediscono al tassello di ruotare all'interno del foro. La qualità del nylon garantisce anni di sicurezza ed affidabilità. Resistente alle temperature da -40°C a +80°C. L'apertura longitudinale consente un'efficace espansione.



Cod.	S	lt	Pz	Conf.	Prezzo
FI00131	4	20	100	20	5,26 €
FI00132	5	25	100	40	5,77 €
FI00133	6	30	100	40	6,12 €
FI00134	7	30	100	40	9,39 €
FI00135	8	40	100	40	9,39 €
FI00136	10	50	50	40	8,00 €
FI00137	12	60	25	40	7,50 €
FI00138	14	75	20	24	13,00 €

## TASSELLO IN NYLON SV



Tassello ad espansione in nylon. Utilizzabile con viti legno, trucioli o autofilettanti. Le alette antirotazione impediscono al tassello di ruotare all'interno del foro. La qualità del nylon garantisce anni di sicurezza ed affidabilità. Resistente alle temperature da -40°C a +80°C. L'apertura longitudinale consente un'efficace espansione.

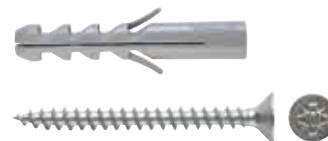

Cod.	SV	lt	Pz	Conf.	Prezzo
FI00261	5	25	100	40	14,65 €
FI00262	6	30	100	40	15,65 €
FI00264	8	40	50	40	11,25 €
FI00265	10	50	25	24	14,00 €

## TASSELLO BI-MATERIAL DUOPOWER



Tassello a due materiali che si espande, si piega e si annoda in maniera intelligente perchè riconosce il tipo di muratura.



Cod.	Ø x prof. foro mm	Pz	Conf.	Prezzo
FI537646	6x45	100	1	18,70 €
FI537647	8x65	50	1	13,85 €
FI537648	10x70	25	1	16,65 €

## TASSELLO BI-MATERIAL DUOPOWER



Tassello universale bi-materiale ideale per il fissaggio di carichi medi e leggeri su muratura, calcestruzzo e cartongesso



Cod.	Ø x prof. foro mm	Pz	Conf.	Prezzo
FI537639	5x25	100	1	6,74 €
FI537640	6x30	100	1	7,44 €
FI537641	8x40	100	1	11,45 €
FI537644	10x50	100	1	9,78 €

## TASSELLO IN NYLON RINFORZATO CON VITE DUOTEC



Il fissaggio DUOTEC è idoneo per installazione non passante. L'elemento basculante del fissaggio ruota automaticamente dietro il pannello garantendone il corretto posizionamento.



Cod.	Ø foro mm	Pz	Conf.	Prezzo
FI540179	10	25	1	25,55 €

## TASSELLO IN NYLON FU



Tassello universale in nylon. La particolare espansione del tassello fu permette fissaggi su qualsiasi tipo di materiale.



Cod.	FU	Pz	Conf.	Prezzo
FI02345	6x35	100	24	18,25 €
FI02346	6x45	100	24	19,20 €
FI02348	8x50	100	24	23,65 €
FI02350	10x60	50	12	18,45 €

## TASSELLO IN NYLON FU-V



Tassello universale in nylon. La particolare espansione del tassello fu permette fissaggi su qualsiasi tipo di materiale.



Cod.	FU-V	Vite Ø mm	Pz	Conf.	Prezzo
FI02351	6x35	3,5x45	100	24	28,45 €
FI02352	6x45	3,5x55	100	24	32,60 €
FI02353	8x50	4,5x60	50	24	19,35 €
FI02354	10x60	6x80	25	24	16,05 €

## TASSELLO IN NYLON SB 9/1



Per fissaggi leggeri. Il particolare profilo del tassello consente un'efficace espansione.



Cod.	Pz	Conf.	Prezzo
FI00341	100	5	31,90 €

## TASSELLO IN NYLON SB 9/2



Per fissaggi leggeri. Il particolare profilo del tassello consente un'efficace espansione.



Cod.	Pz	Conf.	Prezzo
FI00342	100	5	28,20 €

## TASSELLO IN NYLON SB 9/3



Per fissaggi leggeri. Il particolare profilo del tassello consente un'efficace espansione.



Cod.	Pz	Conf.	Prezzo
FI00343	100	5	31,60 €

## TASSELLO IN NYLON SB 9/4



Per fissaggi leggeri. Il particolare profilo del tassello consente un'efficace espansione.



Cod.	Pz	Conf.	Prezzo
FI00344	100	10	25,70 €

## TASSELLO IN NYLON SB 9/5 M4X35



Per fissaggi leggeri. Il particolare profilo del tassello consente un'efficace espansione.



Cod.	Pz	Conf.	Prezzo
FI00345	50	10	21,20 €

## TASSELLO IN NYLON SB 9/8



Per fissaggi leggeri. Il particolare profilo del tassello consente un'efficace espansione.



Cod.	Pz	Conf.	Prezzo
FI00348	100	10	25,70 €

## TASSELLO IN NYLON CON PARACOLPO NERO SB 9/11



Per fissaggi leggeri. Il particolare profilo del tassello consente un'efficace espansione.



Cod.	Pz	Conf.	Prezzo
<b>FI00351</b>	50	5	34,60 €

## TASSELLO IN NYLON SB 12/4



Per fissaggi leggeri. Il particolare profilo del tassello consente un'efficace espansione.



Cod.	Pz	Conf.	Prezzo
<b>FI00364</b>	100	5	36,60 €

## TASSELLO IN NYLON CON PARACOLPO BIANCO SB 9/12



Per fissaggi leggeri. Il particolare profilo del tassello consente un'efficace espansione.



Cod.	Pz	Conf.	Prezzo
<b>FI00352</b>	50	5	34,60 €

## TASSELLO IN NYLON SB 12/8



Per fissaggi leggeri. Il particolare profilo del tassello consente un'efficace espansione.



Cod.	Pz	Conf.	Prezzo
<b>FI00368</b>	100	5	33,30 €

## TASSELLO IN NYLON SB 12/1



Per fissaggi leggeri. Il particolare profilo del tassello consente un'efficace espansione.



Cod.	Pz	Conf.	Prezzo
<b>FI00361</b>	50	5	23,40 €

## TASSELLO IN NYLON SB 12/10



Per fissaggi leggeri. Il particolare profilo del tassello consente un'efficace espansione.



Cod.	Pz	Conf.	Prezzo
<b>FI00370</b>	25	10	25,25 €

## TASSELLO IN NYLON SB 12/2



Per fissaggi leggeri. Il particolare profilo del tassello consente un'efficace espansione.



Cod.	Pz	Conf.	Prezzo
<b>FI00362</b>	100	5	37,40 €

## TASSELLO PROLUNGATO IN NYLON SB 12 L 4



Per fissaggi leggeri. Il particolare profilo del tassello consente un'efficace espansione.



Cod.	Pz	Conf.	Prezzo
<b>FI00374</b>	50	10	25,10 €

## TASSELLO IN NYLON SB 12/3



Per fissaggi leggeri. Il particolare profilo del tassello consente un'efficace espansione.



Cod.	Pz	Conf.	Prezzo
<b>FI00363</b>	50	5	22,55 €

## TASSELLO PROLUNGATO IN NYLON SB 12 L 8



Per fissaggi leggeri. Il particolare profilo del tassello consente un'efficace espansione.



Cod.	Pz	Conf.	Prezzo
<b>FI00378</b>	50	10	25,10 €

## TASSELLO IN ACCIAIO SBS



Per fissaggi leggeri.  
Le schermature del tassello in acciaio zincocromato consentono un'efficace espansione.



Cod.	Tipo	Descrizione	Pz	Conf.	Prezzo
FI00401	8/1	-	50	5	20,85 €
FI00411	9/1	con occhio	50	5	26,10 €

## TASSELLO IN ACCIAIO SBS



Per fissaggi leggeri.  
Le schermature del tassello in acciaio zincocromato consentono un'efficace espansione.



Cod.	Tipo	Descrizione	Pz	Conf.	Prezzo
FI00402	8/2	-	100	5	37,70 €
FI00412	9/2	con gancio	100	5	40,90 €

## TASSELLO IN ACCIAIO SBS



Per fissaggi leggeri.  
Le schermature del tassello in acciaio zincocromato consentono un'efficace espansione.



Cod.	Tipo	Descrizione	Pz	Conf.	Prezzo
FI00403	8/3	-	50	5	20,65 €
FI00413	9/3	con occhio	50	5	26,10 €

## TASSELLO IN ACCIAIO SBS



Per fissaggi leggeri.  
Le schermature del tassello in acciaio zincocromato consentono un'efficace espansione.



Cod.	Tipo	Descrizione	Pz	Conf.	Prezzo
FI00404	8/4	-	100	5	37,40 €
FI00414	9/4	con vite	100	5	40,10 €

## TASSELLO IN ACCIAIO SBS 9/5



Per fissaggi leggeri.  
Le schermature del tassello in acciaio zincocromato consentono un'efficace espansione. Ø vite M5x40.



Cod.	Pz	Conf.	Prezzo
FI00415	50	5	31,50 €

## TASSELLO IN ACCIAIO SBS



Per fissaggi leggeri.  
Le schermature del tassello in acciaio zincocromato consentono un'efficace espansione. Ø vite M5x40.



Cod.	Tipo	Descrizione	Pz	Conf.	Prezzo
FI00408	8/8	-	100	5	37,40 €
FI00418	9/8	con gancio	100	5	40,10 €

## TASSELLO IN NYLON FUR-T PROLUNGATO



Tassello prolungato universale in nylon. Ideale nel fissaggio di profili per serramenti siametallici che di legno. Adatto per tutti i materiali edili grazie alla innovativa tecnica di espansione.



Cod.	mm	Spes. est	Pz	Conf.	Prezzo
FI02081	8x80	10	50	10	52,30 €
FI02082	8x100	30	50	10	57,80 €
FI02083	8x120	50	50	5	65,50 €
FI01881	10x80	10	50	5	58,60 €
FI01882	10x100	30	50	5	64,10 €
FI01888	10x115	45	50	5	68,10 €
FI01883	10x135	65	50	5	72,50 €
FI01884	10x160	90	50	1	111,00 €
FI01885	10x185	115	50	1	186,00 €
FI01886	10x200	130	50	1	199,00 €

## TASSELLO IN NYLON N PROLUNGATO



Per fissaggi leggeri. Con bordo svasato e vite a chiodo premontata.



Cod.	mm	Spes. est	Pz	Conf.	Prezzo
FI02702	4x35	10	100	12	9,24 €
FI01971	5x50	25	100	10	16,50 €
FI48788	6x40	10	100	10	20,20 €
FI01972	6x60	30	100	10	21,50 €
FI01974	6x80	50	100	5	23,50 €
FI01978	8x60	20	100	5	26,80 €
FI01973	8x80	40	50	5	14,65 €
FI01975	8x100	60	50	5	20,45 €
FI01976	8x120	80	50	5	27,00 €
FI01979	10x100	50	50	5	34,60 €
FI01980	10x135	85	50	5	41,40 €
FI01981	10x160	110	50	5	56,30 €

## TASSELLO IN NYLON CON VITE SXRL FUS



Con vite premontata T.E. flangiata impronta Torx.



Cod.	mm	Pz	Conf.	Prezzo
FI522719	10x80	50	1	47,30 €
FI522720	10x100	50	1	51,70 €
FI522721	10x120	50	1	56,30 €
FI522724	10x160	50	1	72,20 €
FI522726	10x200	50	1	126,00 €
FI522728	10x260	50	1	210,00 €



## TASSELLO IN NYLON CON VITE SXRL WTIS



Con vite in acciaio zincato a testa svasata piana ed impronta Torx.



Cod.	mm	Pz	Conf.	Prezzo
FI540207	8x60	50	1	21,45 €
FI540208	8x80	50	1	25,30 €
FI540209	8x100	50	1	33,10 €
FI540210	8x120	50	1	39,60 €
FI543462	10x80	50	1	42,60 €
FI543463	10x100	50	1	46,80 €
FI543464	10x120	50	1	51,40 €

## SISTEMA DI FISSAGGIO ISOLATO FID



Installazione rapida e semplice. Non occorre perforare prima strati di intonaco sottili. Grazie alla sua versatilità, è idoneo per molte applicazioni diverse tra cui sistemi ETICS. È utilizzabile con viti per truciolare standard.



Cod.	L mm	Pz	Conf.	Prezzo
FI48213	50	50	1	0,81 €
FI510971	90	25	1	1,17 €

## TASSELLO PER CARTONGESSO GK



Per fissaggi leggeri. Con vite a chiodo bronzata. Ogni confezione contiene un inserto GKW per l'avvitamento.



Cod.	Descrizione	Pz	Conf.	Prezzo
FI52389	con vite a chiodo	100	25	26,20 €

## TASSELLO IN METALLO PER CARTONGESSO GKM



Tassello autoflettante in metallo per applicazioni su pannelli e lastre in cartongesso. Applicazioni per quadri, luci, impianti elettrici, fissaggio accessori.



Cod.	mm	Pz	Conf.	Prezzo
FI24556	31	100	1	41,10 €

## TASSELLO IN ACCIAIO ZINCATO FAZ II



Ancorante per installazione passante con le migliori performance della sua categoria, per calcestruzzo fessurato. Si distingue per la caratteristica fascetta di espansione nera. Ancorante con Benestare Tecnico Europeo Opzione 1.



Cod.	Varie	lt	S	Conf.	Prezzo
FI94871	FAZ II 8/10	77	10	50	1,16 €
FI94981	FAZ II 10/10	95	10	50	1,63 €
FI95419	FAZ II 12/10	110	10	20	2,23 €

## TASSELLO IN ACCIAIO CON DISTANZIALE TAM 8-BP



Ancorante passante per fissaggi in calcestruzzo non fessurato.



Cod.	mm	Ø foro	Conf.	Prezzo
FI90265	84	12 mm	50	4,09 €

## TASSELLO IN ACCIAIO ZINCATO FBN II



Ancorante in acciaio con zincatura bianca dotato di fascetta di espansione, dado e rosetta. L'ancorante FBN II è marcato Ce, avendo ottenuto il Benestare Tecnico europeo, opzione 7 per calcestruzzo non fessurato. Inserimento rapido nel foro con pochi colpi di martello. Veloce raggiungimento della coppia di serraggio con pochi giri del dado esagonale.



Cod.	Ø x spes. max mm	Ancorante mm	Conf.	Prezzo
FI45130	6x5	50	100	0,61 €
FI45136	6x10	55	100	0,63 €
FI45137	6x30	75	100	0,76 €

FI40662	8x5	66	50	0,75 €
FI40664	8x10	71	50	0,76 €
FI40700	8x30	91	50	0,92 €
FI40771	8x50	111	50	0,96 €
FI40783	8x100	161	20	1,78 €

FI40827	10x10	86	50	1,07 €
FI40851	10x20	96	50	1,14 €
FI40854	10x30	106	50	1,25 €
FI40855	10x50	126	20	1,27 €
FI40931	10x70	146	20	2,06 €
FI40943	10x100	176	20	2,45 €
FI40944	10x140	216	20	3,48 €
FI40945	10x160	236	20	3,75 €

FI40950	12x10	106	20	1,62 €
FI44558	12x20	116	20	1,78 €
FI45264	12x50	146	20	2,06 €
FI45265	12x80	176	20	3,37 €
FI45266	12x100	196	20	4,37 €

FI45564	16x25	145	10	3,02 €
FI45565	16x50	170	10	4,52 €
FI45566	16x80	200	10	6,06 €
FI45567	16x100	220	10	7,14 €

## TASSELLO IN ACCIAIO CON VITE FSL



Ancorante per installazione passante per fissaggi non strutturali in calcestruzzo in zona compressa. Vite testa esagonale (classe 8.8) e rondella maggiorata.



Cod.	mm	Pz	Conf.	Prezzo
FI523923	8x60/15 S	50	250	0,60 €
FI523924	8x80/35 S	50	250	0,69 €
FI523926	10x65/10 S	25	125	0,84 €
FI523927	10x85/30 S	25	125	0,95 €
FI523929	12x80/10 S	20	100	1,32 €



# DUOPOWER

## Forza e intelligenza in perfetto equilibrio

Tre diverse funzioni:

si espande, si piega, si annoda in maniera intelligente.

Riconosce il tipo di muratura e si adatta automaticamente.

**DUOBLADE**  
Il tassello autoforante  
per installazioni facili e veloci  
su pannelli e lastre di cartongesso.



**fischer DUOTEC**  
Il fissaggio ad ancora  
per applicazioni su tutte le lastre.



## TASSELLO IN OTTONE PO



Adatto per calcestruzzo, legno di abete, faggio, essenze dure, materiali compatti. Per fissare controsoffitti, pendinature, mensole e profilati.



Cod.	Varie	lt	Ø foro	Conf.	Prezzo
FI01441	PO M 5	22	7	200	0,38 €
FI01442	PO M 5	24	8	100	0,48 €
FI01445	PO M 8	30	10	100	0,59 €
FI01448	PO M 10	35	12	100	0,96 €
FI01449	PO M 12	40	15	100	1,80 €

## COLLARE PESANTE IN ACCIAIO ZINCATO PER TUBAZIONI CPT



Collare in acciaio zincato per tubi da 3/8" a 2 1/12". Completo di vite M8 e tassello Ø 10 mm. Il sistema di chiusura brevettato consente una rapida installazione del tubo senza togliere precedentemente le viti di serraggio (per diametri da 3/8" a 2").

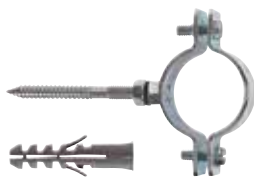

Cod.	Varie	Conf.	Prezzo
FI01130	CPT 3/8"	1	1,26 €
FI01131	CPT 1/2"	1	1,23 €
FI01132	CPT 3/4"	1	1,23 €
FI01133	CPT 1"	1	1,26 €
FI01134	CPT 1 1/4"	1	1,45 €
FI01135	CPT 1 1/2"	1	1,57 €
FI01136	CPT 2"	1	1,71 €
FI01137	CPT 2 1/2"	1	3,28 €

## COLLARE PER PLUVIALE SCP



collare in acciaio con vite M8 e tassello Ø 10 m. Per fissaggio dei tubi pluviali.



Cod.	Ø x L mm	Colore	Conf.	Prezzo
FI501301	80x50	zincato	50	1,83 €
FI501302	100x50	zincato	50	1,98 €
FI501303	120x50	zincato	50	2,21 €
FI501316	100x50	marrone	50	2,64 €

## FISSAGGIO WB 2 INOX



Fissaggio per water e bidet a pavimento con fori verticali. Vite in acciaio inox AISI 430.



Cod.	Ø punta mm	Pz	Conf.	Prezzo
FI501004	8	50	200	3,45 €

## TASSELLO IN ACCIAIO PER PONTEGGI



Ancorante in acciaio per ponteggi con occhio Ø 23 e foto Ø 12.



Cod.	Descrizione	Conf.	Prezzo
FI500572	FA 12 G x 120	20	21,90 €

## GOLFARE IN ACCIAIO FORGIATO TAM 12 CORTO



Per ponteggi con stelo esagonale e tassello TAM 12.



Cod.	Ø foro	Conf.	Prezzo
FI08088	18 mm	20	12,50 €

## RICAMBIO PER GOLFARE TAM 12



Cod.	Descrizione	Conf.	Prezzo
FI508753	TAM 12	20	2,44 €

## TASSELLO IN ACCIAIO SLM



Adatto per calcestruzzo, mattoni pieni, pietre e materiali compatti. Ancorante in acciaio zinco-cromato, costituito da due elementi semicirculari completi di cono espansore e accessorio.



Cod.	Varie	lt	Ø foro	Conf.	Prezzo
FI00601	SLM 6	45	12	50	1,37 €
FI00602	SLM 8	50	14	50	1,84 €
FI00603	SLM 10	60	16	25	2,90 €
FI00604	SLM 12	75	20	20	4,36 €

## TASSELLO IN ACCIAIO SLM CON VITE T.E. CLASSE 8.8



Adatto per calcestruzzo, mattoni pieni, pietre e materiali compatti. Ancorante in acciaio zinco-cromato, costituito da due elementi semicirculari completi di cono espansore e accessorio.



Cod.	Varie	lt	Ø foro	Conf.	Prezzo
FI00621	SLM 6	12	M6x50	50	1,83 €
FI00622	SLM 8	14	M8x60	50	2,28 €
FI00623	SLM 10	16	M10x80	25	3,94 €
FI00624	SLM 12	20	M12x90	20	5,83 €

## TASSELLO IN ACCIAIO SLM CON OCCHIOLO



Adatto per calcestruzzo, mattoni pieni, pietre e materiali compatti. Ancorante in acciaio zinco-cromato, costituito da due elementi semicircolari completi di cono espansore e accessorio.



Cod.	Occhio	Ø foro	Conf.	Prezzo
FI00631	6	12	50	3,37 €
FI00632	8	14	50	4,76 €
FI00633	10	16	25	6,30 €

## TASSELLO IN ACCIAIO SLM CON GANCIO FORGIATO



Adatto per calcestruzzo, mattoni pieni, pietre e materiali compatti. Ancorante in acciaio zinco-cromato, costituito da due elementi semicircolari completi di cono espansore e accessorio.



Cod.	Gancio mm	Ø foro	Conf.	Prezzo
FI00641	6	12	50	3,98 €
FI00642	8	14	50	5,01 €
FI00643	10	16	25	6,90 €

## TASSELLO IN GHISA GM



Adatto per calcestruzzo e roccia. Ancorante composto da un cono espansore e da quattro gusci in ghisa malleabile che garantiscono un perfetto adattamento anche nella roccia. La particolare espansione consente elevati valori di carico.



Cod.	Varie	Ø foro	lt	Conf.	Prezzo
FI00901	GM 6	12	47	50	2,56 €
FI00902	GM 8	15	50	50	2,95 €
FI00903	GM 10	18	60	25	4,52 €
FI00904	GM 12	22	75	20	7,43 €

## TASSELLO IN ACCIAIO TAM



Adatto per calcestruzzo non fessurato, pietra naturale, mattone pieno. Ancorante in acciaio zincocromato con tre settori espandenti. Adatto per carpenteria leggera e pesante. Ideale per calcestruzzo non fessurato. Bugnature di aggrappo per una migliore aderenza nel foro.



Cod.	Varie	Ø foro	P	Conf.	Prezzo
FI90245	TA M 6	10	65	50	1,23 €
FI90246	TA M 8	12	70	50	1,40 €
FI90247	TA M 10	15	90	25	1,87 €
FI90248	TA M 12	18	115	25	2,63 €

## TASSELLO IN ACCIAIO TAM CON VITE TE



Adatto per calcestruzzo non fessurato, pietra naturale, mattone pieno. Ancorante in acciaio zincocromato con tre settori espandenti. Adatto per carpenteria leggera e pesante. Ideale per calcestruzzo non fessurato. Bugnature di aggrappo per una migliore aderenza nel foro.



Cod.	Varie	Ø VxLb	Ø foro	Conf.	Prezzo
FI90249	TA M 6 S/10	M6x60	10	50	1,48 €
FI90250	TA M 8 S/10	M8x65	12	50	1,85 €
FI90251	TA M 10 S/20	M10x90	15	25	2,92 €
FI90252	TA M 12 S/25	M12x110	18	20	4,12 €

## TASSELLO TAM CON OCCHIOLO



Con occhio cl 8.8. Adatto per calcestruzzo non fessurato, pietra naturale, mattone pieno. Ancorante in acciaio zincocromato con tre settori espandenti. Adatto per carpenteria leggera e pesante. Ideale per calcestruzzo non fessurato. Bugnature di aggrappo per una migliore aderenza nel foro.



Cod.	Varie	Ø VxLb	Ø foro	Conf.	Prezzo
FI90257	TA M 6 O	M6x56	10	50	2,20 €
FI90258	TA M 8 O	M8x62	12	50	2,61 €
FI90259	TA M 10 O	M10x77	15	25	3,72 €
FI90260	TA M 12 O	M12x96	18	15	6,06 €

## ANCORA A SOFFITTO IN ACCIAIO KD 4

Per fissaggi materiali elettrici.



Cod.	Descrizione	Conf.	Prezzo
FI01461	KD 4	50	1,05 €

## ANCORA A SOFFITTO IN ACCIAIO KDH 4

Per fissaggi materiali elettrici.



Cod.	Descrizione	Conf.	Prezzo
FI01462	KDH 4	50	0,98 €

## ANCORA A SOFFITTO IN ACCIAIO KDD 4

Per fissaggi materiali elettrici.



Cod.	Descrizione	Conf.	Prezzo
FI01463	KDD 4	50	1,04 €

## ANCORA A SOFFITTO IN ACCIAIO KDO 4

Per fissaggi materiali elettrici.



Cod.	Descrizione	Conf.	Prezzo
FI01468	KDO 4	50	0,98 €

## ANCORA A SOFFITTO IN ACCIAIO KDV 4

Per fissaggi materiali elettrici.

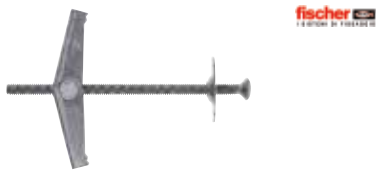

Cod.	Descrizione	Conf.	Prezzo
FI01469	KDV 4	50	0,91 €

## ANCORA A SOFFITTO IN ACCIAIO KD 6-8

Per fissaggi materiali elettrici.



Cod.	Descrizione	Conf.	Prezzo
FI01466	KD 6	25	1,55 €
FI01470	KD 8	20	4,11 €

## ANCORA A SOFFITTO IN ACCIAIO KDH 6-8

Per fissaggi materiali elettrici.



Cod.	Descrizione	Conf.	Prezzo
FI01467	KDH 6	25	1,66 €
FI01471	KDH 8	20	5,33 €

## GAFFETTA PER TUBI IN ACCIAIO

Gaffetta in acciaio zincato. Adatta per tasselli SX 6, S 6 con vite o chiodi ED 18, ED 22, per fissare tubi in acciaio, plastica e multistrato.



Cod.	Ø mm	Pz	Conf.	Prezzo
FI01170	10	50	12	5,43 €
FI01171	13	50	12	5,97 €
FI01172	16	50	12	6,60 €
FI01173	20	50	12	8,43 €
FI01174	22	25	12	4,89 €
FI01175	25	25	12	5,48 €
FI01177	32	20	12	6,05 €
FI01178	40	5	12	3,28 €
FI01179	50	5	12	3,52 €

## BANDELLA PERFORATA LBV

In acciaio zincato.



Cod.	m x mm	Ø foro mm	Conf.	Prezzo
FI79549	10x12	5	10	10,80 €
FI79550	10x17	6,5	10	11,40 €

## BANDELLA IN TESSUTO GWB

In tessuto.



Cod.	mm	Conf.	Prezzo
FI20959	14	10	5,33 €

## CHIEDO A PERCUSSIONE ED



Cod.	Lunghezza	Ø	Conf.	Prezzo
FI79815	18 mm	4 mm	200	18,05 €

## PERCUSSORE PER CHIODI A PERCUSSIONE ED



fischer  
L'esperto in ferramenta

Cod.	Descrizione	Conf.	Prezzo
<b>FI79820</b>	a percussione ED	1	58,90 €

## ANCORANTE CHIMICO

Ancorante chimico universale per muratura piena e forata. Resina poliesteri senza stirene.



TYTAN  
L'esperto in ferramenta

Cod.	Descrizione	ml	Conf.	Prezzo
<b>TY963384</b>	grigio	165	12	8,66 €
<b>TY960109</b>	grigio	300	12	8,53 €
<b>TY960116</b>	grigio	410	12	10,05 €

## MISCELATORE PER ANCORANTE CHIMICO

Beccuccio a miscelatore, per riutilizzo di cartucce di ancoranti chimici, adatto per tutte le cartucce di ancoranti chimici.



TYTAN  
L'esperto in ferramenta

Cod.	Pz	Conf.	Prezzo
<b>TYMISC</b>	12	12	8,15 €

## TASSELLO A CALZA FIS HN

Tassello a calza FIS HN per ancoranti chimici in muratura forata.



fischer  
L'esperto in ferramenta

Cod.	Varie	Ø foro	P	Conf.	Prezzo
<b>FI50470</b>	FIS H 16x85 N (x M8)	16	95	20	1,91 €
<b>FI50472</b>	FIS H 18x85 N (x M10)	18	95	20	2,05 €
<b>FI50474</b>	FIS H 20x85 N (x M12)	20	95	20	2,48 €

## TASSELLO IN RETE AD INIEZIONE FIS HK

Per ancoranti chimici.



fischer  
L'esperto in ferramenta

Cod.	Varie	Conf.	Prezzo
<b>FI41900</b>	FIS H 12x50 K	50	0,52 €
<b>FI41901</b>	FIS H 12x85 K	50	0,58 €
<b>FI41902</b>	FIS H 16x85 K	50	0,61 €
<b>FI41905</b>	FIS H 16x130 K	50	0,84 €
<b>FI41906</b>	FIS H 20x85 K	50	0,74 €

## MENSOLA A SCOMPARSA CSB E CPF



fischer  
L'esperto in ferramenta

Cod.	Descrizione	Larghezza ripiani mm	Conf.	Prezzo
<b>FI01610</b>	CSB 8x70	9-13	50	1,96 €
<b>FI01641</b>	CPF 10x100	12-15	20	2,21 €
<b>FI01644</b>	CPF 10x150	16-20	20	2,30 €
<b>FI01647</b>	CPF 12x80	9-13	20	2,30 €
<b>FI01631</b>	CPF 14x120	13-16	20	2,38 €
<b>FI01632</b>	CPF 14x145	16-20	20	2,46 €
<b>FI01633</b>	CPF 14x170	18-23	20	2,52 €

## MENSOLA NERVATA MN

Conf. da 2 pezzi.



fischer  
L'esperto in ferramenta

Cod.	cm	Ripiani cm	Colore	Conf.	Prezzo
<b>FI01650</b>	7,5x10	8-13	grigio	10	0,87 €
<b>FI01651</b>	10x12,5	10-17	grigio	10	0,97 €
<b>FI01652</b>	12,5x15	13-20	grigio	10	1,15 €
<b>FI01653</b>	15x20	15-26	grigio	10	1,40 €
<b>FI01654</b>	20x25	20-33	grigio	10	1,90 €
<b>FI01655</b>	25x30	25-40	grigio	10	2,70 €
<b>FI01656</b>	30x35	30-46	grigio	10	3,48 €
<b>FI09701</b>	7,5x10	8-13	bianco	10	0,87 €
<b>FI09702</b>	10x12,5	10-17	bianco	10	0,97 €
<b>FI09703</b>	12,5x15	13-20	bianco	10	1,15 €
<b>FI09704</b>	15x20	15-26	bianco	10	1,40 €
<b>FI09705</b>	20x25	20-33	bianco	10	1,90 €
<b>FI09706</b>	25x30	25-40	bianco	10	2,70 €
<b>FI09707</b>	30x35	30-46	bianco	10	3,48 €

## MENSOLA BRACKETS NERA



fischer  
L'esperto in ferramenta

Cod.	cm	Colore	Conf.	Prezzo
<b>2800.150115</b>	15x11,5	nero	1	2,79 €
<b>2800.200150</b>	20x15	nero	1	4,03 €

## MENSOLA ARREDAMENTO



Cod.	cm	Colore	Sc	Prezzo
2900B.12	12	bianco	2	0,78 €
2900N.12	12	nero	2	0,78 €
2900R.12	12	rosso	2	0,78 €
2900F.12	12	frassino	2	0,78 €
2900M.12	12	marrone	2	0,78 €
2900B.18	18	bianco	2	1,28 €
2900N.18	18	nero	2	1,02 €
2900R.18	18	rosso	2	1,02 €
2900F.18	18	frassino	2	1,02 €
2900M.18	18	marrone	2	1,28 €
2900B.24	24	bianco	2	1,63 €
2900N.24	24	nero	2	1,63 €
2900R.24	24	rosso	2	1,30 €
2900F.24	24	frassino	2	1,30 €
2900M.24	24	marrone	2	1,30 €

## MENSOLA ARREDAMENTO NERVATA VERNICIATA



Cod.	cm	Colore	Conf.	Prezzo
SI1575.110B	11x15	bianco	10	1,46 €
SI1577.110N	11x15	nero	10	1,46 €
SI1578.110M	11x15	marrone	10	1,17 €
SI1579.110R	11x15	rosso	10	1,17 €
SI1580.140B	11,4x20	bianco	10	2,16 €
SI1582.140N	11,4x20	nero	10	1,73 €
SI1583.140M	11,4x20	marrone	10	1,73 €
SI1584.140R	11,4x20	rosso	10	1,73 €
SI1585.147B	14,7x24	bianco	10	2,74 €
SI1587.147N	14,7x24	nero	10	2,53 €
SI1588.147M	14,7x24	marrone	10	2,19 €
SI1589.147R	14,7x24	rosso	10	2,19 €
SI1590.167B	16,7x28	bianco	10	3,96 €
SI1592.167N	16,7x28	nero	10	3,17 €
SI1593.167M	16,7x28	marrone	10	3,17 €
SI1594.167R	16,7x28	rosso	10	3,17 €
SI1595.177B	17,7x34	bianco	10	4,79 €
SI1597.177N	17,7x34	nero	10	3,83 €
SI1598.177M	17,7x34	marrone	10	3,83 €
SI1599.177R	17,7x34	rosso	10	3,83 €
SI1600.218B	21,8x38	bianco	10	4,33 €
SI1602.218N	21,8x38	nero	10	4,33 €
SI1603.218M	21,8x38	marrone	10	4,33 €
SI1604.218R	21,8x38	rosso	10	4,33 €

## MENSOLA PESANTE SENZA SAETTA

Spessore 4 mm.  
Larghezza 20 mm.

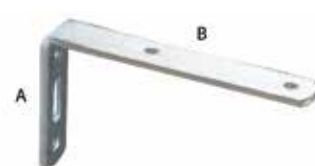

Cod.	A x B cm	Conf.	Prezzo
SI25.06	7x6	40	0,34 €
SI26.08	7x8	40	0,39 €
SI27.10	7x10	40	0,57 €
SI28.12	7x12	40	0,62 €
SI29.15	7x15	40	0,69 €
SI30.20	7x20	40	0,87 €

## MENSOLA PESANTE

Spessore 5 mm.  
Larghezza 30 mm.

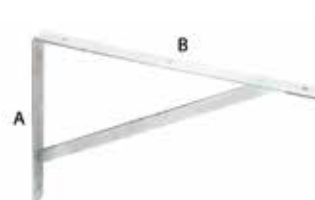

Cod.	A x B cm	Conf.	Prezzo
SI765.30	21x30	10	5,83 €
SI766.35	24x35	10	6,13 €
SI767.40	27x40	10	7,31 €
SI769.50	33x50	1	9,15 €

## MENSOLA PESANTE VERNICIATA DI BIANCO

Spessore 5 mm.  
Larghezza 30 mm.

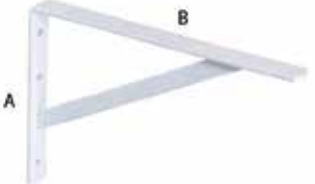

Cod.	A x B cm	Conf.	Prezzo
SI771.30	21x30	10	6,77 €
SI773.40	27x40	10	8,34 €
SI775.50	33x50	10	10,55 €

## MENSOLA PESANTE CON SAETTA



Cod.	cm	Conf.	Prezzo
024542	15	20	1,25 €
024543	20	20	1,46 €
024544	25	20	1,65 €
024545	30	20	1,88 €
024546	35	20	1,52 €

**MENSOLA PESANTE VERNICIATA DI GRIGIO**

Spessore 5 mm.  
Larghezza 30 mm.



Cod.	A x B cm	Conf.	Prezzo
<b>SI777.30</b>	21x30	10	6,27 €
<b>SI779.40</b>	27x40	10	8,34 €
<b>SI781.50</b>	33x50	10	10,55 €

**GANCIO STIVATUTTO**

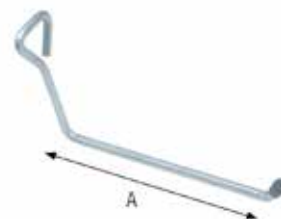

Cod.	A mm	Conf.	Prezzo
<b>SI990</b>	250	10	6,29 €

**SUPER REGGIMENSOLA TROPICALIZZATA**

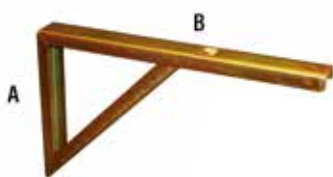
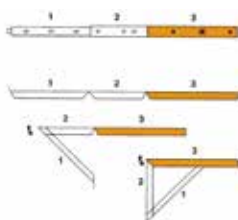

Cod.	A - h cm	B - L cm	Conf.	Prezzo
<b>SI127.30</b>	18	30	10	2,95 €
<b>SI128.40</b>	18	40	10	3,24 €
<b>SI340.50</b>	18	50	10	4,40 €

**GANCIO STIVATUTTO DOPPIO**



Cod.	A mm	Conf.	Prezzo
<b>SI992</b>	250	10	8,71 €

**MENSOLA REGOLABILE**



Cod.	cm	Conf.	Prezzo
<b>131000</b>	45x40x80	1	24,90 €

**GANCIO STIVATUTTO AD ANELLO**



Cod.	A mm	Conf.	Prezzo
<b>SI994</b>	90	10	6,67 €

**ANTIVIBRANTI IN GOMMA**



Cod.	mm	Pz	Conf.	Prezzo
<b>AG08.30X20</b>	30x20x8	4	1	9,03 €
<b>AG08.40X40</b>	40x40x8	4	1	11,30 €

**TELO PROTETTIVO PER CONDIZIONATORE**



Cod.	mm	Conf.	Prezzo
<b>063887</b>	700x550x250	1	22,80 €
<b>063520</b>	840x640x340	1	25,45 €
<b>063521</b>	860x840x325	1	27,55 €

**GANCIO STIVATUTTO DOPPIO**

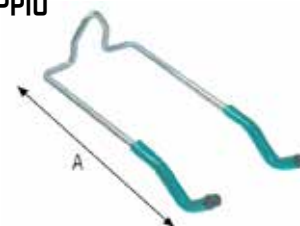

Cod.	mm	Conf.	Prezzo
<b>SI995</b>	320	10	9,91 €

**GANCIO STIVATUTTO**

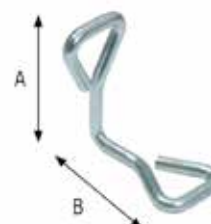

Cod.	AxB mm	Conf.	Prezzo
<b>SI996</b>	90x90	10	6,29 €



## GANCIO STIVATUTTO

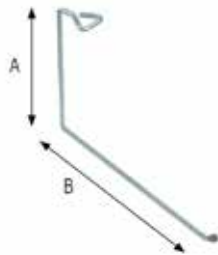

Cod.	AxB mm	Conf.	Prezzo
SI997	300x420	10	8,00 €

## POZZETTO IN OTTONE CON MOLLA



Cod.	Ø mm	Conf.	Prezzo
SI260.06	6	50	1,77 €
SI261.08	8	50	2,32 €
SI262.10	10	50	2,59 €
SI263.12	12	50	2,79 €
SI264.14	14	50	3,51 €
SI268.16	16	50	3,67 €

## GANCIO STIVATUTTO

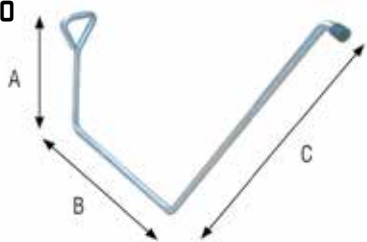

Cod.	AxBxC mm	Conf.	Prezzo
SI998	180x250x420	10	8,00 €

## ATTACCAGLIA A CODA DI RONDINE OTTONATA



Cod.	Descrizione	Conf.	Prezzo
SI220	n° 1	200	0,04 €
SI221.2	n° 2	200	0,05 €
SI222.3	n° 3	200	0,07 €

## REGGITUBO LATERALE PER ARMADI



Cod.	Ø mm	Acciaio	Conf.	Prezzo
SI113	18	zincato	100	0,16 €

## ATTACCAGLIA PER MOBILI PENSILI



Cod.	Descrizione	Conf.	Prezzo
SI01	regolabile	100	0,47 €

## REGGITUBO LATERALE IN FERRO



Cod.	Ø mm	Acciaio	Conf.	Prezzo
SI275	15	cromato	50	1,54 €

## ATTACCAGLIA PER BARRA



Cod.	Descrizione	Conf.	Prezzo
SI49	regolabile	100	0,47 €

## POZZETTO IN OTTONE SENZA MOLLA



Cod.	Ø mm	Conf.	Prezzo
SI150.06	6	100	0,87 €
SI152.10	10	100	1,05 €
SI153.12	12	100	1,26 €

## ATTACCAGLIA QUADRA A INSERTO ZINCATA



Cod.	Spessore mm	Conf.	Prezzo
SI408	1,5	100	0,13 €

**ATTACCAGLIA OVALE A INSERTO ZINCATA**



Cod.	Spessore mm	Conf.	Prezzo
<b>SI409</b>	1,5	100	0,10 €

**PIASTRINA DIRITTA FORATA**



Cod.	Spessore mm	mm	Conf.	Prezzo
<b>SI143.10</b>	2	20x100	100	0,19 €
<b>SI144.20</b>	2	20x200	100	0,26 €
<b>SI145.30</b>	2	20x300	100	0,41 €

**BARRA APPENDIPENSILI**



Cod.	Spessore mm	mm	Conf.	Prezzo
<b>SI41</b>	1,2	50x2000	200	4,63 €

**ATTACCAGLIA LARGA**



Cod.	Spessore mm	mm	Conf.	Prezzo
<b>SI36.06</b>	1,5	19x60	100	0,09 €
<b>SI37.08</b>	1,5	19x80	100	0,12 €
<b>SI38.10</b>	1,5	19x100	100	0,14 €
<b>SI39.12</b>	1,5	19x120	100	0,13 €
<b>SI40.14</b>	1,5	19x140	100	0,15 €

**ATTACCAGLIA STAMPATA**



Cod.	Spessore mm	mm	Conf.	Prezzo
<b>SI50</b>	1,5	20	100	0,16 €

**ATTACCAGLIA DOPPIA PESANTE**



Cod.	Spessore mm	mm	Conf.	Prezzo
<b>SI76</b>	1,5	19x100	200	0,36 €

**ATTACCAGLIA DESTRA/SINISTRA**



Cod.	Varie	Conf.	Prezzo
<b>SI161.DX</b>	destra	50	0,18 €
<b>SI162.SX</b>	sinistra	50	0,18 €

**PIASTRINE AD ANGOLO TROPICALIZZATE**



Cod.	Spessore mm	mm	Conf.	Prezzo
<b>SI317TR</b>	2	30x30x36	100	0,14 €

**PIASTRINE AD ANGOLO TROPICALIZZATE**



Cod.	Spessore mm	mm	Conf.	Prezzo
<b>SI336TR</b>	2	30x30x70	100	0,24 €

**CAVALLOTTO ZINCATO TONDO 927**



Cod.	mm	Conf.	Prezzo
<b>027969</b>	60x20	50	1,16 €

**CAVALLOTTO ZINCATO TONDO 928**

Pieghevole.



Cod.	mm	Conf.	Prezzo
<b>027970</b>	60x20	50	3,48 €

## LASTRINE DIRITTE



Cod.	Spessore mm	mm	Conf.	Prezzo
SI02.04	2	15x40	100	0,07 €
SI04.06	2	15x60	100	0,09 €
SI06.08	2	15x80	100	0,10 €
SI08.10	2	15x100	100	0,12 €
SI10.12	2	15x120	100	0,15 €
SI12.14	2	15x140	100	0,16 €
SI14.16	2	15x160	100	0,18 €
SI16.18	2	15x180	100	0,18 €
SI18.20	2	15x200	100	0,23 €

## LASTRINE AD ANGOLO



Cod.	Spessore mm	mm	Conf.	Prezzo
SI98.2X2	2	15x20x20	100	0,07 €
SI03.3X3	2	15x30x30	100	0,09 €
SI05.4X4	2	15x40x40	100	0,10 €
SI07.5X5	2	15x50x50	100	0,12 €
SI09.6X6	2	15x60x60	100	0,15 €
SI11.7X7	2	15x70x70	100	0,16 €
SI13.8X8	2	15x80x80	100	0,19 €
SI17.10X10	2	15x100x100	100	0,23 €

## ANGOLI DI RINFORZO



Cod.	Tipo	Spessore mm	mm	Conf.	Prezzo
SI61.04	leggero	1,8	40	100	0,12 €
SI62.04	leggero	1,8	50	100	0,12 €
SI63.06	leggero	1,8	60	100	0,15 €
SI65.08	pesante	2	80	100	0,29 €
SI66.10	pesante	2	100	50	0,36 €
SI67.12	pesante	2	120	50	0,41 €
SI68.14	pesante	2	140	50	0,46 €

## PIASTRINE QUADRATE ZINCATE



Cod.	Spessore mm	mm	Conf.	Prezzo
SI57.4X4	1	40x40	200	0,10 €

## PIASTRINE DIRITTE CON 4 FORI



Cod.	Spessore mm	Ø mm	mm	Conf.	Prezzo
SI736.67X40	1	5	67x40	100	0,15 €

## PIASTRINE DIRITTE CON 6 FORI



Cod.	Spessore mm	Ø mm	mm	Conf.	Prezzo
SI737.86X40	1	5	86x40	100	0,17 €

## PIASTRINE AD ANGOLO CON 4 FORI



Cod.	Spessore mm	Ø mm	mm	Conf.	Prezzo
SI738.21X21	1	5	21x21	100	0,16 €

## PIASTRINE AD ANGOLO CON 6 FORI



Cod.	Spessore mm	Ø mm	mm	Conf.	Prezzo
SI739.21X21	1	5	21x21	100	0,19 €

## PIASTRINE DI GIUNZIONE AD ANGOLO



Cod.	Spessore mm	mm	Conf.	Prezzo
SI43.3X3	2	30x30x30	50	0,16 €
SI44.4X4	2	30x40x40	50	0,19 €
SI45.5X5	2	30x50x50	50	0,23 €
SI107.6X6	2	30x60x60	50	0,30 €
SI108.8X8	2	30x80x80	50	0,38 €
SI109.100X100	2	30x100x100	50	0,45 €

## PIASTRINE PESANTI AD ANGOLO



Cod.	spessore mm	mm	Conf.	Prezzo
SI112.4,5X4,5	2,5	40x45x45	100	0,38 €

**PIASTRINA DI GIUNZIONE DIRITTA**



Cod.	Spessore mm	mm	Conf.	Prezzo
SI46.04	2	30x40	50	0,14 €
SI47.06	2	30x60	50	0,16 €
SI48.08	2	30x80	50	0,19 €
SI59.10	2	30x100	50	0,23 €

**STAFFA PER TRAVI INCLINATE**



Cod.	Spessore mm	mm	Conf.	Prezzo
SI583.70	3	70x70x80	15	3,44 €
SI584.90	3	90x90x95	10	4,03 €

**PIASTRINA PESANTE DIRITTA**



Cod.	Spessore mm	mm	Conf.	Prezzo
SI111.4X9	2,5	40x40x90	100	0,38 €

**PIASTRINA PESANTE DIRITTA**



Cod.	Spessore mm	mm	Conf.	Prezzo
SI350.080	2,5	50x80	50	0,46 €
SI352.120	2,5	50x120	50	0,69 €
SI354.160	2,5	50x160	25	0,88 €
SI356.200	2,5	50x200	25	1,01 €

**PIASTRINA PESANTE ANGOLO 135°**



Cod.	Spessore mm	mm	Conf.	Prezzo
SI389.80X80	2,5	50x80x80	25	0,88 €

**PIASTRINA PESANTE DIRITTA**



Cod.	Spessore mm	mm	Conf.	Prezzo
SI394.170	2,5	65x170	25	1,11 €

**PIASTRA A T**



Cod.	Spessore mm	mm	Conf.	Prezzo
SI405.160	2,5	160x45x100	20	1,43 €

**PIASTRINA PESANTE AD ANGOLO**



Cod.	Spessore mm	mm	Conf.	Prezzo
SI358.40X40	2,5	50x40x40	50	0,50 €
SI360.60X60	2,5	50x60x60	50	0,69 €
SI362.80X80	2,5	50x80x80	25	0,88 €
SI364.100X100	2,5	50x100x100	25	1,01 €

**PIASTRINA PESANTE ANGOLO 135°**



Cod.	Spessore mm	mm	Conf.	Prezzo
SI418.60X60	2,5	100x60x60	25	0,95 €

**PIASTRINA PESANTE DIRITTA**



Cod.	Spessore mm	mm	Conf.	Prezzo
SI387.160	2,5	50x160	25	0,70 €

## PIASTRINA PESANTE AD ANGOLO



Cod.	Spessore mm	mm	Conf.	Prezzo
<b>SI392.80X80</b>	2,5	50x80x80	25	0,88 €

## SUPPORTO APERTO UNIVERSALE PER TRAVI



Cod.	Spessore mm	mm	Conf.	Prezzo
<b>SI1245</b>	4	193	10	3,15 €

## PIASTRINA PESANTE AD ANGOLO



Cod.	Spessore mm	mm	Conf.	Prezzo
<b>SI395.85X85</b>	2,5	65x85x85	25	1,02 €

## PIASTRINA PESANTE



Cod.	Spessore mm	mm	Conf.	Prezzo
<b>SI363.60X60</b>	2,5	65x60x60	50	0,95 €

## PIASTRINA PESANTE AD ANGOLO



Cod.	Spessore mm	mm	Conf.	Prezzo
<b>SI397.100X100</b>	2,5	90x100x100	20	1,66 €

## PIASTRINA PESANTE DIRITTA



Cod.	Spessore mm	mm	Conf.	Prezzo
<b>SI366.080</b>	2,5	100x80	25	0,88 €
<b>SI368.120</b>	2,5	100x120	25	0,95 €
<b>SI370.160</b>	2,5	100x160	20	1,50 €
<b>SI372.200</b>	2,5	100x200	20	1,79 €

## PIASTRINA PESANTE DIRITTA



Cod.	Spessore mm	mm	Conf.	Prezzo
<b>SI396.200</b>	2,5	90x200	20	1,66 €

## PIASTRINA PESANTE AD ANGOLO



Cod.	Spessore mm	mm	Conf.	Prezzo
<b>SI374.40X40</b>	2,5	100x40x40	25	0,88 €
<b>SI376.60X60</b>	2,5	100x60x60	25	1,20 €
<b>SI378.80X80</b>	2,5	100x80x80	20	1,50 €
<b>SI380.100X100</b>	2,5	100x100x100	20	1,79 €

## SUPPORTO PER TRAVI CHIUSO



Cod.	Spessore mm	mm	Conf.	Prezzo
<b>SI1086.60X100</b>	2	60x100	15	2,32 €
<b>SI656.80X120</b>	2	80x120	15	3,23 €
<b>SI657.100X140</b>	2	100x140	15	3,76 €

## PIASTRINA DIRITTA FORATA



Cod.	Spessore mm	mm	Conf.	Prezzo
<b>SI1095.200</b>	4	20x200	50	0,65 €

## PIASTRINA PIEGATA FORATA



Cod.	Spessore mm	mm	Conf.	Prezzo
<b>SI1097.050</b>	4	20x50x50	50	0,40 €
<b>SI1098.100</b>	4	20x100x100	50	0,52 €
<b>SI1099.150</b>	4	20x150x150	50	0,96 €

## SUPPORTO PER TRAVI DA PIANTARE



Cod.	Cuneo mm	Trave mm	Conf.	Prezzo
<b>SI168.70X70</b>	400	70x70	1	24,65 €
<b>SI169.90X90</b>	400	90x90	1	29,00 €

## SUPPORTO APERTO UNIVERSALE PER TRAVI



Cod.	Spessore mm	mm	Conf.	Prezzo
<b>SI585.100</b>	2	100	15	3,00 €
<b>SI586.120</b>	2	120	15	3,54 €

## SUPPORTO UNIVERSALE PER TRAVI TROPICALIZZATO



Cod.	Spessore mm	mm	Conf.	Prezzo
<b>SI369.130</b>	2,5	45x45x130	20	1,55 €

## SUPPORTO PER TRAVI APERTO



Cod.	Spessore mm	mm	Conf.	Prezzo
<b>SI381.60X100</b>	2	60x100	15	2,73 €
<b>SI382.80X120</b>	2	80x120	15	2,58 €
<b>SI383.100X140</b>	2	100x140	15	3,76 €

## BATTISCOPA PVC LINE IN PVC ESPANSO

Linea di battiscopa resistente agli urti. Facilità e rapidità di applicazione viene fissato con adesivo.



Cod.	L x H cm	Colore	Conf.	Prezzo
<b>500545</b>	200x7	marrone scuro	1	2,74 €
<b>500555</b>	200x7	bianco	1	2,74 €

## STAFFA A PAVIMENTO



Cod.	Spessore mm	mm	Conf.	Prezzo
<b>SI588.90X90</b>	3	90x90	10	12,20 €

## PARASPIGOLI PVC LINE IN PVC ESPANSO

Linea di paraspigoli resistente agli urti. Facilità e rapidità di applicazione viene fissato con adesivo.

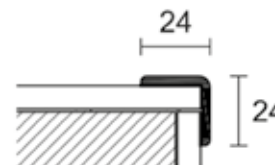

Cod.	L cm	Colore	Conf.	Prezzo
<b>510555</b>	300	bianco	50	3,63 €

## PISTRINA CON DADO SALDATO



Cod.	Spessore mm	mm	Dado	Conf.	Prezzo
<b>SI606.08</b>	3	50x50	M8	50	1,09 €

## PARASPIGOLI PVC LINE IN PVC ESPANSO

Linea di paraspigoli resistente agli urti. Facilità e rapidità di applicazione viene fissato con adesivo.

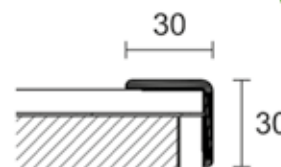

Cod.	L cm	Colore	Conf.	Prezzo
<b>511555</b>	300	bianco	50	4,16 €

## PROFILO PROJONT A T



Per pavimenti di pari livello con il fine di separazione, protezione e decorazione. Risultata ideale anche come copertura di eventuali imperfezioni dovute al taglio o alla posa. Da utilizzare con sigillanti o adesivi.

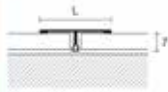

In blister da 10 pz.

Cod.	L cm	Colore	Descrizione	Conf.	Prezzo
520008	90	argento	alluminio	1	4,92 €
520016	90	lucido	ottone	1	8,55 €

## PROFILO PROLEVEL IN ALLUMINIO ANODIZZATO 29x5,5 MM



Per pavimenti di differente livello. Sono una linea di profili di raccordo per pavimentazioni di basso spessore già posate.

In blister da 10 pz.

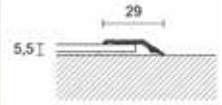

Cod.	L cm	Colore	Descrizione	Conf.	Prezzo
520952	93	argento	adesivo	1	7,09 €
520953	93	oro	adesivo	1	7,09 €
520932	93	argento	con viti	1	6,02 €
520933	93	oro	con viti	1	6,02 €

## PROFILO PROCLASSIC IN OTTONE LUCIDO



Per pavimenti di pari livello.

In blister da 10 pz.

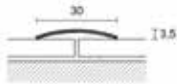

Cod.	L cm	Conf.	Prezzo
520216	103	1	10,80 €
520210	103	1	9,35 €

## PROFILO PROLEVEL IN ALLUMINIO ANODIZZATO 35x8 MM



Per pavimenti di differente livello, permette l'eliminazione del gradino tra pavimenti con dislivello 8 mm.

In blister da 10 pz.

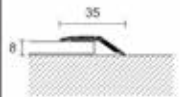

Cod.	L cm	Colore	Descrizione	Conf.	Prezzo
542330	90	argento	adesivo	1	9,75 €
542336	90	oro	adesivo	1	9,75 €
542312	90	argento	con viti	1	8,65 €

## PROFILO PROCLASSIC IN ALLUMINIO ANODIZZATO 25x2,2 MM



Per pavimenti di pari livello.

In blister da 10 pz.

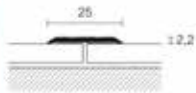

Cod.	L cm	Colore	Descrizione	Conf.	Prezzo
527092	93	argento	adesivo	1	6,19 €
527099	93	oro	adesivo	1	6,19 €
527074	93	argento	con viti	1	5,12 €
527080	93	oro	con viti	1	5,12 €

## PROFILO IN ALLUMINIO ANODIZ. ARGENTO PIATTO - 2 M



Cod.	mm	Colore	Conf.	Prezzo
510104	12x2	argento	10	4,61 €
510112	15x2	argento	10	5,44 €
510120	20x2	argento	10	6,10 €
510128	25x2	argento	10	6,92 €
510136	30x2	argento	10	7,90 €
510095	40x2	argento	10	10,65 €
510099	50x2	argento	10	13,45 €

## PROFILO PROCLASSIC IN ALLUMINIO ANODIZZATO 35x2,2 MM



Per pavimenti di pari livello.

In blister da 10 pz.

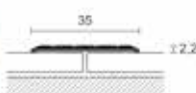

Cod.	L cm	Colore	Descrizione	Conf.	Prezzo
522553	93	argento	adesivo	1	7,09 €
522554	93	oro	adesivo	1	7,09 €
522533	93	argento	con viti	1	6,03 €
522534	93	oro	con viti	1	6,03 €

## PROFILO IN ALLUMINIO ANODIZ. ARGENTO ANGOLARE - 2 M

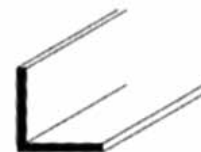

Cod.	mm	Colore	Conf.	Prezzo
510144	10x10x1	argento	10	4,61 €
510152	15x15x1	argento	10	5,14 €
510160	20x20x1	argento	10	6,21 €
510168	25x25x1	argento	10	6,92 €
510176	30x30x1	argento	10	7,59 €
510384	40x40x1,5	argento	10	13,75 €
510382	50x50x2	argento	10	24,05 €

**PROFILO IN ALLUMINIO ANODIZ. ARGENTO ANGOLARE A L - 2 M**



Cod.	mm	Colore	Conf.	Prezzo
510184	15x10x1	argento	10	4,68 €
510192	20x10x1	argento	10	5,01 €
510200	30x15x1	argento	10	6,36 €

**PROFILO IN ALLUMINIO ANODIZ. ARGENTO TUBO QUADRATO - 2 M**



Cod.	mm	Colore	Conf.	Prezzo
510312	10x10x1	argento	10	6,21 €
510320	15x15x1	argento	10	8,14 €
510328	20x20x1	argento	10	10,10 €

**PROFILO IN ALLUMINIO ANODIZ. ARGENTO CANALINO A U - 2 M**



Cod.	mm	Colore	Conf.	Prezzo
510208	8x8x1	argento	10	4,31 €
510224	10x15x1	argento	10	6,10 €
510218	12x12x1	argento	10	6,10 €

**PROFILO IN ALLUMINIO ANODIZ. ARGENTO TUBO RETTANGOLARE - 2 M**



Cod.	mm	Colore	Conf.	Prezzo
510336	20x10x1	argento	10	8,14 €
510344	30x15x1	argento	10	10,35 €

**PROFILO IN ALLUMINIO ANODIZ. ARGENTO CANALINO A DOPPIA U - 2 M**

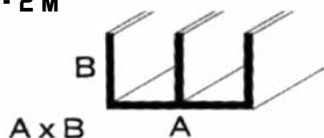

Cod.	mm	Colore	Conf.	Prezzo
510232	16x7x1	argento	10	5,59 €

**PROFILO IN ALLUMINIO ANODIZ. ARGENTO PROFILO A T - 2 M**



Cod.	mm	Colore	Conf.	Prezzo
510352	15x15x1,5	argento	10	6,48 €
510360	25x25x1,5	argento	10	9,15 €

**PROFILO IN ALLUMINIO ANODIZ. ARGENTO UNGHIETTA - 2 M**



Cod.	mm	Colore	Conf.	Prezzo
510264	18x1	argento	10	5,16 €
510272	22x1	argento	10	5,44 €
510280	25x1	argento	10	5,59 €

**PROFILO IN ALLUMINIO ANODIZZATO PROFILO TONDO PIENO - 2 M**

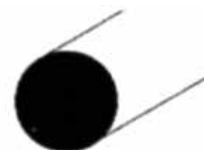

Cod.	Ø mm	Colore	Conf.	Prezzo
510368	8	argento	10	7,45 €
509092	10	argento	10	10,35 €

**PROFILO IN ALLUMINIO ANODIZ. ARGENTO TUBO ROTONDO - 2 M**



Cod.	mm	Colore	Conf.	Prezzo
509052	12x1	argento	10	5,87 €
510288	15x1	argento	10	6,36 €
510296	18x1	argento	10	7,20 €
510304	20x1	argento	10	7,95 €
509060	25x1,5	argento	10	12,90 €

**PROFILO IN ALLUMINIO ANODIZZATO PROFILO QUADRATO PIENO - 2 M**



Cod.	Ø cm	Colore	Conf.	Prezzo
510376	8x8	argento	10	8,89 €
510394	10x10	argento	10	12,75 €



## PROFILO IN ALLUMINIO VERN. BIANCO PIATTO - 2 M



Cod.	mm	Colore	Conf.	Prezzo
511612	15x2	bianco	5	5,54 €
511620	20x2	bianco	5	6,17 €

## PROFILO IN ALLUMINIO VERN. BIANCO ANGOLARE - 2 M

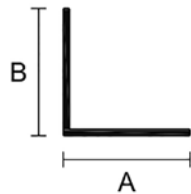

Cod.	mm	Colore	Conf.	Prezzo
511644	10x10x1	bianco	5	4,68 €
511652	15x15x1	bianco	5	5,21 €
511660	20x20x1	bianco	5	6,30 €
511668	25x25x1	bianco	5	7,00 €
511676	30x30x1	bianco	5	7,65 €
511684	40x40x1,5	bianco	5	13,90 €

## PROFILO IN ALLUMINIO VERN. BIANCO ANGOLARE L - 2 M

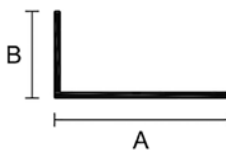

Cod.	mm	Colore	Conf.	Prezzo
511692	15x10x1	bianco	5	4,78 €
511700	20x10x1	bianco	5	5,06 €
511708	30x15x1	bianco	5	6,45 €

## PROFILO IN ALLUMINIO BRILLANTATO PIATTO - 2 M



Cod.	mm	Colore	Conf.	Prezzo
510115	15x2	cromo	5	8,24 €
510123	20x2	cromo	5	9,03 €
510131	25x2	cromo	5	10,15 €

## PROFILO IN ALLUMINIO BRILLANTATO ANGOLARE - 2 M

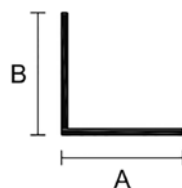

Cod.	mm	Colore	Conf.	Prezzo
510147	10x10x1	cromo	5	7,30 €
510155	15x15x1	cromo	5	7,86 €
510163	20x20x1	cromo	5	9,21 €
510171	25x25x1	cromo	5	10,20 €

## PIEDINO PVC CALZANTE NERO



Cod.	Ø mm	Conf.	Prezzo
063958	12	100	9,92 €
063959	14	100	11,80 €
063960	16	100	13,60 €
063961	18	100	15,80 €
063962	20	100	18,50 €
063963	22	100	19,85 €
063964	25	50	8,18 €
063965	26	50	13,40 €
063966	28	50	16,30 €
063967	30	50	18,70 €

## PIEDINO QUADRO ALETTATO

Polietilene nero.



Cod.	mm	Conf.	Prezzo
052643	12x12	200	0,05 €
052644	18x18	200	0,06 €
052645	20x20	200	0,09 €
052646	25x25	200	0,11 €
052647	30x30	200	0,14 €
052648	35x35	200	0,20 €
052649	40x40	100	0,26 €
052650	50x50	100	0,37 €
052651	60x60	100	28,30 €

## PIEDINO TONDO ALETTATO

Polietilene nero.



Cod.	Ø mm	Conf.	Prezzo
0526341	12	200	3,69 €
052635	14	200	0,05 €
052636	16	200	0,04 €
052637	18	200	0,05 €
052638	20	200	0,05 €
052639	22	200	0,07 €
0526391	24	200	4,37 €
052640	25	200	0,08 €
0526392	26	200	5,50 €
0526393	28	100	6,27 €
052641	30	100	0,11 €
052642	32	100	0,12 €
0526423	35	100	8,77 €
0526424	40	100	12,20 €
0526425	45	100	15,95 €
0526426	50	100	19,50 €
0526427	60	100	27,05 €

**PIEDINO PVC RETTANGOLARE NERO**



Cod.	mm	Conf.	Prezzo
063968	15x30	50	7,63 €
063969	20x30	50	8,46 €
063970	20x40	50	9,99 €
063971	20x50	50	11,00 €
063972	25x50	50	14,55 €
063973	30x60	50	22,50 €

**AVVOLGITORE PESANTE DA INCASSO**

Completo di placca.



Cod.	m	Interasse fori mm	Conf.	Prezzo
1019E.6125	6	125	50	3,94 €
1019E.6165	6	165	50	5,40 €
1019E.6185	6	185	50	5,67 €
1019E.8165	8	165	50	5,90 €
1019E.8185	8	185	50	6,12 €
1019E.12185	12	185	50	7,51 €

**PLACCA PER AVVOLGITORE PESANTE DA INCASSO**



Cod.	Interasse fori mm	Conf.	Prezzo
1019EP:125	125	25	0,81 €
1019EP:165	165	25	0,79 €
1019EP:185	185	25	0,99 €

**CUSTODIA IN PLASTICA**



Cod.	Interasse fori mm	Conf.	Prezzo
1040MAP	185	50	2,27 €

**CUSTODIA IN PLASTICA**



Cod.	Interasse fori mm	Conf.	Prezzo
1040MI	165	100	1,62 €

**RIDUTTORE PER RULLO OTTAGONALE**



Cod.	mm	Conf.	Prezzo
1010F	250/200	1	32,60 €

**RIDUTTORE PER RULLO LEGNO IN FERRO ZINCATO**



Cod.	mm	Conf.	Prezzo
1010L	250	7	30,30 €

**PULEGGIA PER RULLO OTTAGONALE IN FERRO ZINCATO**



Cod.	mm	Conf.	Prezzo
1080.200	200	15	3,55 €
1080.220	220	15	4,66 €

**PULEGGIA PER RULLO LEGNO IN FERRO ZINCATO**



Cod.	mm	Conf.	Prezzo
1020.200	200	20	3,16 €
1020.220	220	20	3,50 €

**RULLO OTTAGONALE KS 60 IN FERRO ZINCATO**



Cod.	m	Conf.	Prezzo
1090.16	1,6	10	6,92 €
1090.22	2,2	10	9,51 €

**CALOTTA CON PERNO IN FERRO ZINCATO**



Cod.	Descrizione	Conf.	Prezzo
1086	sagomata	100	0,95 €

## FORCELLA



Cod.	Descrizione	Conf.	Prezzo
1014	in acciaio	50	0,95 €

## SQUADRA D'ARRESTO CON GOMMINO



Cod.	Descrizione	Conf.	Prezzo
1008G	con gommino	100	0,52 €

## GUIDACINGHIA RULLI NYLON TRASVERSALI



Cod.	Descrizione	Conf.	Prezzo
1002T	rulli in nylon	50	0,62 €

## TAPPO CONICO D'ARRESTO



Cod.	mm	Colore	Conf.	Prezzo
1006G.30	30	grigio	100	0,20 €
1006G.40	40	grigio	100	0,24 €
1006M.30	30	marrone	100	0,20 €
1006M.40	40	marrone	100	0,24 €

## GUIDACINGHIA RULLI FERRO



Cod.	Descrizione	Conf.	Prezzo
1002F	rulli in ferro	50	0,83 €

## GUIDACINGHIA RULLI NYLON



Cod.	Descrizione	Conf.	Prezzo
1002N	rulli in nylon	50	0,62 €

## BLOCCATAPPARELLE



Cod.	Descrizione	Conf.	Prezzo
053653	per avvolgibili acciaio zincato	25	1,68 €
062129	per avvolgibili bronzati	25	2,42 €

## RULLO DI RINVIO IN NYLON IN FERRO ZINCATO



Cod.	mm	Conf.	Prezzo
1003A	30	20	1,08 €

## BLOCCATAPPARELLE



Cod.	Descrizione	Conf.	Prezzo
1058	per avvolgibili pastica	50	1,33 €

## RULLO DI RINVIO NYLON



Cod.	mm	Conf.	Prezzo
1003	40		1,19 €

## GANCIO PER RULLO



Cod.	Descrizione	Conf.	Prezzo
1005	in acciaio	150	0,32 €

## GANCIO PER RULLO LEGNO



Cod.	Descrizione	Conf.	Prezzo
1013	in acciaio	250	0,13 €

## GANCIO PER TAPPARELLE



Cod.	Descrizione	Conf.	Prezzo
1001B	per rullo ferro	150	0,14 €

## GANCIO PER TAPPARELLE FISSO



Cod.	mm	Conf.	Prezzo
1011.42	42	250	0,11 €

## GANCIO PER TAPPARELLE MOBILE



Cod.	mm	Conf.	Prezzo
1023.51	51	200	0,12 €

## CUSCINETTO A MURARE CON ZANCA



Cod.	Descrizione	Conf.	Prezzo
1060	in acciaio		1,36 €

## CUSCINETTO SENZA ZANCA



Cod.	Descrizione	Conf.	Prezzo
1060S	in acciaio	1	1,12 €

## SUPPORTO EXPORT



Cod.	Descrizione	Conf.	Prezzo
1062	in acciaio	1	0,96 €

## CUSCINETTO A DISCO



Cod.	Descrizione	Conf.	Prezzo
1063	in acciaio	1	1,09 €

## SUPPORTO PER RIDUTTORE



Cod.	mm	Conf.	Prezzo
10047	30	50	3,38 €

## CINTINO PER TAPPARELLE

In rotolo. In cotone con rinforzo in nylon. Bicolore.



Cod.	Descrizione	g/m	m	Conf.	Prezzo
039428	FU2961	18	50	1	15,75 €
04.01.050	FU2964	27	22x50	1	22,55 €

## CINTINO PER TAPPARELLE

Per porta finestra. In cotone con rinforzo in nylon. Bicolore.



Cod.	Descrizione	g/m	m	Conf.	Prezzo
039431	FU2963	18	7,5	1	2,66 €
04.01.054	FU2966	27	7,5	1	3,70 €

## CINTINO PER TAPPARELLE

Per finestre. In cotone con rinforzo in nylon. Bicolore.



Cod.	Descrizione	g/m	m	Conf.	Prezzo
039430	FU2962	18	5,5	1	2,16 €
04.01.052	FU2965	27	5,5	1	2,80 €

## TRECCIA NYLON PER VENEZIANE



Cod.	Ø mm	m	Colore	Conf.	Prezzo
041115	3	20	bianca	1	2,18 €
041117	3	20	verde	1	2,18 €
041118	3	20	avana	1	2,17 €

## TRECCIA NYLON PER VENEZIANE

Treccia per tendaggi.



Cod.	mm	m	Colore	Conf.	Prezzo
027387	3	200	verde	1	14,30 €
039950	3	400	bianca	1	25,60 €
039958	3	400	verde	1	26,40 €
056785	3	400	verde scuro	1	28,55 €
036062	3	500	bianca	1	32,00 €
036063	3	500	verde	1	33,00 €
030242	3	500	verde scuro	1	33,00 €

## ZANZARIERA IN ALLUMINIO BRILLANTE

Zanzariera adattabile a finestre e porte di ogni dimensione. Riduce la visibilità dall'esterno. Non ossida.



Cod.	m	Pz	Conf.	Prezzo
053949	0,80x2,50	16	1	8,95 €
053950	1,00x2,50	16	1	11,05 €
053951	1,20x2,50	16	1	13,30 €

## ZANZARIERA IN ALLUMINIO BRILLANTE

Zanzariera adattabile a finestre e porte di ogni dimensione. Riduce la visibilità dall'esterno. Non ossida.



Cod.	m	Conf.	Prezzo
GA7098	0,50x30	1	48,20 €
GA7099	0,60x30	1	58,00 €
GA7100	0,80x30	1	76,80 €
GA7105	1,00x30	1	96,30 €
GA7110	1,20x30	1	116,00 €

## RETE ZANZARIERA IN FIBRA DI VETRO

Adattabile a finestre e porte di ogni dimensione. Riduce la visibilità dall'esterno.



Cod.	m	Colore	Conf.	Prezzo
GA7120B	0,80x30	bianco	10	43,80 €
GA7125B	1,00x30	bianco	10	54,60 €
GA7130B	1,20x30	bianco	10	65,70 €
GA7135B	1,40x30	bianco	10	76,60 €
GA7120G	0,80x30	grigio	10	37,40 €
GA7125G	1,00x30	grigio	10	46,70 €
GA7130G	1,20x30	grigio	10	56,00 €
GA7135G	1,50x30	grigio	10	70,10 €

## NASTRO ATTACCA&STACCA PER ZANZARIERE

Biadesivo speciale per zanzariere in fibra di vetro ed alluminio 18x14. Può essere rimosso senza lasciare residui.



Cod.	m	mm	Colore	Conf.	Prezzo
PN00280	6,60	10	nero	12	11,60 €

## NASTRO PER ZANZARIERE

Biadesivo speciale per zanzariere in poliestere. Può essere rimosso senza lasciare residui.



Cod.	m	mm	Colore	Conf.	Prezzo
PN00279	6,5	10	neutro	50	2,10 €

## ZANZARIERA PER FINESTRE

Applicazione facile ed immediata con nastro biadesivo rimovibile senza lasciare residui. Adattabile a finestre di ogni dimensione.



Cod.	cm	Colore	Conf.	Prezzo
PN00276	150x130	bianco	24	3,47 €
GA8507	180x150	bianco	24	3,91 €
PN00277	150x130	nero	24	3,47 €
GA8508	180x150	nero	24	3,91 €

## ZANZARIERA PER PORTE E FINESTRE

Applicazione facile ed immediata con nastro biadesivo rimovibile senza lasciare residui. Adattabile a porte e finestre di ogni dimensione.



Cod.	cm	Colore	Conf.	Prezzo
GA8509	75x250x2 teli	bianco	24	5,15 €
GA8510	75x250x2 teli	nero	24	5,15 €

### ZANZARIERA A CALAMITA MAGNETIX

Con calamite che permettono una chiusura automatica e sicura dopo ogni passaggio. Tessuto antipiega in poliestere 55-60 g/m<sup>2</sup>. Montaggio e smontaggio semplice e veloce. Magneti cuciti. Riducibile. Kit completo di nastro biadesivo.

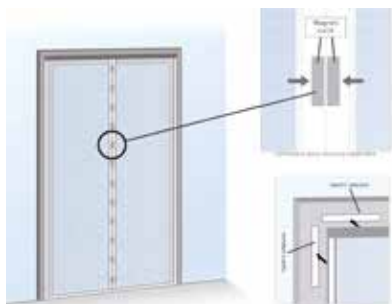

Cod.	cm	Colore	Conf.	Prezzo
ZC150250S	150x250	sun stop	14	20,70 €

### ZANZARIERA A TENDA PER PORTE

Non scolora all'esposizione solare. Kit completo di anelli con ganci e piombini sulla base.



Cod.	cm	Colore	Conf.	Prezzo
GA85133	150x250	verde	15	9,51 €
GA85132	150x250	beige	15	9,51 €
GA85134	150x250	orange fusion	15	12,95 €

### ZANZARIERA A RULLO PER FINESTRE E PORTA

Modello verticale con frizione. Trama molto fitta che impedisce il passaggio di qualsiasi tipo d'insetto. Facile installazione e rimozione.



Cod.	cm	Colore	Conf.	Prezzo
GA8200	80x170	bronzo	6	43,00 €
GA8201	100x170	bronzo	6	45,30 €
GA8202	120x170	bronzo	6	50,30 €
GA8203	140x170	bronzo	4	53,50 €
GA8204	160x170	bronzo	4	56,80 €

GA8501	80x170	bianco RAL 9010	6	43,00 €
GA8502	100x170	bianco RAL 9010	6	45,30 €
GA8503	120x170	bianco RAL 9010	6	50,30 €
GA8504	140x170	bianco RAL 9010	4	53,50 €
GA8512	160x170	bianco RAL 9010	4	56,80 €

PN00262	80x170	marrone	6	43,00 €
PN00264	100x170	marrone	6	45,30 €
PN00266	120x170	marrone	6	50,30 €
PN00268	140x170	marrone	4	53,50 €
PN00270	160x170	marrone	4	56,80 €

### ZANZARIERA ESTENSIBILE

Con telaio in alluminio spazzolato. Prodotto studiato per l'installazione su finestre e porte finestre con tapparella. Trama molto fitta in fibra di vetro. Applicazione facile e istantanea.



Cod.	cm	Descrizione	Conf.	Prezzo
ZE50075	50x75	alluminio	10	11,60 €
ZE50103	70x103	alluminio	10	17,40 €

### ZANZARIERA A RULLO PER PORTA

Modello laterale senza frizione. Ideale per balconi, verande e terrazze. Trama molto fitta che impedisce il passaggio di qualsiasi tipo d'insetto. Facile applicazione e rimozione. Con chiusura servoassistita.



Cod.	cm	Colore	Conf.	Prezzo
GA85131	160x250	bronzo	4	94,20 €
PN00272	160x250	bianco RAL 9010	4	94,20 €
PN00273	160x250	marrone	4	94,20 €

### ZANZARIERA VERTICALE PER FINESTRA PLIXÉ

Adatta per spazi molto ridotti. Facile da montare, riducibile e pratica. Fissaggio tramite viti.



Cod.	cm	Colore	Conf.	Prezzo
ZP110160BR	110x160	bronzo	1	130,50 €
ZP135160BR	135x160	bronzo	1	139,00 €
ZP110160B	110x160	bianco	1	130,50 €
ZP135160B	135x160	bianco	1	139,00 €

### ZANZARIERA LATERALE PER PORTA PLIXÉ

Zanzariera di scorrimento che non ha eguali come praticità e velocità di installazione grazie al telaio di compensazione incluso. Il telaio è riducibile sia in altezza che in lunghezza.



Cod.	cm	Colore	Conf.	Prezzo
ZP150250BR	150x250	bronzo	1	242,50 €
ZP150250B	150x250	bianco	1	226,50 €

## ZANZARIERA PER PORTA BATTENTE

Da applicare nella parte esterna della portata principale. Ideale per porte che affacciano su verande e terrazze. Kit di montaggio completo.



Cod.	cm	Colore	Conf.	Prezzo
PN00990	100x240	bronzo	8	52,10 €
PN00991	100x240	bianco 9010	6	52,10 €
PN00992	100x240	marrone	6	52,10 €

## RETE DI RICAMBIO

Telo ricambio in fibra di vetro con fettuccia per zanzariere Roll.



Cod.	cm	Conf.	Prezzo
ZR2000	80x170	1	16,95 €
ZR2001	100x170	1	20,50 €
ZR2002	120x170	1	26,05 €
ZR2003	140x170	1	30,00 €
ZR2004	160x170	1	33,90 €
ZR2012	160x250	1	51,40 €

## ZANZARIERA ELETTRICA CON GRATA

Moderna, sicura, efficace e facile da pulire. Altamente sicura grazie alla grata esterna completamente protetta, conforme agli standard GS. Ampio vassoio removibile per agevolare la pulizia. Può essere sospesa al muro, al soffitto o posizionata liberamente. Molto silenziosa.



Cod.	W	Raggio d'azione mq	Conf.	Prezzo
057666	8	40	6	45,20 €
057667	10	60	6	48,90 €
057668	15	100	6	57,60 €

## ZANZARIERA ELETTRICA CON ASPIRAZIONE

Utilizza la biotecnologia: corrente d'aria e tecnologia ottica per attirare zanzare e mosche. Prodotto ecologicamente sicuro e innocuo per la salute dell'uomo e degli animali. La lampada può essere utilizzata in ambienti interni.



Cod.	W	Raggio d'azione mq	Conf.	Prezzo
057669	13	80	6	57,70 €

## BANDELLA CUORE DOPPIA T



Cod.	mm	Descrizione	Conf.	Prezzo
131690	200	dx - nero	12	13,95 €
131691	200	sx - nero	12	13,95 €

## BANDELLA CUORE DOPPIA



Cod.	mm	Descrizione	Conf.	Prezzo
131631	100x100	nero	12	6,39 €
131632	150x150	nero	12	6,40 €
131633	180x180	nero	12	6,86 €

## BANDELLA CUORE DOPPIA T



Cod.	mm	Descrizione	Conf.	Prezzo
131606	160	nero	12	10,25 €
131607	200	nero	12	11,50 €

## BANDELLA CUORE



Cod.	mm	Ø mm	Descrizione	Conf.	Prezzo
131660	200	12	nero	24	3,96 €
131661	250	12	nero	24	4,41 €
131662	300	12	nero	24	5,07 €
131663	350	12	nero	24	5,85 €
131664	400	12	nero	24	7,00 €

## BANDELLA CUORE PD



Cod.	mm	Ø mm	Descrizione	Conf.	Prezzo
131684	120x240	8	nero	24	8,21 €
131686	140x220	8	nero	24	8,21 €
131688	160x200	8	nero	24	8,21 €

**BANDELLA CUORE TV**



Cod.	mm	Ø mm	Descrizione	Conf.	Prezzo
131675	140x220	10	nero	24	8,43 €

**FERMO A VITE PIATTO**



Cod.	mm	Ø mm	Descrizione	Conf.	Prezzo
131547	60	6	nero	100	1,71 €

**BANDELLA CUORE T**



Cod.	mm	Ø mm	Descrizione	Conf.	Prezzo
131646	200	12	nero	12	5,79 €

**SPAGNOLETTA NERA KIT**



Cod.	mm	Ø mm	Descrizione	Conf.	Prezzo
131583	120	10	nero	10	15,90 €

**FERMO A MARMO PIATTO**



Cod.	mm	Ø mm	Descrizione	Conf.	Prezzo
131546	58	9	nero	100	1,45 €

**FERMAMANIGLIA PER SPAGNOLETTA**



Cod.	mm	Descrizione	Conf.	Prezzo
131587	83x17	nero	100	2,24 €

**FERMO A MARMO TONDO**



Cod.	mm	Ø mm	Descrizione	Conf.	Prezzo
131543	48	10	nero	100	1,62 €

**ASTA PER SPAGNOLETTA**



Cod.	mm	Ø mm	Descrizione	Conf.	Prezzo
131584	1600	10	nero	10	7,59 €
131585	240	10	nero	10	11,60 €

**FERMO A VITE NERO**



Cod.	Descrizione	Conf.	Prezzo
131551	2 fori	100	1,10 €

**MANIGLIA ARCO**



Cod.	mm	Descrizione	Conf.	Prezzo
131625	225	nero	25	3,24 €



**MANIGLIA CUORE**



Cod.	mm	Descrizione	Conf.	Prezzo
131618	190	nero	25	5,54 €

**ANUBA PER CARDINE**



Cod.	mm	Ø mm	Descrizione	Conf.	Prezzo
131712	M10x25	8	nero	12	2,38 €

**CARDINE AVVITARE**



Cod.	mm	Ø mm	Descrizione	Conf.	Prezzo
131697	M10x60	10	nero	50	4,62 €
131695	M10x60	12	nero	50	4,80 €

**CARDINE CUORE LEGNO**



Cod.	mm	Ø mm	Descrizione	Conf.	Prezzo
131541	200	12	nero	12	4,29 €

**CARDINE A MURARE**



Cod.	mm	Ø mm	Descrizione	Conf.	Prezzo
131538	108	10	nero	24	3,99 €
131539	120	12	nero	24	3,83 €

**CARDINE PIANO LEGNO**



Cod.	mm	Ø mm	Descrizione	Conf.	Prezzo
131549	200	12	nero	24	8,88 €

**CARDINE MURARE + SPINA**



Cod.	Ø mm	Descrizione	Conf.	Prezzo
131689	8	nero	10	1,85 €

**CARDINE PIANO LEGNO**



Cod.	mm	Ø mm	Descrizione	Conf.	Prezzo
131535	200	12	tropicalizzao	12	5,10 €

**SPINA PER CARDINI**



Cod.	Ø mm	Descrizione	Conf.	Prezzo
131693	8	nero	12	1,53 €

**CARDINE AVVITARE + GRANO**



Cod.	mm	Ø mm	Descrizione	Conf.	Prezzo
131711	M10x25	8	nero	60	4,14 €

**SQUADRA CUORE**



Cod.	mm	Ø mm	Descrizione	Conf.	Prezzo
131652	200x230	12	dx - nero	12	9,46 €
131653	200x230	12	sx - nero	12	9,46 €

**BORCHIA 2 PUNTE**



Cod.	mm	Descrizione	Conf.	Prezzo
131526	20x20	nero	200	0,58 €
131527	25x25	nero	200	0,64 €
131528	30x30	nero	200	0,75 €

**CATENACCIO ORIZZONTALE CUORE**



Cod.	mm	Descrizione	Conf.	Prezzo
131563	300	nero	6	15,70 €
131564	400	nero	6	18,35 €

**CATENACCIO VERTICALE CUORE FINALE TONDO ZANCATO**



Cod.	mm	Descrizione	Conf.	Prezzo
131573	280	nero	6	13,55 €

**CATENACCIO VERTICALE CUORE**



Cod.	mm	Descrizione	Conf.	Prezzo
131577	250	nero	6	11,85 €
131578	300	nero	6	13,15 €
131579	400	nero	6	15,95 €
131580	500	nero	6	18,05 €

**CATENACCIO ORIZZONTALE CUORE TONDO**



Cod.	mm	Descrizione	Conf.	Prezzo
131575	300	nero	6	20,05 €
131576	380	nero	6	21,80 €

**CATENACCIO A CARABINA**



Cod.	mm	Descrizione	Conf.	Prezzo
130087	120	nero	20	9,13 €
130088	200	nero	20	9,89 €

**CATENACCIO AVVITARE**



Cod.	mm	Descrizione	Conf.	Prezzo
879050.150	150	nero	15	4,27 €
879050.200	200	nero	15	4,79 €
879050.250	250	nero	15	5,29 €

**GANCIO FERMAPERSIANE OTTONE LUCIDO**



Cod.	mm	Conf.	Prezzo
062830	60	1	2,35 €
062831	80	1	2,59 €
062832	100	1	2,83 €
062833	120	1	3,07 €
062834	140	1	3,56 €

**GANCIO FERMAPERSIANE OTTONE NERO**

Verniciato.



Cod.	mm	Conf.	Prezzo
062835	60	1	2,65 €
062836	80	1	2,89 €
062837	100	1	3,13 €
062838	120	1	3,38 €
062839	140	1	3,86 €

**FERMA PERSIANE AUTOMATICO IN PLASTICA**



Con vite e tassello



Cod.	Descrizione	Conf.	Prezzo
879638.NER	vite normale	50	2,53 €

**FERMASCURI ABS VITE+TASSELLO GIREVOLE NERO**



Cod.	mm	Conf.	Prezzo
063948	70	20	2,34 €

**FERMASCURI ABS VITE+TASSELLO+ AMMORTIZZATORE NERO**



Cod.	mm	Conf.	Prezzo
063949	70	25	4,80 €
063950	120	25	5,44 €

**FERMASCURI METALLO VITE+ TASSELLO NERO**



Cod.	mm	Conf.	Prezzo
063951	60	25	3,84 €

**FERMASCURI METALLO VITE+ TASSELLO REGOLABILE NERO**



Cod.	mm	Conf.	Prezzo
063952	60	40	5,07 €
063953	180	40	5,40 €

**FERMASCURI METALLO VITE+ TASSELLO REGOLABILE NERO**



Cod.	Descrizione	Conf.	Prezzo
063954	pendolo	40	5,28 €

**FERMASCURI METALLO A SCATTO NERO**



Cod.	Descrizione	Conf.	Prezzo
063955	a scatto	25	7,25 €

**DISTANZIALE ABS PER FERMASCURI A SCATTO**



Cod.	Descrizione	Conf.	Prezzo
063956	nero	100	0,86 €

**FERMAFINESTRA ABS NERO**



Cod.	Descrizione	Conf.	Prezzo
063957	in abs	10	3,80 €

**FERMASCURI MAGNETICI**

Completi di 4 viti.



Cod.	mm	Pz	Conf.	Prezzo
131592	28x68	2	20	13,25 €

**CERNIERA PAUMELLES  
DESTRA/SINISTRA**



Cod.	Descrizione	mm	Conf.	Prezzo
050981	destra	80	12	1,57 €
050983	destra	110	12	2,22 €
050985	destra	140	12	3,39 €
050980	sinistra	80	12	1,57 €
050982	sinistra	110	12	2,22 €
050984	sinistra	140	12	3,39 €

**ASA VERNICIATA NERA**



Cod.	mm	Conf.	Prezzo
SI1130.12	120	12	1,52 €
SI1131.14	140	12	1,57 €
SI1132.16	160	12	1,61 €
SI1133.18	180	12	1,73 €
SI1134.20	200	12	1,88 €
SI1135.22	220	12	1,95 €
SI1136.24	240	12	2,08 €
SI1137.26	260	12	2,57 €
SI1138.28	280	12	2,68 €
SI1139.30	300	12	2,67 €

**CERNIERA 330 LUNGA ZINCATA**



Cod.	mm	Conf.	Prezzo
8670000.060	22x60x1,0	24	0,88 €
8670000.080	23x80x1,0	24	1,03 €
8670000.100	26x100x1,3	24	1,20 €
8670000.120	26x120x1,3	24	1,37 €
8670000.130	30x130x1,5	24	1,54 €
8670000.150	30x150x1,6	24	1,70 €

**CERNIERA 317 QUADRA ZINCATA**



Cod.	mm	Conf.	Prezzo
8670005.030	30x30x0,9	24	0,65 €
8670005.040	40x40x0,9	24	0,73 €
8670005.050	50x50x0,9	24	0,82 €
8670005.063	63x63x0,9	24	0,97 €
8670005.070	70x70x1,0	24	1,20 €
8670005.080	80x80x1,2	24	1,45 €
8670005.090	90x90x1,0	24	2,05 €
8670005.100	100x100x1,2	24	2,28 €

**CERNIERA 323 STRETTA ZINCATA**



Cod.	mm	Conf.	Prezzo
8670010.020	20x15x0,7	120	0,45 €
8670010.025	25x20x0,8	24	0,60 €
8670010.030	30x22x0,9	24	0,63 €
8670010.040	40x29x0,9	24	0,69 €
8670010.050	50x30x0,9	24	0,74 €
8670010.063	63x35x0,9	24	0,91 €
8670010.070	70x40x1,0	24	1,01 €
8670010.080	80x45x1,2	24	1,15 €

**CERNIERA 840 ZINCATA  
P/LEV. PESANTE**



Cod.	mm	Conf.	Prezzo
8670015.4035	40x35x1,2	24	0,92 €
8670015.5040	50x40x1,3	24	1,03 €
8670015.6345	63x45x1,3	24	1,23 €
8670015.7550	75x50x1,3	24	1,55 €
8670015.8655	86x55x1,5	24	2,17 €
8670015.10070	100x70x1,6	24	2,79 €

**CERNIERA 804 ZINCATA  
P/LEV. EXTRA PESANTE**



Cod.	mm	Conf.	Prezzo
8670020.5050	50x50x1,6	24	1,52 €
8670020.6565	65x65x2,0	24	2,34 €
8670020.7565	75x65x2,0	24	3,06 €
8670020.7575	75x75x2,0	24	3,27 €
8670020.9075	90x75x2,5	12	4,26 €
8670020.9090	90x90x2,5	12	4,44 €
8670020.10010	100x100x2,5	12	6,11 €
8670020.10090	100x90x2,5	12	5,65 €

## CERNIERA 3322 QUADRA INOX 18/8



Cod.	mm	Conf.	Prezzo
8670035.3022	30x22x0,8	24	1,26 €
8670035.3030	30x30x0,8	24	1,29 €
8670035.4035	40x35x0,8	24	1,86 €
8670035.5040	50x40x0,8	24	2,05 €
8670035.6050	60x50x1,0	24	2,59 €

## CERNIERA 215 A METRO



Cod.	Descrizione	Dimensioni	Conf.	Prezzo
8670030.BRUN	brunita	32 mm x 0,7 mm x 2 m	25	24,20 €
8670030.INOX	inox	32 mm x 0,7 mm x 2 m	25	24,20 €
8670030.OTTO	ottonata	32 mm x 0,7 mm x 2 m	25	6,91 €

## CERNIERA FRESATA PIANA

In ottone.



Cod.	mm	Descrizione	Conf.	Prezzo
8670025.3030	30x30	ottone lucido	24	0,86 €
8670025.3535	35x35	ottone lucido	24	0,97 €
8670025.4035	40x35	ottone lucido	24	1,01 €
8670025.4040	40x40	ottone lucido	24	1,20 €
8670025.5040	50x40	ottone lucido	24	1,45 €
8670025.6050	60x50	ottone lucido	24	1,98 €
8670025.7055	70x55	ottone lucido	24	2,31 €

## CERNIERA SNODI MULTIPLI FZ



Cod.	Descrizione	Conf.	Prezzo
062866	snodo multiplo	1	1,04 €

## CERNIERA C95 110° FN

Con basetta.



Cod.	Descrizione	Conf.	Prezzo
062867	collo dritto	1	0,72 €
062868	mezzo collo	1	0,72 €

## CHIUSURA LEVA ZINCATA REGOLABILE



Cod.	mm	Conf.	Prezzo
SI1525	92-28	25	2,02 €

## TUBO OVALE PER ARMADIO



Cod.	Misura	m	Conf.	Prezzo
062869	30x15	2	1	4,76 €

## CRICCHETTO DUE SFERE



Cod.	mm	Descrizione	Conf.	Prezzo
868311.44	8x44	ottone lucido	50	1,63 €
868311.49	9x49	ottone lucido	50	1,88 €
868311.60	11x60	ottone lucido	50	2,61 €

## PINZETTA BLOCCA PORTA

In zama ottonato. Con incontro ad avvitare.



Cod.	Descrizione	Conf.	Prezzo
879261.000	ottonato	50	2,77 €

## CRICCHETTO SOPRALUCE



Cod.	Descrizione	Conf.	Prezzo
868365L	ottone lucido	30	3,27 €

## INCONTRO PER CRICCHETTO



Cod.	Descrizione	Conf.	Prezzo
868365LA	ottone lucido	30	1,09 €

## GANCIO SICUREZZA



Cod.	Descrizione	Conf.	Prezzo
868370L	ottone lucido	12	7,36 €

## SUPPORTO CORRIMANO PIATTO



Cod.	Descrizione	Conf.	Prezzo
868378B	ottone bronzato	12	9,57 €
868378L	ottone lucidato	12	9,57 €

## SUPPORTO CORRIMANO TONDO



Cod.	Descrizione	Conf.	Prezzo
868379CS	ottone cromato sati.	12	10,35 €
868379L	ottone lucido	12	9,57 €

## MANETTINA SCANALATA



Cod.	mm	Descrizione	Conf.	Prezzo
868380L	140	ottone lucido	30	3,95 €

## TAVELLINO ALLA ROMANA

Spessore chiusura 20 mm.



Cod.	mm	Descrizione	Conf.	Prezzo
868392L.20	50x17	ottone lucido	50	2,90 €

## POMOLO SFERA



Cod.	Ø mm	Descrizione	Conf.	Prezzo
868700CS.22	22	ottone cromato sati.	50	3,51 €
868700CS.26	26	ottone cromato sati.	30	4,59 €
868700CS.30	30	ottone cromato sati.	30	6,26 €
868700L.22	22	ottone lucido	50	2,91 €
868700L.26	26	ottone lucido	30	3,88 €
868700L.30	30	ottone lucido	30	5,52 €

## POMOLO A SFERA



Cod.	Ø mm	Descrizione	Conf.	Prezzo
868710CS.20	20	ottone cromato sati.	50	2,95 €
868710CS.25	25	ottone cromato sati.	30	4,29 €
868710L.20	20	ottone lucido	50	2,35 €
868710L.25	25	ottone lucido	30	3,62 €

## POMOLO TONDO



Cod.	Ø mm	Descrizione	Conf.	Prezzo
868715CS.20	20	ottone cromato sati.	50	2,84 €
868715CS.25	25	ottone cromato sati.	30	3,77 €
868715L.20	20	ottone lucido	50	2,31 €
868715L.25	25	cromato lucido	30	3,13 €

## POMOLO CONICO



Cod.	Ø mm	Descrizione	Conf.	Prezzo
868755CS.17	17	ottone cromato sati.	50	2,43 €
868755L.17	17	ottone lucido	50	1,90 €

## CERNIERA A BISCOTTO

Senza fermo.



Cod.	mm	Descrizione	Conf.	Prezzo
8690131.38N	30x80	ottone nichelato	24	3,22 €
8690131.38S	30x80	ottone satinato	24	2,64 €

## CERNIERA A SCOMPARSA



Cod.	mm	Descrizione	Conf.	Prezzo
8690200.10	10	ottone lucido	24	3,84 €
8690200.12	12	ottone lucido	24	3,84 €
8690200.14	14	ottone lucido	24	4,07 €

## CATENACCILO SAGOMATO

Base 31 mm.



Cod.	mm	Descrizione	Conf.	Prezzo
879058.060	60	ottone lucido	25	3,16 €
879058.080	80	ottone lucido	25	3,61 €
879058.100	100	ottone lucido	25	4,10 €
879058.120	120	ottone lucido	25	5,49 €

## CATENACCILO CANNONE

Base 40 cm.



Cod.	mm	Descrizione	Conf.	Prezzo
879060.060	60	ottone lucido	24	6,57 €
879060.080	80	ottone lucido	24	7,94 €
879060.100	100	ottone lucido	25	10,15 €
879060.120	120	ottone lucido	24	11,50 €

## CATENACCILO A BINARIO



Cod.	mm	Descrizione	Conf.	Prezzo
879052.060	60	ottone lucido	50	1,64 €
879052.080	80	ottone lucido	50	1,87 €
879052.090	90	ottone lucido	50	1,98 €
879052.100	100	ottone lucido	50	2,43 €

## CATENACCIO A CANNONE

Catenaccio a cannone per mobili, capanni, rispostigli, etc., con chiavistello, facile da adattare. Robusto e stabile su qualsiasi porta.



Cod.	mm	Descrizione	Conf.	Prezzo
063236	60	zincato bianco	25	0,57 €
063237	80	zincato bianco	25	0,60 €
063238	100	zincato bianco	25	0,65 €
063239	120	zincato bianco	25	0,70 €
063240	140	zincato bianco	25	0,81 €

## CATENACCIO A CANNONE

Catenaccio a cannone per mobili, capanni, rispostigli, etc., con chiavistello, facile da adattare. Robusto e stabile su qualsiasi porta.



Cod.	mm	Descrizione	Conf.	Prezzo
063241	60	zincato nero	25	0,64 €
063242	80	zincato nero	25	0,68 €
063243	100	zincato nero	25	0,73 €
063244	120	zincato nero	25	0,79 €
063245	140	zincato nero	25	0,91 €

## PORTALUCCHETTO

Portalucchetto in acciaio zincato spessore 2 mm, facile da installare con svasatura per viti.



Cod.	mm	Descrizione	Conf.	Prezzo
063246	45	piccolo	200	0,17 €
063247	55	grande	200	0,22 €

## CATENACCIO TONDO CON PORTALUCCHETTO



Cod.	mm	Descrizione	Conf.	Prezzo
879015.070N	70	nero	10	3,53 €
879015.110N	110	nero	10	4,93 €
879015.150N	150	nero	10	5,25 €
879015.070	70	acciaio bronzato	10	2,59 €
879015.110	110	acciaio bronzato	10	3,68 €
879015.150	150	acciaio bronzato	10	3,68 €

### CATENACCIO PROFILATO DA AVVITARE CON PUNTA ROTONDA

In acciaio verniciato plastificato nero.



Cod.	mm	Conf.	Prezzo
879011A.150	150	15	4,38 €
879011A.200	200	15	4,91 €
879011A.250	250	15	5,92 €
879011A.300	300	15	5,97 €

### CATENACCIO TIPO MIGNON

In acciaio zincato.



Cod.	mm	Conf.	Prezzo
879014.000	80	10	2,19 €

### CATENACCIO ROTONDO CON PORTALUCCHETTO

In acciaio bronzato.



Cod.	mm	Descrizione	Conf.	Prezzo
879063.150N	150	nero	10	7,16 €
879063.200N	200	nero	10	7,59 €
879063.150	150	acciaio bronzato	10	4,82 €
879063.200	200	acciaio bronzato	10	5,24 €

### CATENACCIO CON PORTALUCCHETTO

In acciaio tropicalizzato.

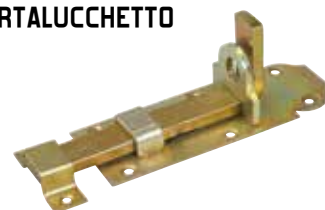

Cod.	mm	Conf.	Prezzo
879019.120	120	10	5,45 €
879019.140	140	10	6,27 €

### CATENACCIO A CANNONE

In acciaio zincato.



Cod.	mm	Conf.	Prezzo
879007.060	60	24	0,60 €
879007.080	80	24	0,68 €
879007.100	100	24	0,76 €
879007.120	120	24	0,86 €
879007.140	140	24	0,94 €

### CATENACCIO RUSTICO CON PUNTA TONDA

In ferro verniciato nero.



Cod.	mm	Conf.	Prezzo
879044.200	200	5	10,45 €
879044.300	300	5	11,55 €
879044.400	400	5	11,75 €

### CATENACCIO VERTICALE DA SALDARE PESANTE

In acciaio zincato. Contropiasta a richiesta.



Cod.	mm	Conf.	Prezzo
879013.200	200	5	7,73 €
879013.250	250	5	8,11 €
879013.300	300	5	9,34 €

### CATENACCIO TRASVERSALE COMPLETO DI CONTROPIASTRA



Cod.	mm	Descrizione	Conf.	Prezzo
879030.080N	80	nero	10	5,03 €
879030.120N	120	nero	10	5,49 €
879030.160N	160	nero	10	5,98 €
879030.200N	200	nero	10	6,51 €

879030.080	80	acciaio bronzato	10	3,59 €
879030.120	120	acciaio bronzato	10	4,07 €
879030.160	160	acciaio bronzato	10	4,55 €
879030.200	200	acciaio bronzato	10	5,19 €



## CATENACCIO PORTALUCCHETTO PROFILATO CON CONTROPIASTRA

In acciaio zincato.



Cod.	mm	Conf.	Prezzo
879036.100	100	10	2,80 €
879036.150	150	10	3,44 €
879036.180	180	10	4,39 €
879036.230	230	10	5,39 €

## CATENACCIO PORTALUCCHETTO PESANTE CON COPRIPIASTRA

In acciaio zincato.



Cod.	mm	Conf.	Prezzo
879038.200	200	5	11,75 €
879038.300	300	5	14,75 €

## CATENACCIO RUSTICO CON PUNTA TONDA

In ferro verniciato nero.



Cod.	mm	Conf.	Prezzo
879043.200	200	5	10,15 €
879043.300	300	5	10,15 €
879043.400	400	5	12,40 €

## CATENACCIO RUSTICO CON PUNTA TONDA

In ferro verniciato nero.



Cod.	mm	Conf.	Prezzo
879045.200	200	5	11,90 €
879045.300	300	5	12,80 €
879045.400	400	5	12,85 €

## CATENACCIO ROTONDO CONTROPIASTRA A RICHIESTA

In bronzo verniciato.



Cod.	mm	Conf.	Prezzo
879064.200	200	10	6,26 €
879064.250	250	10	6,64 €
879064.300	300	10	8,12 €

## CATENACCIO CON PORTALUCCHETTO

In acciaio tropicalizzato.



Cod.	mm	Conf.	Prezzo
879127.200	200	12	4,73 €
879127.300	300	12	7,04 €
879127.400	400	12	8,15 €

## OCCHIOLO PER CATENACCIO

In acciaio tropicalizzato.



Cod.	mm	Conf.	Prezzo
022466	12	100	0,56 €
022467	14	100	0,56 €

## VOLANTINO PLASTICA M5 PASSANTE



Cod.	Misura	Attacco	Conf.	Prezzo
120775	M5	F	25	1,70 €
120776	M6	F	25	2,40 €
120777	M8	F	25	2,99 €
120778	M10	F	10	5,65 €
120779	M12	F	10	6,97 €

## VOLANTINO TERMOPLASTICA



Cod.	Misura	Attacco	Conf.	Prezzo
120749	M5	F	25	2,22 €
120750	M6	F	25	2,26 €
120751	M8	F	25	2,99 €
120752	M10	F	10	3,80 €
120753	M12	F	10	6,13 €

## VOLANTINO TERMOPLASTICA



Cod.	Misura	Attacco	Conf.	Prezzo
120755	M5x15 mm	M	25	2,00 €
120756	M6x30 mm	M	25	2,14 €
120760	M8x40 mm	M	10	3,03 €
120762	M10x40 mm	M	10	3,25 €
120765	M12x50 mm	M	10	5,46 €

## IMPUGNATURA LATERALE



Cod.	Misura	Conf.	Prezzo
120770	M8x15 mm	25	7,14 €
120771	M10x15 mm	25	8,16 €

## CHIUDIPIORTA A MOLLA

In alluminio verniciato argento.



Cod.	Portata kg	Conf.	Prezzo
879088.000	40	24	15,00 €

## MOLLA DA PORTA TIPO TRIUMPH

In acciaio zincato, pomolocilindrico.



Cod.	Portata kg	Conf.	Prezzo
879091.001	25	4	9,94 €
879091.002	40	4	12,10 €
879091.003	60	4	14,35 €

## CHIUDIPIORTA CON ARRESTO



Adatti all'applicazione sia su porte in legno che su porte in metallo. Braccio in acciaio regolabile 80 mm. Peso 45-85 kg. Dimensioni 186x44,5x67 mm.



Cod.	Descrizione	Conf.	Prezzo
129952	grigio	1	56,60 €

## CHIUDIPIORTA ENTRY CON ARRESTO



Installabile su qualunque porta con peso massimo di 85 kg e larghezza 950 mm. Braccio a compasso, velocità di chiusura regolabile, colpo finale, chiusura silenziosa.



Cod.	Descrizione	Conf.	Prezzo
090930	nero RAL9005	1	53,70 €

## CHIUDIPIORTA DESIGN CON ARRESTO



Installabile su qualunque porta con peso massimo di 100 kg e larghezza 1.100 mm. Braccio a compasso, velocità di chiusura regolabile, colpo finale, chiusura silenziosa.



Cod.	Descrizione	Conf.	Prezzo
090931	nero RAL9005	1	79,30 €

## CERNIEREA A MOLLA TIPO BOMMER

In acciaio. Ad azione doppia.



Cod.	mm	Descrizione	Conf.	Prezzo
879107.029	75	nichelato	1	18,05 €
879107.030	100	nichelato	1	21,20 €

## FERMAPORTA A PEDALE VERNICIATO



Cod.	Tipo	Colore	Conf.	Prezzo
879241.000	piccolo	nero	6	5,81 €
879243.000	piccolo	oro	6	5,81 €
879244.000	grande	nero	6	9,70 €
879246.000	grande	oro	6	9,70 €

## PALETTO A LEVA AZIONE SEMPLICE LEVA OTTONE

In acciaio zincato con leva ottone.



Cod.	mm	Conf.	Prezzo
879421.024	24	10	4,26 €

## SERRATURA A CILINDRO Ø 19 MM

Finitura cromata.



Cod.	mm	Conf.	Prezzo
879150.016	16	25	3,84 €
879150.020	20	25	4,11 €
879150.025	25	25	4,57 €
879150.030	30	25	4,90 €

## PALETTO A LEVA A DOPPIA AZIONE PER SERRAMENTI IN METALLO

In acciaio zincato con leva ottone.



Cod.	Descrizione	Conf.	Prezzo
879422	acciaio zincato	10	7,88 €

## CHIAVE PER TAVELLINO TRIANGOLARE



Cod.	Descrizione	Conf.	Prezzo
879154/A	in plastica	50	0,67 €

## CARIGLIONE A DOPPIA AZIONE PER SERRAMENTI METALLICI TIPO PICCOLO

Verniciato nero.



Cod.	Descrizione	Conf.	Prezzo
879429.000	verniciato nero	10	18,30 €

## SERRATURA A CILINDRO



Cod.	Descrizione	Conf.	Prezzo
879154	finitura cromata	25	5,19 €

## CRICCHETTO PER SOPRALUCI DA SALDARE

In acciaio naturale. Scrocco tropicalizzato.



Cod.	Descrizione	Conf.	Prezzo
879412G	tipo grande	25	3,00 €

## PALETTO A LEVA PER SERRAMENTI IN METALLO

In acciaio zincato.



Cod.	mm	Conf.	Prezzo
879420.024	24	10	2,24 €

## CRICCHETTO PER SOPRALUCI DA SALDARE

Tipo medio. In acciaio naturale. Scrocco tropicalizzato.



Cod.	mm	Conf.	Prezzo
879412	53	25	1,75 €

### CERNIERA DA SALDARE A 2 ALI PERNO SFILABILE

Perno a ranella in acciaio zincato.  
Ali acciaio lucido.



Cod.	Ø mm	Capacità kg	Conf.	Prezzo
879401.060	60	40	24	0,69 €
879401.080	80	50	24	1,07 €
879401.100	100	70	24	1,07 €
879401.120	120	90	24	1,48 €
879401.140	140	90	24	1,88 €
879401.170	170	100	12	2,90 €
879401.200	200	120	12	4,32 €

### CERNIERA DA SALDARE A 3 ALI PERNO SFILABILE

Perno e ranella in acciaio zincato.  
Ali acciaio lucido.



Cod.	Ø mm	Capacità kg	Conf.	Prezzo
879402.080	80	70	24	0,96 €
879402.100	100	90	24	1,22 €
879402.120	120	100	24	1,63 €
879402.140	140	100	24	1,99 €
879402.170	170	120	12	3,10 €
879402.200	200	140	12	3,28 €

### CERNIERA PER CANCELLI A 2 ALI APERTE PERNO SFILABILE

Con ranella in ottone.



Cod.	Descrizione	mm	Conf.	Prezzo
879403A.090	ranella in ottone	90	8	6,28 €
879404A.090	cuscinetto a sfere	90	8	7,53 €

### CERNIERA PER CANCELLI A 3 ALI APERTE

Perno sfilabile. Con cuscinetto a sfere.



Cod.	mm	Conf.	Prezzo
879406A.180	180	4	13,90 €

### CERNIERA A GOCCIA GIGANTE REGOLABILE



Cod.	mm	Capacità kg	Conf.	Prezzo
879415R.150	150	100	12	12,65 €

### CERNIERA CON COSTA DA SALDARE PERNO FISSO

Con perno fisso ferro ottonato e ranella in ottone.



Cod.	Ø mm	Capacità kg	Conf.	Prezzo
879414A.080	80	40	24	1,60 €
879414A.100	100	50	24	2,08 €

### CERNIERA CON COSTA DA SALDARE PERNO FISSO

Con perno in ottone e ranella in ottone.



Cod.	Ø mm	Capacità kg	Conf.	Prezzo
8794140.060	60	20	24	1,45 €
8794140.080	80	40	24	1,78 €
8794140.100	100	50	24	2,33 €
8794140.120	120	24	24	3,38 €
8794140.140	140	60	24	3,55 €
8794140.160	160	80	24	6,25 €
8794140.180	180	100	24	9,54 €

### CERNIERA A GOCCIA GIGANTE PER PORTE BLINDATE

Con perno in ottone e cuscinetto a sfere.



Cod.	mm	Capacità kg	Conf.	Prezzo
8794150C.150	150	100	12	4,44 €

### CERNIERA TIPO FICHES DA SALDARE ALA MEDIA

In acciaio naturale.



Cod.	mm	Sezione	Conf.	Prezzo
879495D.060	60	destra	20	1,83 €
879495D.080	80	destra	20	1,74 €
879495D.100	100	destra	10	2,59 €
879495D.120	120	destra	10	3,17 €
879495D.140	140	destra	10	3,68 €
879495S.060	60	sinistra	20	1,83 €
879495S.080	80	sinistra	10	1,90 €
879495S.100	100	sinistra	10	2,59 €
879495S.120	120	sinistra	10	2,90 €
879495S.140	140	sinistra	10	4,03 €

## COPRIPILASTRO TIPO QUADRATO MOD. 398



In ferro zincato.

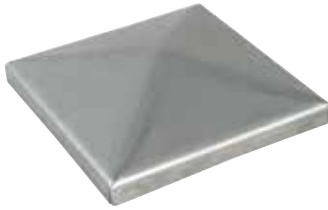

Cod.	mm	Conf.	Prezzo
879398Z.080	80	50	1,05 €
879398Z.100	100	40	1,47 €
879398Z.120	120	50	1,89 €

## CARDINE REGOLABILE CON PIASTRA E VITE



In acciaio zincato.



Cod.	mm	Capacità kg	Conf.	Prezzo
879425VP016	16	60	10	10,20 €
879425VP018	18	80	5	12,00 €
879425VP020	20	100	10	18,20 €
879425VP024	24	150	5	25,50 €

## BATTENTE DI ARRESTO



In acciaio zincato.



Cod.	Descrizione	Conf.	Prezzo
879470.000	acciaio zincato	16	6,32 €

## CARDINE A CUSCINETTI CON REGOLAZIONE A VITE



In acciaio zincato.



Cod.	Ø mm	Capacità kg	Descrizione	Conf.	Prezzo
879838.050	50	500	superiore	1	22,15 €
879839.050	50	500	inferiore	1	21,50 €

## MANIGLIA DA BAULE NERA



Cod.	mm	Conf.	Prezzo
063704	90	1	1,77 €
063705	110	1	2,06 €

## CARDINE A CUSCINETTI CON REGOLAZIONE A VITE



In acciaio zincato.



Cod.	Ø mm	Capacità kg	Descrizione	Conf.	Prezzo
879848.070	70	1000	superiore	1	30,80 €
879849.070	70	1000	inferiore	1	29,75 €

## MANIGLIA IN RESINA CON MOLLA



Colore nero.



Cod.	Descrizione	Conf.	Prezzo
879536.000	in resina - nero	10	8,22 €

## CARDINE REGOLABILE CON RANELLA E DADO



In acciaio zincato.



Cod.	mm	Capacità kg	Conf.	Prezzo
879425R.016	16	60	10	6,66 €
879425R.018	18	80	10	7,70 €
879425R.020	20	100	10	8,43 €
879425R.022	22	100	5	16,35 €

## MANIGLIA PER PORTE METALLICHE CON VITE



Cod.	Descrizione	mm	Conf.	Prezzo
879435.025	verniciata nera	25-38	15	4,05 €
879436.025	cromata	25-38	15	7,13 €

### MANIGLIA PER PORTONI SCORREVOLI



Tipo diritto. In acciaio verniciato nero.



Cod.	mm	Conf.	Prezzo
879482.180	180	10	6,29 €
879482.230	230	10	6,71 €

### MANIGLIA PER PORTONI SCORREVOLI



Tipo piegato. In acciaio verniciato nero.



Cod.	mm	Conf.	Prezzo
879483.180	180	10	7,30 €
879483.230	230	10	7,72 €

### PIASTRA DI GUIDA REGOLABILE A 4 RULLI TIPO PICCOLA PER CANCELLI



In acciaio zincato. Con guide in nylon.



Cod.	mm	Conf.	Prezzo
879465.000	45-70	1	26,95 €

### RULLO DI GUIDA IN NYLON PER CANCELLI SCORREVOLI



In ferro zincato.



Cod.	mm	Conf.	Prezzo
879460.025	25	10	2,82 €
879460.030	30	10	3,01 €
879460.4240	42x40	10	3,44 €
879460.4260	42x60	10	3,81 €

### SICUREZZA ANTICADUTA PER CANCELLI A BATTENTE



Acciaio zincato.



Cod.	L mm	Ø mm	Conf.	Prezzo
879540.500	500	6	1	10,20 €
879540.600	600	6	1	13,60 €
879540.700	700	6	1	14,30 €

### SERRATURA A GANCIO PER CANCELLI SCORREVOLI



Acciaio zincato.



Cod.	Descrizione	Conf.	Prezzo
879447.000	acciaio zincato	1	20,20 €

### CARRELLO PER PORTONI SCORREVOLI



In acciaio. Carrello fisso a 2 cuscinetti. La portata si intende per coppie di carrelli interasse dei supporti 700 mm.



Cod.	Ø mm	AxBxCx(M) mm	Portata kg	Conf.	Prezzo
879330.024	24	63x35x20x(8)	60	40	5,81 €
879330.044	44	110x58x23x(12)	200	10	10,60 €
879330.054	54	152x85x31x(20)	400	10	17,60 €

### CARRELLO IN LAMIERA PER PORTONI SCORREVOLI



In acciaio zincato. Carrello a 4 cuscinetti.



Cod.	Ø mm	Conf.	Prezzo
879338.4	25	10	8,06 €

## CARRELLO PER PORTONI SCORREVOLI



In acciaio. Carrello fisso a 4 cuscinetti.

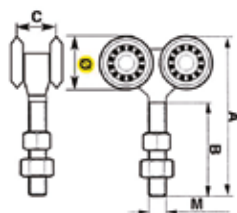

Cod.	Ø mm	AxBxCx(M) mm	Portata kg	Conf.	Prezzo
879331.024	24	63x35x20x(8)	85	20	9,63 €
879331.044	42	125x58x23x(12)	450	6	17,35 €
879331.054	54	152x85x31x(20)	750	10	28,00 €

## RUOTA CON PIASTRA GOLA TONDA



In acciaio zincato.  
1 cuscinetto. Gola tonda.



Cod.	Ø mm	AxCxHxD mm	Portata kg	Conf.	Prezzo
879387.080	80	20x33x15x14	300	6	11,40 €
879387.090	90	20x33x20x14	300	4	13,10 €
879387.120	120	20x33x18x14	400	4	17,45 €

## RUOTA PER CANCELLI GOLA A V



In acciaio zincato.  
1 cuscinetto a sfera. Gola a V.

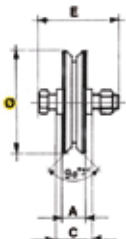

Cod.	Ø mm	AxCx(E) mm	Portata kg	Conf.	Prezzo
879360.060	60	17x24x(10x45)	200	10	7,35 €
879360.080	80	20x33x(14x60)	300	10	8,86 €
879360.100	100	20x33x(14x60)	400	6	11,25 €
879360.120	120	20x33x(14x60)	400	4	13,55 €
879360.140	140	26x44x(16x70)	600	2	21,65 €

## RUOTA CON SUPPORTO INTERNO GOLA A V



In acciaio zincato.  
1 cuscinetto. Gola a V.

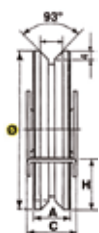

Cod.	Ø mm	AxCxH mm	Portata kg	Conf.	Prezzo
879393.080	80	20x33x25	250	4	11,35 €
879393.090	90	20x33x30	250	4	13,15 €
879393.100	100	20x33x35	300	4	13,80 €
879393.120	120	20x34x39	400	4	17,35 €

## RUOTA PER CANCELLI GOLA TONDA



In acciaio zincato.  
1 cuscinetto a sfera. Gola tonda.

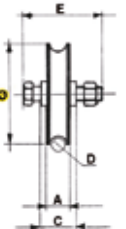

Cod.	Ø mm	AxCx(E)xD mm	Portata kg	Conf.	Prezzo
879361.060	60	17x24x(10x45)x12	200	10	7,88 €
879361.080	80	20x33x(16x60)x14	300	10	9,49 €
879361.100	100	20x33x(14x60)x14	400	6	12,05 €
879361.120	120	20x33x(14x60)x14	400	4	14,55 €
879361.140	140	20x33x(14x60)x14	600	2	23,20 €

## RUOTA CON PIASTRA GOLA A V



In acciaio zincato.  
1 cuscinetto. Gola a V.



Cod.	Ø mm	AxCxH mm	Portata kg	Conf.	Prezzo
879388.080	80	20x33x15	300	6	11,40 €
879388.090	90	20x33x20	300	4	13,10 €
879388.120	120	20x33x18	400	4	17,45 €

## RUOTA CON SUPPORTO INTERNO GOLA TONDA



In acciaio zincato.  
1 cuscinetto.  
Gola tonda.

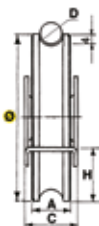

Cod.	Ø mm	AxCxHxD mm	Portata kg	Conf.	Prezzo
879392.080	80	20x33x25x14	250	4	11,35 €
879392.090	90	20x33x30x14	250	4	13,15 €
879392.100	100	20x33x35x14	250	4	13,80 €
879392.120	120	20x34x39x14	250	4	17,35 €

**ARRESTO FINE CORSA  
PER CARRELLI SCORREVOLI**

Tipo piccolo. In acciaio zincato.



Cod.	mm	Conf.	Prezzo
879471PG	50	10	9,93 €

**ARRESTO FINE CORSA DA AVVITARE  
PER CANCELLI SCORREVOLI**

Tipo grande. In acciaio zincato.



Cod.	mm	Conf.	Prezzo
879476G	70	10	15,20 €

**RUOTA PER CAVO BASCULANTE MOD. 368**

In acciaio zincato.



Cod.	Ø mm	Conf.	Prezzo
879368.080	80	10	7,73 €
879368.100	100	6	9,87 €

**RUOTA PER CAVO BASCULANTE MOD. 368/N**

In nylon con cuscinetto.



Cod.	Ø mm	Conf.	Prezzo
879368N.060	60	10	8,00 €
879368N.080	80	10	8,46 €
879368N.100	100	10	9,03 €

**FUNE ACCIAIO ZINCATA  
PER BASCULANTE**

Gancio ad asola.



Cod.	Ø mm	L m	Portata kg	Conf.	Prezzo
1704030E	4	3	900	1	15,00 €

**PARKING STOP MANUALE**

Archetto antisosta ribaltabile e lucchettabile in tubo zincato/verniciato Ø 40 mm.



Bettini

Cod.	L mm	H mm	kg	Conf.	Prezzo
3850020	530	450	3,25	1	38,60 €

**PARKING STOP MANUALE  
CON ASTA DI RINFORZO**

Archetto antisosta ribaltabile lucchettabile e con asta di rinforzo in tubo zincato/verniciato Ø 40 mm.



Bettini

Cod.	L mm	H mm	kg	Conf.	Prezzo
3850022	530	450	4	1	84,40 €

**PORTABICICLETT  
MODULARE 1 POSTO**

Passaruota in tubo da Ø 18 mm.



Bettini

Cod.	cm	Conf.	Prezzo
3850030	33,5x28,5x28,5	1	18,80 €

**PORTABICICLETT  
MODULARE 1 POSTO  
DOPPIA ALTEZZA**

Con passaruota in tubo da Ø 18 cm.



Bettini

Cod.	cm	Conf.	Prezzo
3850032	33,5x36x57	1	32,60 €



## CARRUCOLA LEGA CON GANCIO

Art. 717/30  
Art. 717/40  
Art. 717/50  
Art. 717/60



Cod.	Descrizione	mm	Conf.	Prezzo
012980	Art. 717/30	30	24	1,48 €
000713	Art. 717/40	40	24	1,94 €
000714	Art. 717/50	50	24	2,25 €
000715	Art. 717/60	60	12	3,29 €

## CARRUCOLA NYLON CON GANCIO E CUSCINETTI

Art. 870/50



Cod.	mm	Conf.	Prezzo
024021	50	12	6,81 €

## BULLETTA TAPPEZZIERE BRUNITA

Art. 845/090  
Art. 845/390



Cod.	Descrizione	Pz	Conf.	Prezzo
024031	brunita	1.000	1	61,70 €
024032	ottonata	1.000	1	56,30 €

## RONDELLA ALZAPORTA OTTONE



Cod.	Descrizione	mm	Conf.	Prezzo
024827	Art. 646/08	8	250	0,13 €
024828	Art. 646/09	9	250	0,13 €
024829	Art. 646/10	10	250	0,15 €
024830	Art. 646/11	11	250	0,15 €
024831	Art. 646/12	12	250	0,17 €
024832	Art. 646/13	13	250	0,20 €
024833	Art. 646/14	14	250	0,23 €
024834	Art. 646/15	15	250	0,29 €

## TRECCIA NYLON ALTA TENACITÀ

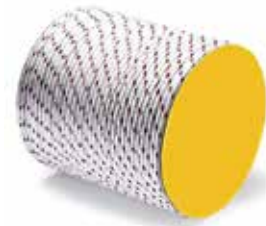

Cod.	mm	m indicativi	Conf.	Prezzo
036064	4	400	1	33,30 €
036065	5	400	1	49,90 €
036066	6	200	1	36,70 €
036067	8	200	1	61,70 €
036068	10	200	1	96,40 €
036069	12	200	1	135,00 €
036070	14	100	1	92,60 €
036071	16	100	1	120,50 €
036227	18	100	1	151,50 €
036228	20	100	1	188,00 €

## CORDA ELASTICA



Cod.	mm	Conf.	Prezzo
039563	6	1	0,49 €
052303	8	1	0,62 €

## GANCIO CORDA ELASTICA IN FERRO



Cod.	Descrizione	Pz	Conf.	Prezzo
039810	plastificati	2	80	0,70 €

## GANCIO PLASTICA CON ANELLI



Cod.	Descrizione	Pz	Conf.	Prezzo
014885	per lacci elastici	2	1	0,87 €

## LACCIO ELASTICO GANCIO IN PLASTICA



Cod.	cm	Pz	Conf.	Prezzo
039806	100	2	20	2,19 €
039807	150	2	20	2,66 €
039808	200	2	20	3,08 €

**LACCIO ELASTICO  
GANCIO IN FERRO**



Cod.	cm	Conf.	Prezzo
841180	80	10	1,87 €
841181	100	10	2,14 €
841182	120	10	2,43 €
841183	150	10	2,74 €
841184	200	10	3,42 €

**CORDA ELASTICA 320 M**



Cod.	mm	m	Conf.	Prezzo
062811	6	320	320	0,56 €

**CORDA ELASTICA 200 M**



Cod.	Colore	mm	Conf.	Prezzo
062812	blu	8	200	0,64 €
062813	rosso	8	200	0,64 €
062814	verde	8	200	0,64 €

**CORDA ELASTICA 100 M**



Cod.	Colore	mm	Conf.	Prezzo
062815	blu	10	100	1,26 €

**GANCIO PVC PER CORDA ELASTICA**

Per corda da 6/8 mm.



Cod.	Pz	Conf.	Prezzo
062816	50	1	11,90 €

**GANCIO PER CORDA ELASTICA**

Per corda elastica Ø 8/10 mm.



Cod.	Descrizione	Pz	Conf.	Prezzo
039811	ferro	2	4	0,81 €

**MORSETTO ZINCATO PER FUNE BLISTER**

con 1 vite a testa esagonale.



Cod.	mm	Pz	Conf.	Prezzo
039812	3	4	5	1,72 €
039813	3,5	4	5	2,01 €

**MORSETTO ZINCATO PER FUNE BLISTER**

Con 2 vite a testa esagonale.



Cod.	mm	Pz	Conf.	Prezzo
039817	3	4	5	4,24 €

**MORSETTO ZINCATO PER FUNE BLISTER**

Con 1 vite laterale esagonale.



Cod.	mm	Pz	Conf.	Prezzo
039819	3	4	5	1,38 €
039820	4	4	5	1,72 €

**MORSETTO ZINCATO PER FUNE BLISTER**

Con 2 viti laterali esagonali.



Cod.	mm	Pz	Conf.	Prezzo
039821	4,5	4	5	4,52 €

**BORCHIA NERA**



Cod.	Ø foro mm	pz	Conf.	Prezzo
062822	15	12	1	5,70 €

## LACCIO IN GOMMA GEAR TIE TWIST 3IN



Adatto per contenere e organizzare cavi di vario tipo. Caratterizzato da un robusto interno in filo flessibile che mantiene la sua forma e dall'esterno in gomma resistente. Riutilizzabile ed impermeabile.



Cod.	Colore	Pz	Conf.	Prezzo
063430	nero	4	12	6,21 €
063462	arancio	4	12	6,21 €
063463	giallo	4	12	6,21 €

## LACCIO IN GOMMA GEAR TIE TWIST 6IN



Adatto per contenere e organizzare cavi di vario tipo. Caratterizzato da un robusto interno in filo flessibile che mantiene la sua forma e dall'esterno in gomma resistente. Riutilizzabile ed impermeabile.



Cod.	Colore	Pz	Conf.	Prezzo
063431	nero	2	12	6,21 €
063464	arancio	2	12	6,21 €
063465	giallo	2	12	6,21 €

## LACCIO IN GOMMA GEAR TIE TWIST 12IN



Adatto per contenere e organizzare cavi di vario tipo. Caratterizzato da un robusto interno in filo flessibile che mantiene la sua forma e dall'esterno in gomma resistente. Riutilizzabile ed impermeabile.



Cod.	Colore	Pz	Conf.	Prezzo
063432	nero	2	6	7,67 €
063466	arancio	2	6	7,67 €
063467	giallo	2	6	7,67 €

## LACCIO IN GOMMA GEAR TIE TWIST 18IN



Adatto per contenere e organizzare cavi di vario tipo di medie e grandi dimensioni. Caratterizzato da un robusto interno in filo flessibile che mantiene la sua forma e dall'esterno in gomma resistente. Riutilizzabile ed impermeabile.



Cod.	Colore	Pz	Conf.	Prezzo
063433	nero	2	6	9,20 €
063468	arancio	2	6	9,20 €
063469	giallo	2	6	9,20 €

## LACCIO IN GOMMA GEAR TIE TWIST 24IN



Organizzatore per avvolgere e appendere oggetti grandi e ingombranti. Caratterizzato da un robusto interno in filo flessibile che mantiene la sua forma e dall'esterno in gomma resistente. Riutilizzabile ed impermeabile.



Cod.	Colore	Pz	Conf.	Prezzo
063434	nero	2	6	9,91 €

## GANCIO AD S PIEGHEVOLE GEAR TIE



Caratterizzato da un esterno aderente in gomma e un interno in filo flessibile che può essere fermato intorno agli oggetti e appeso praticamente ovunque. Impermeabile e resistente ai raggi UV.



Cod.	Colore	Conf.	Prezzo
063435	nero	4	6,45 €

## CINGHIA DI FISSAGGIO CAMJAM TIE DOWN 6FT



Sistema di fissaggio a nastro di alta qualità, dotato di una fibbia a camma da 1" in lega di zinco. Protegge con sicurezza carichi di lavoro fino a 318 kg.



Cod.	m	Conf.	Prezzo
063436	1,83	3	15,35 €

## CINGHIA DI FISSAGGIO CAMJAM TIE DOWN 18FT



Sistema di fissaggio a nastro di alta qualità, dotato di una fibbia a camma da 1" in lega di zinco. Protegge con sicurezza carichi di lavoro fino a 318 kg.



Cod.	m	Conf.	Prezzo
063437	5,48	3	23,00 €

### SERRACAVO ALLUMINIO CAMJAM XT

In alluminio pressofuso e moschettone a meccanismo di bloccaggio a camma. Adatto per fissare, tendere e collegare carichi importanti.

Cod. 063438: limite di carico 127 kg.  
Cod. 063439: limite di carico 227 kg.



Cod.	Modello	Conf.	Prezzo
063438	XT	3	13,85 €
063439	XT large	3	20,75 €

### TENDICORDA PLASTICA CAMJAM

Robusto corpo in plastica combinato con un meccanismo di bloccaggio a camma. Adatto a funi di dimensioni: 2mm - 5mm.



Cod.	Pz	Conf.	Prezzo
063440	4	4	13,80 €

### TENDICORDA PLASTICA CAMJAM + CORDA 8FT

Progettato per bloccarsi saldamente in posizione con una semplice trazione di una corda. Realizzato in plastica robusta e resistente. È dotato di una clip a moschettone con un cancello in acciaio inossidabile su un'estremità e un meccanismo a camma rotante e scanalato sull'altra.



Cod.	Pz	Conf.	Prezzo
063441	2	6	9,71 €

### PORTACHIAVI DOOHICKEY

Multi-strumento cinque in uno. Integrati nel corpo in acciaio inossidabile ci sono un taglierino, un cacciavite a testa piatta, chiavi inglesi, righelli e un apribottiglie.



Cod.	Descrizione	Conf.	Prezzo
063442	acciaio inox	6	6,78 €

### PORTACHIAVI DOOHICKEY CLIPKEY

Multi-strumento in acciaio inossidabile con una testa a cacciavite, un punto di incisione, un bordo seghettato e un apribottiglie. Leggero e resistente.



Cod.	Descrizione	Conf.	Prezzo
063443	acciaio inox	4	6,78 €

### TENDICORDA CON MOSCHETTONE FIGURE 9 LARGE

Tenditore per funi che stringe, mette in tensione e fissa le funi senza utilizzare nodi. Dotato di una clip a moschettone che si attacca a qualsiasi punto di ancoraggio fisso. Adatto a corde da 3-9 mm. Limite di carico 67,5 kg. Colore nero.



Cod.	Descrizione	Conf.	Prezzo
063444	in alluminio	6	8,19 €

### TENDICORDA CON MOSCHETTONE FIGURE 9 SMALL

Tenditore per funi che stringe, mette in tensione e fissa le funi senza utilizzare nodi. Dotato di una clip a moschettone che si attacca a qualsiasi punto di ancoraggio fisso. Adatto a corde da 3-9 mm. Limite di carico 67,5 kg. Colore nero.



Cod.	Descrizione	Conf.	Prezzo
063445	in alluminio	6	5,53 €

### CUSTODIA TORCIA ELETTRICA LITE HOLSTER STRETCH

Struttura robusta per tenere al sicuro le torce di quasi tutte le dimensioni. Con clip durevole che ruota di 360° e si blocca in otto diverse posizioni per un fissaggio versatile e un'illuminazione a mani libere.



Cod.	mm	Conf.	Prezzo
063446	149,34 x 53,33 x 45,16	6	14,05 €

### MOSCHETTONE 2 LEVE S-BINER

Struttura in alluminio. Per fissaggi rapidi e semplici con design a doppia apertura. Dotato di leva di bloccaggio che blocca saldamente entrambi i cancelli con una semplice rotazione.



Cod.	Colore	Pz	Conf.	Prezzo
063447	blu	2	6	6,70 €
063448	rosso	2	6	6,70 €

## MOSCHETTONE 2 LEVE S-BINER

Struttura in acciaio inossidabile, con leva centrale in plastica resistente. Adatto per organizzare oggetti di piccole dimensioni. Dotato di leva a rotazione che si blocca in modo da impedire aperture involontarie.



Cod.	Colore	Pz	Conf.	Prezzo
063449	nero	2	6	6,70 €

## MOSCHETTONE 2 LEVE S-BINER #2

Consente un fissaggio rapido e semplice grazie al suo esclusivo design a doppia apertura con meccanismo SlideLock, che consente di bloccare ogni cancello in modo indipendente. Struttura in alluminio, con cancelli in acciaio. Dimensioni #2: 23 x 50 x 7 mm.



Cod.	Colore	Conf.	Prezzo
063450	arancio	6	5,44 €

## MOSCHETTONE 2 LEVE S-BINER #3

Consente un fissaggio rapido e semplice grazie al suo esclusivo design a doppia apertura con meccanismo SlideLock, che consente di bloccare ogni cancello in modo indipendente. Struttura in alluminio, con cancelli in acciaio. Dimensioni #3: 31 x 69 x 8 mm.



Cod.	Colore	Conf.	Prezzo
063451	blu	6	6,04 €

## MOSCHETTONE ALLUMINIO SLIDELOCK #2

Struttura rettangolare e leggera in alluminio. Dotato di un innovativo meccanismo slide-to-lock sul cancello per mantenere gli oggetti al sicuro.



Cod.	Colore	Conf.	Prezzo
063452	rosso	6	4,55 €

## MOSCHETTONE ALLUMINIO SLIDELOCK #3

Struttura rettangolare e leggera in alluminio. Dotato di un innovativo meccanismo slide-to-lock sul cancello per mantenere gli oggetti al sicuro.



Cod.	Colore	Conf.	Prezzo
063453	blu	6	5,44 €

## MOSCHETTONE PORTACHIAVI SLIDELOCK

Struttura in alluminio. La chiusura e il portachiavi sono uniti da un cinturino in nylon per tenere le chiavi separate. Il moschettone è dotato di un meccanismo SlideLock che blocca il cancello in modo che possa essere fissato con sicurezza.



Cod.	Colore	Conf.	Prezzo
063454	blu	4	6,78 €
063455	verde	4	6,78 €
063456	arancio	4	6,78 €

## CINTURINO ELASTICIZZATO CINCH-A-LOT

Struttura in silicone, aderente ed elastico. Perfetto per attaccare chiavi e altro a oggetti come una bottiglia d'acqua, un telefono o il polso. Il cinturino è abbinato a un resistente moschettone S-Biner di bloccaggio e un anello diviso che presenta un cursore in metallo.



Cod.	Colore	Conf.	Prezzo
063457	blu	4	6,72 €

## PORTACHIAVI CAVATAPPI CON MOSCHETTONE S-BINER

Realizzato in acciaio inossidabile. L'interno del portachiavi è progettato per fungere da pratico apribottiglie e l'altra estremità contiene sei moschettoni S-Biner in plastica di diversi colori.



Cod.	Colore	Conf.	Prezzo
063458	nero	6	8,19 €

## PORTACHIAVI CON MOSCHETTONE S-BINER

Realizzato in acciaio inossidabile. Contiene sei moschettoni S-Biner in plastica di diversi colori.



Cod.	Colore	Conf.	Prezzo
063459	nero	6	6,70 €

### CATENA PLASTICA MARRONE

Per delimitare aree o evidenziare percorsi.



Cod.	Ø mm	m	Conf.	Prezzo
062884	8	25	1	2,23 €

### CATENA PLASTICA BIANCA/ROSSA

Catena spezzoni da 50 cm alternati rossi e bianchi, per delimitare aree o evidenziare percorsi.



Cod.	Ø mm	m	Conf.	Prezzo
000811	6	25	1	1,14 €
031000	8	25	1	1,76 €

### CATENA ZINCATA PER SEGNALAZIONE BIANCA/ROSSA

Catena zincata e verniciata in spezzoni da 50 cm alternati rossi e bianchi, idonea a delimitare aree o evidenziare percorsi.



Cod.	Ø mm	m	Conf.	Prezzo
053510	5	30	1	169,50 €

### PALETTO PVC PER CATENA SEGNALAZIONE



Cod.	Descrizione	Conf.	Prezzo
015845	base da riempire sabbia o acqua	1	9,00 €

### CAPPELOTTO RICAMBIO PER PALETTO SEGNALAZIONE



Cod.	Descrizione	Conf.	Prezzo
015846	rosso - in PVC	1	0,52 €

### CONO STRADALE FLUO BIANCO/ROSSO



Cod.	cm	Conf.	Prezzo
063566	34	1	4,53 €
063567	54	1	9,14 €

### PALETTA STRADALE VERDE/ROSSA



Cod.	cm	Conf.	Prezzo
063570	30	1	13,95 €

### LAMPADA STRADALE INTERMITTENTE



Cod.	Descrizione	Conf.	Prezzo
063568	led giallo	1	14,90 €

### BATTERIA PER LAMPADA STRADALE



Cod.	V	Conf.	Prezzo
063569	6	1	3,71 €

**MENSOLA MURALE PER SPECCHIO PARABOLICO**



Cod.	Descrizione	Conf.	Prezzo
063574	a muro	1	13,95 €

**SPECCHIO STRADALE PARABOLICO CON VISIERA**

La scocca è realizzata in himont mopen ad alta resistenza ai raggi UV. Elevata resistenza all'esterno eliminando completamente problemi di ruggine nel tempo, ottima resistenza al calore, con un bassissimo coefficiente di alterazione del colore, buona resistenza meccanica.



Cod.	cm	Conf.	Prezzo
063571	40	1	54,00 €
063572	50	1	59,60 €
063573	60	1	65,10 €

**NASTRO SEGNALETICO**



Cod.	mm	m	Descrizione	Conf.	Prezzo
NS70200	70	200	bianco/rosso	24	2,93 €

**NASTRO SEGNALETICO**

Nastro in vari colori per la delimitazione delle aree di lavoro. Realizzato in film colorato. Misure: 100 mm x 200 m.



Cod.	Descrizione	Conf.	Prezzo
798200	tubo gas	1	5,99 €
798205	tubo acqua	1	5,99 €
798210	cavo elettrico	1	5,99 €
798215	tubo fogna	1	5,99 €
798220	cavo telefono	1	5,99 €



**Robur**  
ACCESSORI PER FUNI



**ANELLO ZINCATO**



Cod.	Ø interno mm	Pz	Conf.	Prezzo
041739	20	100	1	16,65 €
041740	25	100	1	25,15 €
041741	30	100	1	29,80 €
041742	35	100	1	34,80 €
041743	40	100	1	40,20 €
041744	45	50	1	27,55 €
041745	50	10	1	5,78 €

**GANCIO AD S ZINCATO**



Cod.	mm	Conf.	Prezzo
041732	2,5x15	200	8,70 €
041736	3,0x17	200	9,74 €
041737	3,4x18	200	12,60 €
041738	4,4x20	200	22,20 €
041733	5,5x22	100	17,45 €
041734	6,5x24	50	26,25 €
041735	7,5x26	50	26,45 €

**MOSCHETTONE SICUREZZA ZINCATO**



Cod.	mm	Conf.	Prezzo
022371	40	300	0,37 €
022372	50	150	0,40 €
022373	60	100	0,50 €
022374	70	60	0,54 €
022375	80	40	0,73 €
022376	90	45	1,14 €
022377	100	35	1,32 €
022378	120	20	1,70 €

**MOSCHETTONE COLORATO ALLUMINIO**



Cod.	mm	Conf.	Prezzo
FU-24151	50	1	1,14 €
FU-24152	60	1	1,18 €
FU-24153	70	1	1,15 €
FU-24154	80	1	1,39 €
FU-24155	100	1	1,91 €
FU-24156	120	1	2,51 €

**MOSCHETTONE CON OCCHIO TONDO NICHELATO**



Cod.	mm	Conf.	Prezzo
035214	13x73	500	0,68 €
035215	16x84	500	1,20 €
055295	25x93	400	1,61 €

**GIVOLARE ZINCATO**



Cod.	mm	Conf.	Prezzo
001759	5	10	1,03 €
055291	6	10	1,31 €
001760	7	10	1,74 €
012520	8	10	2,29 €

**MOSCHETTONE SIMPLEX**



Cod.	mm	Conf.	Prezzo
002546	30	100	0,15 €
002547	40	75	0,21 €
002548	50	75	0,30 €
002549	60	50	0,39 €
002550	70	50	0,52 €
002551	80	25	0,68 €
002552	100	25	1,11 €

**MOSCHETTONE PRESSOFUSO**



Cod.	mm	Descrizione	Conf.	Prezzo
002568	10	bronzo nikelato	100	3,78 €
002569	12	bronzo nikelato	100	4,54 €
002570	16	bronzo nikelato	50	5,70 €
002571	21	bronzo nikelato	50	5,86 €
001479	25	bronzo nikelato	25	7,86 €
002561	10	bronzo lucido	100	3,55 €
002562	12	bronzo lucido	100	4,31 €
002563	16	bronzo lucido	50	5,46 €
002564	21	bronzo lucido	50	5,63 €
002565	25	bronzo lucido	25	7,63 €
002566	28	bronzo lucido	25	6,24 €
002567	32	bronzo lucido	20	9,52 €



## MOSCHETTONE AD OCCHIO INOX



Robur

Cod.	mm	Conf.	Prezzo
B8250.50	50	1	2,75 €
B8250.70	70	1	4,13 €

## SPILLONE DI SICUREZZA



Cod.	mm	Conf.	Prezzo
062249	3x60	10	0,98 €
062260	4x100	10	1,24 €
062261	5x90	10	1,35 €

## COPPIGLIA



Cod.	mm	Conf.	Prezzo
005515	2x50	10	0,05 €
005517	3x16	10	0,10 €
005519	4x76	10	0,16 €
005521	5x100	10	0,28 €
011219	6x114	10	0,63 €
011221	8x162	10	1,65 €

## SPINOTTO A SCATTO



Cod.	mm	Conf.	Prezzo
041382	5x48	10	0,28 €
004244	6x55	10	0,33 €
004245	8x54	10	0,47 €
062267	9x55	10	0,50 €
004246	10x56	10	0,50 €
004247	11x56	10	0,60 €

## CATENA GENOVESE INOX 316



Cod.	n°	Ø mm	m	Conf.	Prezzo
127258	17	3	50	1	270,00 €
127260	21	5	40	1	482,50 €
127261	23	6	30	1	518,00 €
127262	27	8	15	1	458,50 €

## CATENA ZINCATA GENOVESE



AREF

Cod.	n°	Ø mm	m	Conf.	Prezzo
FU-2609	12	1,6	150	2	117,00 €
FU-2610	14	2,2	50	2	68,40 €
FU-2615	16	2,7	75	1	88,90 €
FU-2617	17	3,0	75	1	103,00 €
FU-2620	18	3,5	75	1	122,00 €
FU-2622	19	4,0	75	1	135,50 €
FU-2625	20	4,2	50	1	115,50 €
FU-2627	21	5,0	50	1	133,00 €
FU-2630	22	5,5	40	1	127,00 €
FU-2632	23	6,0	30	1	111,50 €
FU-2635	24	6,5	25	1	110,00 €
FU-2637	25	7,0	25	1	122,50 €
FU-2640	26	7,5	20	1	113,00 €
FU-2642	27	8,0	15	1	94,30 €
FU-2645	28	9,0	15	1	123,50 €
FU-2650	30	10,0	10	1	101,00 €
FU-2655	32	12,0	8	1	116,00 €

## CATENA A MAGLIA QUADRA RULLATA



AREF

Cod.	Descrizione	Ø mm	m	Conf.	Prezzo
FU-2617B	bronzata	2,2	30	1	47,20 €
FU-2620B	bronzata	2,7	20	3	34,90 €
FU-2617T	ottonata	2,2	30	1	47,20 €
FU-2620T	ottonata	2,7	20	3	34,90 €

## CATENA PLASTIFICATA



AXEL

Cod.	cm	Descrizione	Conf.	Prezzo
039516	5x60	verde	40	3,07 €
039517	5x80	verde	25	4,01 €
039725	7,5x60	rossa	20	5,91 €
039726	7,5x80	rossa	15	7,67 €
039727	7,5x100	rossa	10	9,50 €
039729	7,5x150	rossa	6	14,25 €

## FALSA MAGLIA ZINCATA



AREF

Cod.	Ø mm	Conf.	Prezzo
FU-2440I	3,5	1000	0,14 €
FU-2445I	4	1000	0,17 €
FU-2450I	5	500	0,27 €
FU-2455I	6	300	0,61 €

**MAGLIA RAPIDA ZINCATA**

Robur



Cod.	mm	Conf.	Prezzo
B8080.4	4x40	100	0,36 €
B8080.6	6x57	100	0,55 €
B8080.8	8x74	50	0,85 €
B8080.10	10x89	25	1,45 €
B8080.12	12x105	20	2,55 €

**MAGLIA RAPIDA INOX**

Robur



Cod.	mm	Conf.	Prezzo
B8280.36	3,5x36	10	2,18 €
B8280.40	4x40	10	2,31 €
B8280.49	5x49	10	2,83 €
B8280.57	6x57	10	3,36 €

**TENDITORE AD OCCHIO E GANCIO ZINCATO**

Robur



Cod.	Ø mm	Conf.	Prezzo
B8006Z.M5	M5	400	1,62 €
B8006Z.M6	M6	250	1,80 €
B8006Z.M8	M8	180	2,79 €
B8006Z.M10	M10	100	4,05 €
B8006Z.M12	M12	50	6,35 €
B8006Z.M14	M14	1	9,39 €
B8006Z.M16	M16	1	14,09 €
B8006Z.M18	M18	1	20,65 €
B8006Z.M20	M20	1	24,70 €
B8006Z.M22	M22	1	31,99 €
B8006Z.M24	M24	1	43,33 €

**TENDITORE A DUE OCCHI ZINCATO**

Robur



Cod.	Ø mm	Conf.	Prezzo
B8005Z.M5	M5	400	1,60 €
B8005Z.M6	M6	300	1,80 €
B8005Z.M8	M8	200	2,75 €
B8005Z.M10	M10	100	3,96 €
B8005Z.M12	M12	60	5,91 €
B8005Z.M14	M14	35	8,18 €
B8005Z.M16	M16	1	12,23 €
B8005Z.M18	M18	1	19,11 €
B8005Z.M20	M20	1	21,06 €
B8005Z.M22	M22	1	27,94 €
B8005Z.M24	M24	1	34,83 €

**TENDITORE A DUE OCCHI INOX**

Robur



Cod.	Ø mm	Conf.	Prezzo
B8205.M5	5	1	4,73 €
B8205.M6	6	1	6,27 €
B8205.M8	8	1	9,72 €
B8205.M10	10	1	14,49 €

**ANELLO PER TENDITORE DESTRO ZINCATO**

Robur



Cod.	Ø mm	Conf.	Prezzo
B8002ZD.M5	5	200	0,33 €
B8002ZD.M6	6	150	0,38 €
B8002ZD.M8	8	100	0,58 €
B8002ZD.M10	10	100	0,94 €
B8002ZD.M12	12	50	1,68 €

**VITE AD OCCHIOLO INOX**

Robur



Cod.	Ø mm	Conf.	Prezzo
B8249.5	5	10	1,71 €
B8249.6	6	10	2,14 €
B8249.8	8	5	3,44 €
B8249.10	10	5	6,19 €
B8249.12	12	1	10,77 €

**GANCIO PER TASSELLO DESTRO ZINCATO**

Robur



Cod.	mm	Conf.	Prezzo
B8303Z.M5	M5x48	150	0,42 €
B8303Z.M6	M6x55	120	0,47 €
B8303Z.M8	M8x60	100	0,77 €
B8303Z.M10	M10x73	70	1,28 €
B8303Z.M12	M12x90	30	2,14 €

**MORSETTO DA CAVI**

MC



Cod.	mm	Conf.	Prezzo
022352	3	350	0,10 €
022353	5	250	0,13 €
022354	6	175	0,15 €
022355	8	100	0,22 €
022356	10	50	0,41 €
022357	12	40	0,70 €
022358	14	40	0,75 €
022359	16	25	1,14 €
022361	20	15	1,38 €

## MORSETTO IN ACCIAIO ZINCATO



**Robur**

Cod.	Ø mm	Conf.	Prezzo
B801603	3	500	0,41 €
B801605	5	300	0,53 €
B801606	6	200	0,58 €
B801608	8	150	0,72 €
B8016010	10	70	1,09 €
B8016011	11	70	1,18 €
B8016013	13	40	1,58 €
B8016014	14	35	1,71 €
B8016016	16	30	2,01 €
B8016018	18	30	2,75 €
B8016020	20	30	2,95 €
B8016022	22	25	3,44 €
B8016026	26	40	4,82 €

## REDANCE INOX



**Robur**

Cod.	Ø mm	Conf.	Prezzo
B8220.3	3	10	0,71 €
B8220.4	4	10	0,81 €
B8220.5	5	10	0,98 €
B8220.6	6	10	1,11 €
B8220.8	8	10	1,75 €

## GRILLO DIRITTO TIPO LARGO FORGIATO ZINCATO

**Robur**



Cod.	Ø mm	Conf.	Prezzo
B802505	5	250	0,98 €
B802506	6	250	1,32 €
B802508	8	150	2,23 €
B8025010	10	180	2,47 €
B8025011	11	130	2,99 €
B8025012	12	100	3,24 €
B8025014	14	70	4,17 €
B8025016	16	50	5,50 €
B8025018	18	35	7,97 €
B8025020	20	30	9,39 €
B8025025	25	15	17,33 €

## MORSETTO INOX



**Robur**

Cod.	Ø mm	Conf.	Prezzo
B8216.3	M3	15	2,01 €
B8216.4	M4	10	2,27 €
B8216.5	M5	10	2,59 €
B8216.6	M6	10	2,87 €
B8216.8	M8	10	3,84 €
B8216.10	M10	5	5,30 €
B8216.13	M13	5	7,45 €

## GRILLO DIRITTO TIPO A FORGIATO ZINCATO

**Robur**



Cod.	Ø mm	Conf.	Prezzo
B8026A.12	12	100	3,07 €
B8026A.14	14	90	3,88 €
B8026A.16	16	60	4,98 €
B8026A.18	18	40	7,04 €
B8026A.20	20	35	8,82 €
B8026A.22	22	20	11,58 €
B8026A.25	25	15	16,52 €

## RADANCE TIPO LEGGERO ZINCATA

**Robur**



Cod.	Ø mm	Conf.	Prezzo
B8020A.3	2-3	350	0,15 €
B8020A.4	4	300	0,16 €
B8020A.5	5	300	0,18 €
B8020A.6	6	200	0,19 €
B8020A.8	8	180	0,30 €
B8020A.10	10	120	0,44 €
B8020A.12	12	160	0,58 €
B8020A.14	14	100	0,75 €
B8020A.16	16	150	1,04 €
B8020A.18	18	100	1,39 €
B8020A.20	20	70	1,93 €

## GRILLO DIRITTO TIPO A INOX

**Robur**



Cod.	Ø mm	Conf.	Prezzo
B8225.4	4	10	2,10 €
B8225.5	5	10	2,31 €
B8225.6	6	10	2,55 €
B8225.8	8	10	4,05 €
B8225.10	10	5	5,87 €
B8225.12	12	5	9,72 €

**GOLFARE MASCHIO ZINCATO**

**Robur**



Cod.	Ø mm	Conf.	Prezzo
B8040Z.M6	M6	60	1,24 €
B8040Z.M8	M8	60	1,24 €
B8040Z.M10	M10	50	1,67 €
B8040Z.M12	M12	25	2,23 €
B8040Z.M14	M14	25	2,91 €
B8040Z.M16	M16	1	3,68 €
B8040Z.M18	M18	1	4,45 €
B8040Z.M20	M20	1	5,67 €
B8040Z.M22	M22	1	7,37 €
B8040Z.M24	M24	1	10,77 €
B8040Z.M27	M27	1	13,28 €
B8040Z.M30	M30	1	22,27 €
B8040Z.M33	M33	1	30,78 €
B8040Z.M36	M36	1	31,99 €
B8040Z.M42	M42	1	59,13 €

**GOLFARE MASCHIO INOX**

**Robur**



Cod.	Ø mm	Conf.	Prezzo
B8240.M6	M6	20	1,37 €
B8240.M8	M8	10	2,05 €
B8240.M10	M10	10	4,09 €
B8240.M12	M12	5	6,96 €

**GOLFARE FEMMINA ZINCATO**

**Robur**



Cod.	Ø mm	Conf.	Prezzo
B8042Z.M6	M6	60	1,24 €
B8042Z.M8	M8	60	1,24 €
B8042Z.M10	M10	50	1,67 €
B8042Z.M12	M12	30	2,31 €
B8042Z.M14	M14	30	2,91 €
B8042Z.M16	M16	1	3,68 €
B8042Z.M18	M18	1	4,45 €
B8042Z.M20	M20	1	5,58 €
B8042Z.M22	M22	1	7,29 €
B8042Z.M24	M24	1	10,77 €
B8042Z.M27	M27	1	12,87 €
B8042Z.M30	M30	1	20,65 €
B8042Z.M36	M36	1	31,59 €
B8042Z.M42	M42	1	57,51 €

**GOLFARE FEMMINA INOX**

**Robur**



Cod.	Ø mm	Conf.	Prezzo
B8242.M6	M6	20	1,37 €
B8242.M8	M8	10	2,05 €
B8242.M10	M10	10	4,09 €
B8242.M12	M12	5	6,96 €

**GANCIO PER SOLLEVAMENTO  
AD OCCHIO ACCIAIO LEGATO  
AD ALTA RESISTENZA**

**Robur**



Cod.	WLL Kg	Conf.	Prezzo
B8052.800	800	1	4,41 €
B8052.1200	1120	1	5,91 €
B8052.2000	2000	1	12,55 €
B8052.3150	3150	1	19,35 €
B8052.4000	4000	1	25,11 €

**GANCIO GIREVOLE IN ACCIAIO  
AL CARBONIO BONIFICATO**

**Robur**



Cod.	WLL Kg	Conf.	Prezzo
B8064S.1000	1000	1	34,02 €
B8064S.1600	1600	1	44,55 €
B8064S.2000	2000	1	49,00 €
B8064S.3200	3200	1	85,05 €



## CINGHIA SOLLEVAMENTO

**Robur**



Cod.	Colore	WLL kg	Lunghezza	Conf.	Prezzo
B8150.1	viola	1000	1 m	1	4,50 €
B8150.2	viola	1000	2 m	1	6,74 €
B8150.3	viola	1000	3 m	1	8,66 €
B8150.4	viola	1000	4 m	1	11,15 €

B8153.1	verde	2000	1 m	1	7,86 €
B8153.2	verde	2000	2 m	1	11,85 €
B8153.3	verde	2000	3 m	1	15,95 €
B8153.4	verde	2000	4 m	1	20,10 €
B8153.5	verde	2000	5 m	1	24,65 €
B8153.6	verde	2000	6 m	1	28,65 €

B8156.1,5	giallo	3000	1,5 m	1	14,05 €
B8156.2	giallo	3000	2 m	1	17,40 €
B8156.3	giallo	3000	3 m	1	23,75 €
B8156.4	giallo	3000	4 m	1	30,00 €
B8156.5	giallo	3000	5 m	1	37,30 €
B8156.6	giallo	3000	6 m	1	44,10 €

## CINGHIA DI ANCORAGGIO A CRICCHETTO INT. AUTOCARRI - LC 1000 KG

**Robur**

- terminale con gancio a innesto rapido
- nastro poliestere (PES)
- larghezza 50 mm



Cod.	L m	Conf.	Prezzo
B8182E.4	4	1	15,75 €

## CINGHIA DI ANCORAGGIO - LC 1000 KG

**Robur**

- terminale con gancio a uncino
- nastro poliestere ad alta tenacità (PES)



Cod.	L m	Conf.	Prezzo
B8181.6000	6	1	14,15 €

## CINGHIA DI LEGATURA CON FIBBIA

**Robur**

- con 29 sistemi di legatura ad anello
- coefficiente di sicurezza 2:1
- etichette di portata con numero di lotto
- dimensioni 33x24x28 cm
- peso 3,1 kg



Cod.	mm x m	Descrizione	Pz	Prezzo
B8188F.1500	25x1,5	con fibbia	10	1,75 €
B8188F.2500	25x2,5	con fibbia	10	2,14 €
B8188F.5000	25x 5,0	con fibbia	6	2,89 €
B8188C	25x5,0	con mini cric.	3	5,02 €
B8188/E29	-	expo completo	29	71,30 €

## CINGHIA DI ANCORAGGIO - LC 2000 KG

**Robur**

- terminale con gancio a uncino
- nastro poliestere ad alta tenacità (PES)



Cod.	L m	Conf.	Prezzo
B8182.6500	6,5	1	21,45 €

## CINGHIA DI ANCORAGGIO A CRICCHETTO LC 750 KG

**Robur**

- terminale con gancio a uncino
- nastro poliestere (PES)
- larghezza 25 mm



Cod.	L m	Conf.	Prezzo
B8180.4000	4	1	11,20 €

## CINGHIA DI ANCORAGGIO A CRICCHETTO LC 2000 KG

**Robur**

- LC - 1000 KG
- terminale con gancio a innesto rapido
- nastro poliestere (PES)
- larghezza 50 mm



Cod.	L m	Conf.	Prezzo
B8182.8000	8,5	1	23,30 €

## RETE ELETTROSALDATA ZINCATA

Rete zincata dopo la saldatura.  
Filo Ø 1,7 mm.



Cod.	Maglia	H cm	m	Conf.	Prezzo
GA5108	50x75	100	25	1	58,70 €
GA5109	50x75	125	25	1	71,30 €
GA5111	50x75	150	25	1	87,00 €
GA5114	50x75	175	25	1	105,50 €
GA5116	50x75	200	25	1	114,50 €

## RETE REPLAX MARGHERITA TL

Rete metallica a semplice torsione a maglia sciolta zincata e plastificata.  
Resistenza 70 kg/mm<sup>2</sup>.  
Colore verde alpi brillante.  
Applicazioni: recinzioni in aree residenziali, industriali, sportive e cantieri edili.



Filo Ø 1,80/2,70 mm.

Cod.	Maglia	H cm	m	Conf.	Prezzo
GPR06100025B	50x50	100	25	1	99,00 €
GPR06125025B	50x50	125	25	1	123,50 €
GPR06150025B	50x50	150	25	1	148,00 €
GPR06175025B	50x50	175	25	1	173,50 €
GPR06200025B	50x50	200	25	1	197,50 €

## RETE ELETTROSALDATA PLASTIFICATA

Filo Ø 1,7/2,2 mm.



Cod.	Maglia	H cm	m	Conf.	Prezzo
GA5101	50x75	100	25	1	75,80 €
GA5103	50x75	125	25	1	93,30 €
GA5104	50x75	150	25	1	113,00 €
GA5106	50x75	175	25	1	123,50 €
GA5107	50x75	200	25	1	137,50 €

## RETE NOVAPLAX

Rete in filo zincato, elettrosaldato e plastificato.  
I fili verticali - lineari - ed orizzontali - sagomati - della rete elettrosaldato sono in acciaio zincato. Colore verde alpi. Applicazione: recinzioni aree industriali e residenziali, spazi verdi e giardini.



Filo Ø 2,20 mm. A maglia differenziata.

Cod.	H cm	m	Conf.	Prezzo
S003060025B	60	25	1	79,70 €
S003080025B	80	25	1	105,50 €
S003100025B	100	25	1	129,00 €
S003120025B	120	25	1	153,50 €
S003150025B	150	25	1	191,00 €
S003180025B	180	25	1	224,00 €
S003200025B	200	25	1	249,00 €

## RETE MARGHERITA ONDULATA



Cod.	Maglia	H cm	m	Conf.	Prezzo
S03010025BM	50x100	100	25	12	95,30 €
S03012025BM	50x100	120	25	12	112,50 €
S03015025BM	50x100	150	25	12	141,50 €
S03018025BM	50x100	180	25	12	171,00 €
S03020025BM	50x100	200	25	12	189,50 €

## RETE DECOPLAX EVOLUZIONE

Elettrosaldato zincato e plastificato a maglie ottagonali ridotte. Fili verticali Ø 2,60 mm e fili orizzontali Ø 2,40 mm.

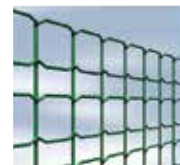

Cod.	Descrizione	H cm	m	Conf.	Prezzo
S010080025B	verde	80	25	1	167,50 €
S010100025B	verde	100	25	1	205,50 €
S010120025B	verde	120	25	1	246,00 €
S010150025B	verde	150	25	1	307,50 €
S010180025B	verde	180	25	1	369,00 €
S010200025B	verde	200	25	1	410,50 €

## PANNELLO PANOPLAX

Filo Ø 4 mm.  
Maglia 200x55.



Cod.	Descrizione	Maglia	H cm	Conf.	Prezzo
GA5639A	antracite	200x55	103	1	32,10 €
GA5640A	antracite	200x55	123	1	34,70 €
GA5641A	antracite	200x55	153	1	43,40 €
GA5642A	antracite	200x55	173	1	47,60 €
GA5639	verde	200x55	103	1	32,10 €
GA5640	verde	200x55	123	1	34,70 €
GA5641	verde	200x55	153	1	43,40 €
GA5642	verde	200x55	173	1	47,60 €

## PALO PALDECO CON PIATTINA



Cod.	Descrizione	Ø cm	H cm	Conf.	Prezzo
GA5644NA	antracite	50x1,2	103	1	21,40 €
GA5645NA	antracite	50x1,2	123	1	24,10 €
GA5646NA	antracite	50x1,2	153	1	29,15 €
GA5647NA	antracite	50x1,2	173	1	32,50 €
GA5644N	verde	50x1,2	103	1	20,75 €
GA5645N	verde	50x1,2	123	1	23,40 €
GA5646N	verde	50x1,2	153	1	28,30 €
GA5647N	verde	45x4,5	173	1	31,60 €

## COLLARE IN PLASTICA E VITE CON TAPPO PANOPLAX

Cod.	Descrizione	Pz	Conf.	Prezzo
GA5650A	antracite	10	1	24,30 €
GA5650	verde	10	1	24,30 €

## CANCELLI PEDONALI

Cancelli in tubolare quadrato e rete elettrosaldata 100x50, plastificati con doppia maglia, serratura reversibile con chiave e 2 pali di sostegno.



Cod.	Altezza	Larghezza	Conf.	Prezzo
VC02100001B	100 cm	100 cm	1	383,50 €
VC02125001B	125 cm	100 cm	1	420,50 €

## RETE ESAPLAX PESANTE 4X4

Filo Ø 1,30 mm.

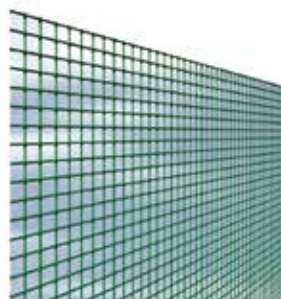

Cod.	Maglia	H cm	m	Conf.	Prezzo
SE02050025B	12,7x12,7	50	25	1	99,90 €
SE02060025B	12,7x12,7	60	25	1	121,00 €
SE02070025B	12,7x12,7	70	25	1	137,00 €
SE02080025B	12,7x12,7	80	25	1	158,00 €
SE02100025B	12,7x12,7	100	25	1	194,50 €
SE02120025B	12,7x12,7	120	25	1	233,50 €
SE02150025B	12,7x12,7	150	25	1	291,00 €
SE02200025B	12,7x12,7	200	25	1	388,50 €

## RETE ESAFORT

Rete in filo zincato, elettrosaldata, zincata dopo la saldatura. I fili verticali ed orizzontali, entrambi lineari, sono in acciaio zincato.

Applicazioni: recinzioni industriali, ferrovie e statali, recinzioni per animali, gabbie e voliere, protezioni per fiori e piante, grate, pannelli in generale.



Cod.	Maglia	H cm	m	Conf.	Prezzo
Ø filo 0,65 mm					
SF01050025B	6,3x6,3	50	25	1	191,50 €
SF01100025B	6,3x6,3	100	25	1	361,50 €
Ø filo 0,80 mm					
SF05100025B	8,3x8,3	100	25	1	347,00 €
Ø filo 1,05 mm					
SF18050025B	12,7x12,7	50	25	1	143,00 €
SF18060025B	12,7x12,7	60	25	1	170,00 €
SF18080025B	12,7x12,7	80	25	1	223,50 €
SF18100025B	12,7x12,7	100	25	1	275,50 €
Ø filo 1,45 mm					
SF43050025B	19x19	50	25	1	163,00 €
SF43080025B	19x19	80	25	1	254,00 €
SF43100025B	19x19	100	25	1	317,00 €
SF43120025B	19x19	120	25	1	382,00 €
Ø filo 1,45 mm					
SF28050025B	12,7x25,4	50	25	1	174,00 €
SF28080025B	12,7x25,4	80	25	1	274,50 €
SF28100025B	12,7x25,4	100	25	1	339,00 €

## RETE TREFORT

Filo Ø 0,70 mm.



CAVATORTA

Cod.	Maglia	H cm	m	Conf.	Prezzo
028397	2x16	50	50	1	97,10 €
026330	2x16	60	50	1	116,00 €
026331	2x16	80	50	1	154,00 €
026226	2x16	100	50	1	189,50 €

## RETE ELETTROSALDATA ZINCATA

Filo Ø 0,65 mm.



AEL  
GREEN

Cod.	Maglia	H cm	m	Conf.	Prezzo
GA5100	6,3x6,3	50	25	1	76,40 €
GA5102	6,3x6,3	60	25	1	95,60 €
GA5110	6,3x6,3	100	25	1	152,80 €

## RETE TRIPLA TORSIONE SALDATA 2/16

Rete zincata dopo la saldatura.  
Filo Ø 0,7 mm esterno.



AEL  
GREEN

Cod.	Maglia	H cm	m	Conf.	Prezzo
GA5535V	16	50	10	1	10,35 €
GA5530V	16	100	10	1	18,95 €
GA5535	16	50	50	1	39,80 €
GA5530	16	60	50	1	47,00 €
GA8264	16	80	50	1	63,70 €
GA8265	16	100	50	1	79,70 €
GA5522	16	150	50	1	118,00 €
GA5523	51	200	50	1	154,00 €

## RETE ELETTROSALDATA ZINCATA

Filo Ø 0,9 mm.



AEL  
GREEN

Cod.	Maglia	H cm	m	Conf.	Prezzo
GA5190	12,5x12,5	50	10	1	22,00 €
GA5195	12,5x12,5	100	10	1	41,80 €
GA5200	12,5x12,5	50	25	1	54,00 €
GA5205	12,5x12,5	60	25	1	67,80 €
GA5210	12,5x12,5	80	25	1	85,50 €
GA5215	12,5x12,5	100	25	1	106,00 €

## RETE TRIPLA TORSIONE SALDATA 4/51

Rete zincata dopo la saldatura.  
Filo Ø 0,9 mm esterno.



AEL  
GREEN

Cod.	Maglia	H cm	L rotolo	Conf.	Prezzo
GA8260V	51	50	10	1	6,00 €
GA8262V	51	100	10	1	10,80 €
GA5498	51	50	50	1	27,80 €
GA8260	51	100	50	1	50,20 €
GA8261	51	120	50	1	59,40 €
GA8262	51	150	50	1	74,40 €
GA8263	51	200	50	1	101,20 €

## RETE ELETTROSALDATA PLASTICATA

Filo Ø 0,9 mm interno - Ø 1,0 mm esterno.



AEL  
GREEN

Cod.	Maglia	H cm	m	Conf.	Prezzo
GA5445	12,5x12,5	50	10	1	19,90 €
GA5448	12,5x12,5	100	10	1	37,20 €
GA5450	12,5x12,5	50	25	1	43,00 €
GA5455	12,5x12,5	60	25	1	55,00 €
GA5460	12,5x12,5	80	25	1	68,90 €
GA5465	12,5x12,5	100	25	1	80,50 €
GA5470	12,5x12,5	125	25	1	96,10 €
GA5475	12,5x12,5	150	25	1	125,00 €



## DISPERSORE CORRENTE

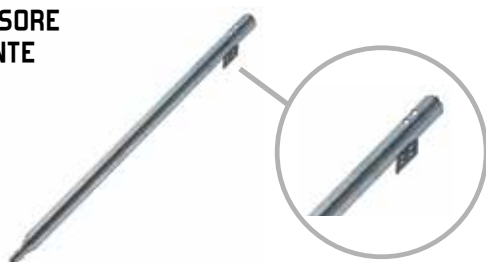

Cod.	Descrizione	Conf.	Prezzo
000648	paletto zincato 150 cm	10	32,10 €
003021	morsetto zincato	1	1,55 €

## SAETTA ZINCATA AD U



Cod.	H cm	cm	Conf.	Prezzo
003017	120	25x25x3	10	7,01 €
003018	150	25x25x3	10	8,77 €
003019	200	25x25x3	10	12,30 €

## PALETTI PLASTIFICATI



Cod.	H cm	mm	Conf.	Prezzo
054345	100	30x30x3,0	10	4,66 €
041395	125	30x30x3,0	10	5,82 €
041396	150	30x30x3,0	10	6,97 €
041397	175	30x30x3,0	10	8,14 €
041398	200	35x35x3,5	10	12,00 €
041399	225	35x35x3,5	10	13,50 €
041400	250	35x35x3,5	10	15,00 €

## SUPPORTO POSA PALETTI T30 SU MURO



Cod.	Descrizione	Conf.	Prezzo
054348	zincato	1	16,35 €
054349	plasticato	1	20,80 €

## PALETTI ZINCATI



Cod.	H cm	mm	Conf.	Prezzo
003010	100	30x30x3,5	10	6,63 €
003011	125	30x30x3,5	10	8,13 €
003012	150	30x30x3,5	10	9,84 €
003013	175	30x30x3,5	10	11,55 €
003014	200	35x35x4,0	10	17,15 €
003015	225	35x35x4,0	10	19,50 €
003016	250	35x35x4,0	10	21,85 €

## SUPPORTO POSA SAETTE SU MURO



Cod.	Descrizione	Conf.	Prezzo
054350	zincato	1	11,90 €
054351	plasticato	1	16,35 €

## SAETTA PLASTICATA AD L



Cod.	H cm	cm	Conf.	Prezzo
041401	120	25x25x3	10	5,74 €
041402	150	25x25x3	10	7,17 €
041403	200	25x25x3	10	10,05 €

## BARRA DI TENSIONE ZINCATA



Cod.	mm	Ø mm	Conf.	Prezzo
061810	1050	8	100	2,96 €
061811	1300	8	100	3,69 €
061812	1550	8	100	4,40 €
061813	1800	8	100	5,10 €
061814	2050	8	100	5,81 €

**TIRAFILO ZINCATO E PLASTICATO**



Cod.	Tipo	cm	Pz	Conf.	Prezzo
009192	zincato	9,50x3	100	1	0,88 €
004834	plastificato	9,50x3	100	1	0,97 €

**PINZA CHIUSURA ANELLI RETI**

MUNDIAL



Cod.	Descrizione	mm	Ø foro mm	Conf.	Prezzo
14140	mod. Piccolo	210	6,3	1	17,95 €
14142	mod. Grande	210	9,3	1	20,60 €

**TIRAFILO ZINCATO E PLASTICATO**



Cod.	Tipo	cm	Pz	Conf.	Prezzo
VQ01002100B	zincato	9,50x3	100	1	1,85 €
VQ02002100B	plastificato	9,50x3	100	1	2,18 €

**ANELLI RETE**

MUNDIAL

Finitura zincata.



Cod.	mm	Descrizione	kg	Conf.	Prezzo
14150	15x5	piccoli	1	1	13,00 €
14152	22x7	grandi	1	1	13,00 €

**TENDIFILO BREVETTATO ZINCATO**

STAW

Per filari medio corti con filo Ø 5 mm.



Cod.	n°	Conf.	Prezzo
148560	1	1	1,71 €
148561	2	1	2,06 €

**PINZA E PUNTI PER RETE**



Rapid



Cod.	Descrizione	Modello	Conf.	Prezzo
062772	pinza	FP222	1	57,20 €
062773	punti zincati	VR22 - 1,6 mm	1	27,50 €
062774	punti verdi	VR22 - 1,6 mm	1	41,10 €

**MANIGLIA PER TENDIFILO**

STAW



Cod.	Descrizione	Conf.	Prezzo
148563	brevettato	1	6,30 €

**ACCESSORI AGGRAFFATRICE**

CAVATORTA



Cod.	Descrizione	mm	Pz	Conf.	Prezzo
VQ2210B	pinza	16-20	-	1	26,10 €
VQ2625B	punti verdi	16	250	1	8,46 €
VQ2430B	punti verdi	20	1000	1	30,50 €

**FILI DI TENSIONE**

CAVATORTA

Plastificato verde.



Cod.	Ø mm	m	Conf.	Prezzo
FIV27364100B	2,7/3,6	100	1	27,85 €

## FILO FERRO PLASTIFICATO

100 m.



Cod.	Ø mm	Conf.	Prezzo
GA5718P	1,8	1	6,08 €
GA5720	2,7	1	12,30 €
GA5720P	3,3	1	15,26 €

## FILO FERRO ZINCATO E PLASTICATO GALVAPLAX

Particolarmente adatto sia nel settore agricolo sia in quello industriale con spiccata acidità dell'ambiente.



Cod.	Descrizione	mm	m	Conf.	Prezzo
056664	fine	1,5 - 1,8	1356	1	5,47 €
000351	medio	2,2 - 2,6	927	1	4,90 €
011484	grosso	2,7 - 3,2	821	1	4,83 €

## FILO FERRO ZINCATO



Cod.	n°	mm	Conf.	Prezzo
000349	5	1,00	25	4,81 €
001428	6	1,10	25	4,21 €
001429	8	1,30	25	4,44 €
001430	10	1,50	25	3,63 €
001431	12	1,80	25	3,42 €
039302	13	2,00	25	3,35 €
001432	14	2,20	25	3,32 €
001433	15	2,40	25	3,29 €
001434	16	2,70	25	3,27 €
000350	17	3,00	25	3,27 €
001435	18	3,50	25	3,27 €
011588	20	4,50	25	3,27 €

## FILO FERRO ZINCATO Galfort Doppia Zincatura



Cod.	Descrizione	mm	Conf.	Prezzo
001449	16	2,70	500	3,79 €

## FILO FERRO COTTO BIANCO CARPENTERIA IN BOBINA



Cod.	Descrizione	Conf.	Prezzo
001453	in bobina	25	3,03 €

## FILO FERRO COTTO NERO



Cod.	n°	Ø mm	Conf.	Prezzo
001441	13	2	25	3,53 €
001444	17	3	25	3,48 €

## FILO MULTIUSO CON ZINCATURA A CALDO

In rotolo.



Cod.	Ø mm	m	Conf.	Prezzo
15.10.150.1	1,50	50	10	3,42 €
15.10.180.1	1,80	50	10	4,46 €
15.11.220.1	2,20	100	5	11,35 €
15.11.270.1	2,70	100	5	16,20 €

## FILO MULTIUSO CON ZINCATURA A CALDO



Cod.	Ø mm	m	Conf.	Prezzo
15.01.080.1	0,80	40	30	1,04 €
15.01.090.1	0,90	30	30	1,04 €
15.01.100.1	1,00	27	30	1,04 €
15.01.120.1	1,20	25	30	1,04 €
15.01.130.1	1,30	22	30	1,04 €
15.01.150.1	1,50	16	30	1,04 €
15.01.180.1	1,80	12	30	1,04 €
15.01.200.1	2,00	10	30	1,04 €
15.01.220.1	2,20	9	30	1,04 €
15.01.250.1	2,50	7	30	1,04 €

## FILO MULTIUSO CON ZINCATURA A CALDO

Filo multiuso con zincatura a caldo rivestito con PVC. In rotolo.



Cod.	Ø mm	m	Conf.	Prezzo
15.02.070.1	0,70	50	30	1,18 €
15.02.090.1	0,90	33	30	1,04 €
15.02.110.1	1,10	24	30	1,04 €
15.02.140.1	1,40	13	30	1,04 €
15.02.160.1	1,60	10	30	1,04 €
15.02.180.1	1,80	7	30	1,04 €
15.02.220.1	2,20	5	30	1,04 €

## FILO MULTIUSO CON ZINCATURA A CALDO

Filo multiuso con zincatura a caldo rivestito con PVC. In rotolo.



Cod.	Ø mm	m	Conf.	Prezzo
15.12.180.1	1,80	50	10	4,09 €
15.12.200.1	2,00	50	10	4,85 €
15.12.270.1	2,70	50	10	6,08 €
15.13.180.1	1,80	100	5	7,20 €
15.13.200.1	2,00	100	5	9,13 €
15.13.270.1	2,70	100	5	11,85 €

## FUNE ZINCATA COMMERCIALE

Fune commerciale 42 fili. In rotolo.



Cod.	Ø mm	m	Conf.	Prezzo
17.02.010.2	2	10	10	2,22 €
17.02.025.2	2	25	10	5,04 €
17.02.100.1	2	100	1	16,95 €
17.03.010.2	3	10	10	3,63 €
17.03.025.2	3	25	10	8,96 €
17.03.100.1	3	100	1	29,50 €

## FUNE ZINCATA COMMERCIALE

Fune commerciale 72 fili. In rotolo.



Cod.	Ø mm	m	Conf.	Prezzo
17.04.010.2	4	10	10	5,19 €
17.04.025.2	4	25	10	12,35 €
17.04.100.1	4	100	1	36,90 €
17.05.010.2	5	10	10	6,34 €
17.05.025.2	5	25	10	15,15 €
17.05.100.1	5	100	1	15,15 €
17.06.010.2	6	10	10	7,90 €
17.06.025.2	6	25	10	19,35 €
17.06.100.1	6	100	1	67,60 €
17.08.010.2	8	10	10	12,30 €
17.08.025.2	8	25	10	30,60 €
17.08.050.1	8	50	1	110,50 €
17.08.100.1	8	100	1	110,50 €
17.10.050.1	10	50	1	88,10 €

## FUNE ACCIAIO INOX 316

49 fili. In rotolo.



Cod.	m	Ø mm	Carico rottura kg	Conf.	Prezzo
127118	25	2	260 ca.	10	11,65 €
127119	25	3	520 c.a.	10	20,40 €
127120	25	4	970 c.a.	1	34,50 €
127121	25	5	1500 c.a.	1	69,90 €
127122	25	6	2100 c.a.	1	68,10 €
127123	25	8	3800 c.a.	1	117,00 €

## FILO ZINCATO ART. 9



Cod.	N°	m	Conf.	Prezzo
025635	4	23	10	1,66 €
025636	6	19	10	1,66 €
025637	8	14	10	1,66 €
025638	10	12	10	1,66 €
026045	12	11	10	1,66 €

## FILO PLASTIFICATO ART. 18



filotecnica

Cod.	N°	m	Conf.	Prezzo
025630	4	25	10	1,68 €
025631	6	20	10	1,68 €
025632	8	16	10	1,68 €
025633	10	13	10	1,68 €
025634	12	9	10	1,68 €

## FILO RAME MAGNUM ART.2



filotecnica

Cod.	mm	m	Conf.	Prezzo
001461	1,5	19	1	16,30 €
015161	2,5	19	1	25,20 €

## FILO OTTONE ART.19



filotecnica

Cod.	mm	m	Conf.	Prezzo
026043	0,5	30	10	2,76 €
026044	0,8	12	10	2,76 €

## FILO ZINCATO FIORE ART. 4



filotecnica

Cod.	N°	m	Conf.	Prezzo
000353	4	25	10	1,08 €

## FILO RAME ART.3



filotecnica

Cod.	mm	m	Conf.	Prezzo
026046	0,5	30	10	2,76 €
026047	0,8	12	10	2,76 €

## FILO ACCIAIO ARMONICO ART. 12



filotecnica

Cod.	mm	m	Conf.	Prezzo
001458	0,8	22	10	2,40 €
000362	1,0	14	10	2,40 €
008089	1,4	7	10	2,28 €

## CHIODI TESTA PIANA

L'impiego è rivolto ai settori edile, artigianale, industriale, agricolo e zootecnico. Confezione da 5 kg.



Cod.	Misura	Conf.	Prezzo
PP13305KA	13x30	4	22,20 €
PP14405KA	14x40	4	20,00 €
PP15505KA	15x50	4	18,80 €
PP16605KA	16x60	4	16,60 €
PP17705KA	17x70	4	16,60 €
PP18805KA	18x80	4	16,60 €
PP201005KA	20x100	4	16,60 €
PP211205KA	21x120	4	16,60 €
PP231505KA	23x150	4	18,05 €
PP241805KA	24x180	4	20,10 €
PP242005KA	24x200	4	20,85 €
PP252505KA	25x250	4	18,05 €

## CHIODI ACCIAIO TESTA BOMBATA

L'impiego è rivolto principalmente ai settori edile, industriale ed artigianale. Confezione da 2,5 kg.



Cod.	Misura	Conf.	Prezzo
PAB30302K5A	3,0x30	4	15,00 €
PAB35402K5A	3,5x40	4	13,85 €
PAB35502K5A	3,5x50	4	13,85 €
PAB35602K5A	3,5x60	4	13,85 €
PAB35702K5A	3,5x70	4	13,85 €

## CHIODI BRICOLINE TESTA PIANA

L'impiego è rivolto al settore professionale e del bricolage. Confezione da 250 g.



Cod.	Misura	Conf.	Prezzo
BP05150K25B	1,0x15	40	4,13 €
BP08200K25B	1,3x20	40	4,13 €
BP14400K25B	2,2x40	40	3,17 €
BP15500K25B	2,4x50	40	3,17 €
BP16600K25B	2,7x60	40	3,17 €
BP18800K25B	3,5x80	40	3,17 €

## CHIODI BRICOLINE TESTA PIANA

L'impiego è rivolto al settore professionale e del bricolage. Confezione da 500 g.



Cod.	Misura	Conf.	Prezzo
BP13300K5B	2,0x30	16	4,18 €
BP14400K5B	2,2x40	16	4,18 €
BP15500K5B	2,4x50	16	4,18 €
BP16600K5B	2,7x60	16	4,18 €
BP17700K5B	3,0x70	16	4,18 €
BP18800K5B	3,5x80	16	4,18 €
BP201000K5B	4,5x100	16	4,18 €

## CHIODI BRICOLINE TESTA PIANA

L'impiego è rivolto al settore professionale e del bricolage. Confezione da 1 kg.



Cod.	Misura	Conf.	Prezzo
BP13301KB	2,0x30	12	6,23 €
BP14401KB	2,2x40	12	6,23 €
BP15501KB	2,4x50	12	6,23 €
BP16601KB	2,7x60	12	6,23 €
BP17701KB	3,0x70	12	6,23 €
BP18801KB	3,5x80	12	6,23 €
BP201001KB	4,5x100	12	6,23 €

## CHIODI BRICOLINE CAMBRETTE

L'impiego è rivolto al settore professionale e del bricolage. Confezione da 250 g.



Cod.	Misura	Conf.	Prezzo
BC12200K25B	1,8x20	40	4,13 €
BC14250K25B	2,2x25	40	3,17 €
BC16300K25B	2,7x30	40	3,17 €

## CHIODI ACCIAIO GRUPPINO

L'impiego è rivolto al settore professionale e del bricolage. Confezione da 1 kg.



Cod.	Misura	Conf.	Prezzo
BAG15251KB	1,5x25	12	14,10 €
BAG15301KB	1,5x30	12	14,10 €
BAG15351KB	1,35x35	12	14,10 €
BAG15401KB	1,5x40	12	14,10 €

## CHIODI BRICOLINE GRUPPINO

CAVATORTA

L'impiego è rivolto al settore professionale e del bricolage. Confezione da 250 g.



Cod.	Misura	Conf.	Prezzo
BG06200K25B	1,1x50	40	4,13 €
BG08250K25B	1,3x25	40	4,13 €
BG10300K25B	1,5x30	40	4,13 €
BG12400K25B	1,8x40	40	3,17 €
BG14500K25B	2,2x50	40	3,17 €

## CHIODI FERRO PUNTA TPL

Confezione da 1 kg.



Cod.	mm	Conf.	Prezzo
175273	11x16	1	7,73 €
175276	12x20	1	6,90 €
175277	12x25	1	6,90 €
175279	12x30	1	6,90 €
175253	17x22	1	5,88 €
175254	17x25	1	5,88 €
175255	17x30	1	5,88 €
175256	17x35	1	5,88 €
175257	17x40	1	5,88 €

## CHIODI GRUPPINO ACCIAIO

Confezione da 1 kg.



Cod.	mm	Conf.	Prezzo
175112	1,2x20	1	10,60 €
175113	1,2x25	1	10,60 €
175114	1,2x30	1	10,60 €
175123	1,5x25	1	10,60 €
175124	1,5x30	1	10,60 €
175125	1,5x40	1	10,60 €

## CHIODI FERRO PUNTA TPL

Confezione da 1 kg.



Cod.	mm	Conf.	Prezzo
175554	14x40	1	4,06 €
175555	15x50	1	4,06 €
175556	16x60	1	4,06 €
175557	17x70	1	4,06 €
175558	18x80	1	4,06 €
175560	20x100	1	4,06 €

## CHIODI CAMBRETTE FERRO

Confezione da 1 kg.



Cod.	mm	Conf.	Prezzo
175163	11x16	1	6,90 €
175165	12x20	1	6,63 €
175167	13x25	1	6,49 €
175168	16x30	1	6,08 €
175170	17x35	1	6,08 €
175174	18x40	1	6,08 €

## CHIODI FERRO PUNTA TPL

Confezione da 500 g.



Cod.	mm	Conf.	Prezzo
175583	13x30	1	2,83 €
175584	14x40	1	2,83 €
175585	15x50	1	2,83 €
175586	16x60	1	2,83 €
175588	18x80	1	2,83 €
175590	20x100	1	2,83 €

## CHIODI GRUPPINO FERRO

Confezione da 1 kg.



Cod.	mm	Conf.	Prezzo
175202	5x15	1	8,84 €
175205	8x20	1	6,90 €
175206	8x25	1	7,00 €
175208	9x30	1	6,16 €
175218	12x40	1	6,16 €
175223	13x50	1	6,16 €

## CHIODI FERRO PUNTA TPL

Confezione da 250 g.



Cod.	mm	Conf.	Prezzo
175613	13x30	1	2,79 €
175614	14x40	1	2,79 €
175615	15x50	1	2,79 €
175616	16x60	1	2,79 €
175617	17x70	1	2,79 €
175618	18x80	1	2,79 €
175620	20x100	1	2,79 €

**CARTELLO CIVILE  
PASSO CARRABILE**



Cod.	cm	Conf.	Prezzo
024906	30x20	10	1,24 €

**CARTELLO CIVILE LASCIARE LIBERO  
IL PASSAGGIO**



Cod.	cm	Conf.	Prezzo
024780	30x20	10	1,40 €

**CARTELLO CIVILE  
SOSTA VIETATA**



Cod.	cm	Conf.	Prezzo
024777	30x20	10	1,40 €

**CARTELLO CIVILE  
PARCHEGGIO PRIVATO**



Cod.	cm	Conf.	Prezzo
024781	30x20	10	1,24 €

**CARTELLO CIVILE SOSTA VIETATA  
ANCHE DI NOTTE**



Cod.	cm	Conf.	Prezzo
024778	30x20	10	1,24 €

**CARTELLO CIVILE  
CANCELLO AUTOMATICO**



Cod.	cm	Conf.	Prezzo
024782	30x20	10	1,24 €

**CARTELLO CIVILE DIVIETO DI SOSTA  
PROPRIETÀ PRIVATA**



Cod.	cm	Conf.	Prezzo
024779	30x20	10	1,24 €

**CARTELLO CIVILE VIETATO L'ACCESSO  
PROPRIETÀ PRIVATA**



Cod.	cm	Conf.	Prezzo
024783	30x20	10	1,40 €

**CARTELLO CIVILE RIMOZIONE FORZATA**



Cod.	cm	Conf.	Prezzo
024820	30x20	10	1,24 €

**CARTELLO CIVILE  
VIETATO L'ACCESSO**



Cod.	cm	Conf.	Prezzo
024784	30x20	10	1,40 €



## CARTELLO CIVILE VIETATO L'INGRESSO



Cod.	cm	Conf.	Prezzo
024787	30x20	10	1,24 €

## CARTELLO CIVILE DISPERSIONE CORRENTE



Cod.	cm	Conf.	Prezzo
024907	30x020	10	1,24 €

## CARTELLO CIVILE VIETATO ACCESSO AI NON ADDETTI



Cod.	cm	Conf.	Prezzo
024788	30x20	10	1,40 €

## CARTELLO CIVILE USCITA EMERGENZA



Cod.	cm	Conf.	Prezzo
024790	30x20	10	1,24 €

## CARTELLO CIVILE VIETATO FUMARE



Cod.	cm	Conf.	Prezzo
024789	30x20	10	1,22 €

## CARTELLO CIVILE USCITA EMERGENZA DESTRA



Cod.	cm	Conf.	Prezzo
024791	30x20	10	1,24 €

## CARTELLO CIVILE PARCHEGGIO RISERVATO CONDOMINI



Cod.	cm	Conf.	Prezzo
024785	30x20	10	1,24 €

## CARTELLO CIVILE USCITA EMERGENZA SINISTRA



Cod.	cm	Conf.	Prezzo
024792	30x20	10	1,24 €

## CARTELLO CIVILE PARCHEGGIO RISERVATO CLIENTI



Cod.	cm	Conf.	Prezzo
024786	30x20	10	1,24 €

## CARTELLO CIVILE ESTINTORE



Cod.	cm	Conf.	Prezzo
024809	30x20	10	1,24 €

**CARTELLO CARICHI SPORGENTI POLIIONDA**



Cod.	Descrizione	Conf.	Prezzo
008549	non a norma	10	6,00 €
027396	in alluminio a norma CEE - 50x50 cm	10	41,40 €

**CARTELLO CIVILE VENDESI**



Cod.	cm	Conf.	Prezzo
024800	30x20	10	1,37 €
061599	60x40	10	3,22 €

**CARTELLO CIVILE USCITA SICUREZZA PASSAGGIO LIBERO**



Cod.	cm	Conf.	Prezzo
024794	30x20	10	1,24 €

**CARTELLO CIVILE AFFITTASI**



Cod.	cm	Conf.	Prezzo
024801	30x20	10	1,40 €
061598	60x40	10	3,22 €

**CARTELLO CIVILE DIVIETO SCARICO MERCE**



Cod.	cm	Conf.	Prezzo
024795	30x20	10	1,22 €

**CARTELLO CIVILE STRADA PRIVATA**



Cod.	cm	Conf.	Prezzo
024798	30x20	10	1,40 €

**CARTELLO CIVILE COLTIVAZIONI PERICOLOSE**



Cod.	cm	Conf.	Prezzo
024796	30x20	10	1,24 €

**CARTELLO CIVILE PROPRIETÀ PRIVATA**



Cod.	cm	Conf.	Prezzo
024799	30x20	10	1,37 €

**CARTELLO CIVILE VIETATO L'INGRESSO**



Cod.	cm	Conf.	Prezzo
024793	30x20	10	6,79 €

**CARTELLO CIVILE CANI DA GUARDIA**



Cod.	cm	Conf.	Prezzo
024817	30x20	10	1,37 €

## CARTELLO CIVILE ATTENTI AL CANE LUPO



Cod.	cm	Conf.	Prezzo
024812	30x20	10	1,37 €

## CARTELLO ALLUMINI SOSTANZE VELENOSE



Cod.	cm	Conf.	Prezzo
040994	30x20	10	6,99 €

## CARTELLO CIVILE ATTENTI AL CANE FEROCO



Cod.	cm	Conf.	Prezzo
024815	30x20	10	1,24 €

## CARTELLO ALLUMINIO LOCALE VIDEO SORVEGLIATO



Cod.	cm	Conf.	Prezzo
018794	30x20	10	6,99 €

## CARTELLO CIVILE ATTENTI AL CANE DOBERMAN



Cod.	cm	Conf.	Prezzo
024814	30x20	10	1,37 €

## CARTELLO ADESIVO LOCALE VIDEO SORVEGLIATO



Cod.	cm	Conf.	Prezzo
030724	18x12	10	3,80 €

## CARTELLO CIVILE ATTENTI AL CANE E AL PADRONE



Cod.	cm	Conf.	Prezzo
024816	30x20	10	1,40 €

## CARTELLO CONCESSIONE EDILE



Cod.	cm	Conf.	Prezzo
061594	68x43	10	2,27 €
061595	60x80	10	5,30 €

## CARTELLO CIVILE DIVIETO ENTRATA CANI



Cod.	cm	Conf.	Prezzo
024819	30x20	10	1,24 €

## CARTELLO CIVILE CANTIERE CON SIMBOLI



Cod.	cm	Conf.	Prezzo
061596	88x68	10	10,25 €
061597	88x138	10	15,45 €

### CASSETTA POSTALE MIA + PLACCA

Sportello zincato giallo.  
Con tetto.



Cod.	Descrizione	cm	Conf.	Prezzo
PN02000	corpo + sportello	33x27x11	4	52,90 €
PN02002	placca cuccia	-	2	28,25 €
PN02003	placca gufo	-	2	28,25 €
PN02004	placca gatto	-	2	28,25 €

### CASSETTA MOD. DUBLO PER ESTERNO F.TO RIVISTA

Modello con tetto. In acciaio inox 18/10  
finitura TDL o ghisa.



Cod.	Descrizione	cm	Conf.	Prezzo
CPDR2EIXL	acciaio inox	22x11xh32,5	1	70,80 €

### CASSETTA MOD. CHALET PER ESTERNO

Legia zincata verniciata.



Cod.	Descrizione	cm	Conf.	Prezzo
GA3330	ghisa	36x10,5xh37	1	41,50 €

### CASSETTA POSTA INOX EVOLUZIONE TETTO APRIBILE



Cod.	Descrizione	cm	Conf.	Prezzo
PN00418	acciaio inox	32x22x7,5	1	36,40 €

### CASSETTA POSTALE EFFE-T EVO PER ESTERNO

Acciaio inox 18/10 finitura TDL.



Cod.	Descrizione	cm	Conf.	Prezzo
CPFTIXE	acciaio inox	22x11xh32,5	1	44,40 €

### CASSETTA POSTA SERRATURA CILINDRO



Cod.	Descrizione	cm	Conf.	Prezzo
2005CT4YB	bianca	35x23x8	1	23,10 €
2005CT4YV	verde	35x23x8	1	25,20 €
2005CT4YN	nera	35x23x8	1	25,20 €

### CASSETTA MOD. EFFE-T PER ESTERNO

Modello con tetto. In acciaio inox 18/10  
finitura TDL o ghisa.



Cod.	Descrizione	cm	Conf.	Prezzo
CPFTIX	acciaio inox	22x11xh32	1	44,40 €
CPFTGH	ghisa	22x11xh32	1	36,20 €

### CASSETTA MOD. VILLA PER ESTERNO

Formato rivista.



Cod.	Descrizione	cm	Conf.	Prezzo
PN00258	acciaio inox	25x10xh40,5	1	52,90 €

## CASSETTA POSTA MOD. PECHINO

Acciaio inox 18/10 finitura TDL.



Cod.	Descrizione	cm	Conf.	Prezzo
CPPEIX	acciaio inox	26x7xh38	1	65,70 €

## CASSETTA POSTALE UNO MAXI

La cassetta postale Uno Maxi è un formato rivista per esterni.



Cod.	Descrizione	cm	Conf.	Prezzo
CPUTMGH	ghisa	26,3x7xh39,5	1	47,20 €
CPUTM	rossa	26,3x7xh39,5	1	47,20 €
CPUTMV	verde	26,3x7xh39,5	1	47,20 €

## CASSETTA POSTA SIRIO

Cassetta postale per esterni in lamiera elettrozincata verniciata alle polveri. Adatta per installazioni a muro o cancellata con pratica apertura dall'alto.



Cod.	Descrizione	cm	Conf.	Prezzo
CPSIAV	avorio	28x11xh38,5	1	49,60 €
CPSIGH	ghisa	28x11xh38,5	1	49,60 €

## CASSETTA RACCOGLI PUBBLICITÀ

Permette di non confondere la propria corrispondenza privata con tutta la reclame che intasa le nostre buchette della posta, ma soprattutto evita di dover aprire a sconosciuti che vogliono distribuire pubblicità.



Cod.	Descrizione	cm	Conf.	Prezzo
CPPTAR	argento	34,5x12,5xh38,5	1	40,60 €

## CASSETTA POSTALE ESSE

Dal disegno classico, le cassette postali della "Serie ESSE" sono adattabili in qualsiasi contesto. In alluminio anodizzato o verniciato, disponibili in diversi colori.



Cod.	Descrizione	cm	Conf.	Prezzo
CPSEBR	bronzo	27,4x7xh29	1	50,40 €
CPSEGH	ghisa	27,4x7xh29	1	53,60 €
CPSEAR	argento	27,4x7xh29	1	50,40 €

## RACCOGLI PUBBLICITÀ

In lamiera zincata e policarbonato trasparente.



Cod.	cm	Conf.	Prezzo
GA3338	29x37x5x12	1	63,00 €

## CASSETTA MOD. EUROPA PER ESTERNO F.TO RIVISTA

Formato rivista. In alluminio pressofuso.



Cod.	Descrizione	cm	Conf.	Prezzo
CPEUR	rosso	29x10xh39	1	113,50 €
CPEUG	grigio	29x10xh39	1	113,50 €
CPEUN	nero	29x10xh39	1	113,50 €
CPEUV	verde	29x10xh39	1	113,50 €

## CASSETTA MOD. TOPOLINO PER ESTERNO F.TO RIVISTA

Cassetta originale americana in lamiera di acciaio zincato. Formato rivista.



Cod.	Descrizione	cm	Conf.	Prezzo
CPTR	rosso	48x17xh22	1	35,40 €
CPTN	nero	48x17xh22	1	35,40 €
CPTA	alluminio	48x17xh22	1	43,60 €
CPPT	palo per topolino	48x17xh22	1	30,00 €

### CASSETTA REGIE POSTE PER ESTERNO

In alluminio pressofuso  
verniciato. Formato rivista.



Cod.	Descrizione	cm	Conf.	Prezzo
GA3335	ghisa	25,5x8xh41	1	35,80 €
GA3336	rosso	25,5x8xh41	1	35,80 €
GA3337	verde	25,5x8xh41	1	35,80 €

### CHIAVE GREZZA



Cod.	Descrizione	Conf.	Prezzo
CP31CHSX	sinistra	1	2,42 €
CP31CHDX	destra	1	2,42 €

### SERRATURA TONDO MOBILE FAI PER CASSETTA

In ottone.



Cod.	mm	Conf.	Prezzo
031852	17,5	1	15,60 €
031853	21	1	16,05 €
031854	26	1	17,05 €

### LEVETTA DIRITTA PER CILINDRO



Cod.	Descrizione	Conf.	Prezzo
122686	diritta	12	2,60 €

### LEVETTA ZANCATA PER CILINDRO



Cod.	Descrizione	Conf.	Prezzo
122687	zancata	12	2,60 €

### CASSETTA PORTACHIAVI PRIVAT

Lamiera verniciata a polvere epossidica.  
Possibilità di fissaggio a muro.



Cod.	Descrizione	mm	Conf.	Prezzo
062841	20 posti	160x200x70	1	20,50 €
062842	48 posti	240x300x70	1	26,45 €
062843	84 posti	240x300x70	1	32,20 €

### CASSETTA PER PANE

In acciaio inox.



Cod.	mm	kg	Conf.	Prezzo
062840	250x230x340	2	1	50,20 €

### ARMADIETTO GAS

Serratura a vite quadrata.



Cod.	mm	Descrizione	Conf.	Prezzo
062844	300x500x250	lamiera zincata	1	39,20 €
062845	400x500x250	lamiera zincata	1	47,60 €
062846	400x600x250	lamiera zincata	1	53,20 €
062847	500x600x250	lamiera zincata	1	56,00 €

062856	600x40x250	acciaio inox	1	106,50 €
--------	------------	--------------	---	----------

### SPORTELLO ARMADIETTO GAS

Profondità 60 mm.



Cod.	mm	Descrizione	Conf.	Prezzo
062848	300x500	lamiera zincata	1	35,00 €
062849	400x500	lamiera zincata	1	42,00 €
062850	400x600	lamiera zincata	1	44,80 €
062851	500x600	lamiera zincata	1	47,60 €

062857	600x40	acciaio inox	1	32,70 €
--------	--------	--------------	---	---------

## SCHIENALE ARMADIETTO GAS

In lamiera zincata.



Cod.	mm	Conf.	Prezzo
062852	300x500	1	8,40 €
062853	400x500	1	11,20 €
062854	400x600	1	12,60 €
062855	500x600	1	14,00 €

## SERRATURA ARMADIETTO GAS



Cod.	Descrizione	Conf.	Prezzo
143920	serratura con chiave	1	3,30 €

## TAVELLINO PER SPORTELLI GAS METANO

In ferro zincato. Chiave a richiesta.



Cod.	Descrizione	Conf.	Prezzo
879021.000	ferro zincato	50	3,19 €

## CHIAVE PER TAVELLINO GAS METANO



Cod.	Descrizione	Conf.	Prezzo
879021A.000	in plastica	50	0,62 €
879021AM.000	in zama	50	1,19 €

## CHIAVE UNIVERSALE MULTIUSO A CROCE

Chiave universale multiuso con 4 profili. Idonea per l'apertura di cassette per contatori gas, Enel, pannelli di comandi elettrici, manichette antincendio, cancelli automatici, torni per officina, compressori.



Cod.	Descrizione	Conf.	Prezzo
797200	universale - 4 profili	1	6,26 €

## CASSAFORTE A MURO IDEAL 5

Spessore frontale 5 mm. Spessore corpo 2 mm. Catenacci girevole. Sistema di chiusura doppia mappa. Ripiani 1.



Cod.	HxLxP mm	kg	Conf.	Prezzo
122560	180x260x150	7	1	75,20 €
122561	200x300x150	8	1	85,70 €
122563	200x300x200	9	1	89,80 €
122565	300x410x200	15	1	161,00 €
122568	340x460x200	17	1	200,00 €

Cod.	Descrizione	Conf.	Prezzo
122557	chiave doppia mappa	1	5,04 €

## CASSAFORTE DIGITALE A MURO SUPRA

Spessore frontale in acciaio speciale 6 mm. Spessore corpo 2 mm. 2 catenacci Ø 20 mm. Sistema di apertura elettronico. Codice utente e codice master da 4 a 10 cifre. Sistema di sblocco di emergenza con chiave speciale. Ripiani 2.



Cod.	HxLxP mm	kg	Conf.	Prezzo
122570	260x360x150/250	8	1	169,50 €
122573	320x420x150/250	13	1	201,00 €

## CASSETTA VALORI ELEGANT

In acciaio verniciato di grande resistenza e qualità. Design dai bordi arrotondati e finitura testurizzata. Incorpora un vassoio nero multifunzione per conservare oggetti e monete. Con chiave seghettata. Colore blu.



Cod.	Misura	LxPxH mm	Conf.	Prezzo
122512	2	90x200x160	1	15,60 €
122516	4	90x300x240	1	24,40 €

**ARMADIO FUCILI**

4/5 posti fucile + tesoretto dotato di serratura in zama cromata con 2 chiavi. Finitura effetto legno. Con basi appoggia calcio in spugne nera e appoggia cannaq in polietilene antigraffio.



Cod.	cm	kg	Conf.	Prezzo
122538	140x26x23	60	1	447,00 €

**LUCCHETTO TSA**

Assicura che il contenuto della valigia possa essere controllato dalle dogane senza dover danneggiare la valigia o la cintura bagagli. Combinazione a 4 cifre. In vari colori.



Cod.	mm	Conf.	Prezzo
127577	28x43x13	6	14,70 €

**LUCCHETTO OTTONE A COMBINAZIONE**

In ottone massiccio, con spigoli smussati antiabrasione. Arco in acciaio cromato.



Cod.	mm	Descrizione	Conf.	Prezzo
030012	21x30x10	3 dischi	12	13,75 €
030014	28x41x12	3 dischi	12	15,85 €
030016	38x49,5x13	4 dischi	12	23,00 €

**LUCCHETTO INOX MARE**

Resistente alla corrosione.



Cod.	mm	Conf.	Prezzo
032964	30x28x13	12	15,65 €
032965	40x33x15	12	18,35 €
032966	50x41x17	6	25,10 €

**LUCCHETTO INOX MARE ARCO LUNGO**

Resistente alla corrosione.



Cod.	mm	Conf.	Prezzo
132629	30	12	16,55 €
132630	40	6	23,65 €
132631	50	6	28,10 €

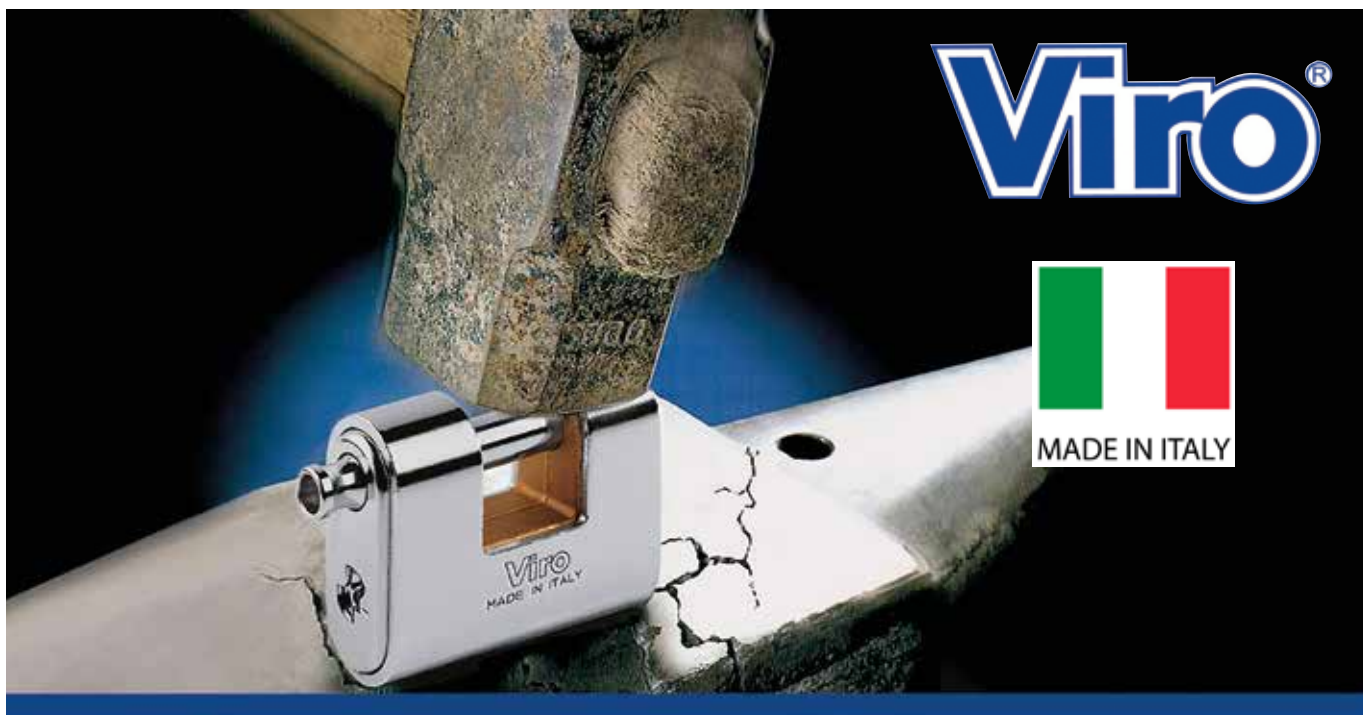



**LUCCHETTO IN OTTONE BLISTER**

Con arco corto.



Viro

Cod.	mm	Conf.	Prezzo
029965	16	12	5,93 €
029966	20	12	4,89 €
029968	25	12	6,14 €
029971	30	12	7,18 €
029972	40	12	8,22 €
029973	50	6	12,50 €
029976	60	6	17,80 €

**LUCCHETTO IN OTTONE ARCO LUNGO**

Chiusura a scatto.



Viro

Cod.	mm	Luce arco mm	Conf.	Prezzo
127579	25	AL 27	12	6,87 €
127580	30	AL 32	12	8,02 €
127582	40	AL 42	12	9,47 €
127584	50	AL 49	6	14,15 €

**LUCCHETTO IN OTTONE ARCO EXTRA LUNGO**

Chiusura a scatto.



Viro

Cod.	mm	Luce arco mm	Conf.	Prezzo
127588	30	AL 64	12	8,33 €
127589	40	AL 64	12	9,78 €
127590	50	AL 90	6	14,90 €

**LUCCHETTO IN OTTONE PESANTE**

Con arco corto.



AXEL

Cod.	mm	Conf.	Prezzo
FU-2660	20	12	2,07 €
FU-2665	25	12	2,54 €
FU-2670	30	12	3,71 €
FU-2675	40	12	5,09 €
FU-2680	50	12	9,01 €
FU-2685	60	12	11,60 €

**LUCCHETTO IN OTTONE PESANTE**

Con arco lungo.



AXEL

Cod.	mm	Conf.	Prezzo
FU-2715	30 - luce 30	12	4,78 €
FU-2720	40 - luce 40	12	6,49 €

**LUCCHETTO ADITUS ARCO NORMALE**

Corpo in ottone satinato e verniciato, arco in acciaio temperato e cromato. Due chiavi in dotazione.



ISEO

Cod.	mm	Luce arco mm	Conf.	Prezzo
090300	20	10	12	2,58 €
090301	25	15,5	12	2,91 €
090303	30	16	12	3,83 €
090305	40	23,9	12	5,47 €
090308	50	29,5	6	9,96 €
090310	60	37,5	6	15,50 €
090311	70	41	6	19,45 €

**LUCCHETTO ADITUS ARCO LUNGO**

Corpo in ottone satinato e verniciato, arco in acciaio temperato e cromato. Due chiavi in dotazione.



ISEO

Cod.	mm	Luce arco mm	Conf.	Prezzo
090302	25	25	12	3,29 €
090304	30	46	12	4,49 €
090306	40	47	12	6,00 €
090309	50	50	6	11,30 €

### LUCCHETTO ADITUS UNICA CIFRATURA

Corpo in ottone satinato e verniciato, arco in acciaio temperato cromato. Due chiavi in dotazione. Cifratura a scelta.



Cod.	mm	Luce arco mm	Conf.	Prezzo
090316	25	15,5	12	3,47 €
090317	30	16	12	4,48 €
090315	40	23,9	12	6,45 €
090318	50	29,5	6	11,60 €

### LUCCHETTO IUSTUS UNICA CIFRATURA RIPETIBILE

Corpo in ottone, arco in acciaio cromato. Due chiavi in dotazione. Cifratura unica ripetibile.



Cod.	mm	Luce arco mm	Conf.	Prezzo
090357	40 (3154)	22	12	13,50 €
090358	40 (3155)	22	12	13,50 €
090361	50 (4063)	28	10	22,10 €
090362	50 (4084)	28	10	22,10 €
090363	50 (4135)	28	10	22,75 €

### LUCCHETTO ADITUS RETTANGOLARE PER SERRANDA

Corpo in ottone satinato e verniciato, stelo in acciaio carbonitrurato e cromato. Bloccaggio con sfera. Due chiavi in dotazione.



Cod.	mm	Luce stelo mm	Conf.	Prezzo
090320	50	15x12,5	12	14,95 €
090322	70	22x14,5	6	23,55 €
090323	90	36x19	6	33,20 €

### LUCCHETTO ADITUS RETTANGOLARE CORAZZATO PER SERRANDA

Corpo in ottone. Corazza in acciaio sabbata, carbonitrurata e cromata. Stelo in acciaio carbonitrurato e cromato. Zigrinatura per apertura, bloccaggio stelo con sfera. Due chiavi in dotazione.



Cod.	mm	Luce stelo mm	Conf.	Prezzo
090325	60	22x11,5	6	38,50 €
090326	70	22x15	6	45,10 €
090327	90	36x18	6	48,70 €

### LUCCHETTO CLARUS RETTANGOLARE CORAZZATO MONOBLOCCO

Corpo in ottone. Corazza in acciaio sabbata, carbonitrurata e cromata. Stelo in acciaio carbonitrurato e cromato. Zigrinatura per apertura, bloccaggio stelo con sfera. Due chiavi in dotazione.



Cod.	mm	Luce stelo mm	Conf.	Prezzo
0909195	66	-	6	44,10 €
090920	84	-	6	50,40 €

### CILINDRO OTTONE SAGOMATO MOD. 920

5 perni, con nottolino in acciaio antifurto. Per serrature a infilare.



Cod.	L mm	Descrizione	Conf.	Prezzo
132333	54 (27+27)	ottone	10	13,65 €
132334	60 (27+33)	ottone	10	13,65 €
132335	60 (30+30)	ottone	10	13,65 €
132336	65 (30+35)	ottone	10	14,70 €
132337	70 (30+40)	ottone	10	14,70 €
132338	70 (35+35)	ottone	10	14,70 €
031791	80 (30+50)	ottone	10	19,45 €
132341	80 (35+45)	ottone	10	19,45 €
132342	80 (40+40)	ottone	10	19,45 €
132344	90 (35+55)	ottone	10	24,30 €
132345	90 (45+45)	ottone	10	24,30 €
031800	110 (30+80)	ottone	10	33,20 €
031802	120 (30+90)	ottone	10	40,10 €

### CILINDRO OTTONE EUROPRO FRIZIONATO MOD. 820

5 perni, con nottolino in acciaio antifurto. Per serrature a infilare.



Cod.	L mm	Descrizione	Conf.	Prezzo
132350	62 (31+31)	ottone	5	39,60 €
132351	66 (31+35)	ottone	5	40,80 €
132352	71 (31+40)	ottone	5	40,80 €
132354	70 (35+35)	ottone	5	40,80 €
132356	80 (35+45)	ottone	5	46,80 €
132357	80 (40+40)	ottone	5	46,80 €
132358	90 (40+50)	ottone	5	51,40 €

### CHIAVE PROFILO VIRO 061

Peso 550 g.



Cod.	Descrizione	Conf.	Prezzo
132372	4 pistoncini	1	1,27 €

### CHIAVE PROFILO UNIVERSALE 015

Profilo DX. Peso 1000 g.



Cod.	Descrizione	Conf.	Prezzo
132375	5 pistoncini	1	1,20 €

### CHIAVE PROFILO PIATTA 063.B

Simmetrica e reversibile. Peso 1000 g.

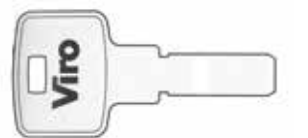

Cod.	Descrizione	Conf.	Prezzo
132370	5 pistoncini	1	3,51 €

### CHIAVE PROFILO SIMMETRICO 080

Peso 1100 g.



Cod.	Descrizione	Conf.	Prezzo
132377	5 pistoncini	1	1,41 €

### CHIAVE PER LUCCHETTO MEDIO ADITUS



Cod.	Pz	Conf.	Prezzo
090331	2	1	1,20 €

### CHIAVE PER LUCCHETTO PICCOLO ADITUS



Cod.	Pz	Conf.	Prezzo
090330	2	1	1,20 €

### CILINDRO F5 DOPPIO PROFILO OTTONE

Chiave 5 spine grande. Camma DIN 30°. Tre chiavi in dotazione.



Cod.	L mm	Descrizione	Conf.	Prezzo
090502	50 (25+25)	ottone	10	13,25 €
090506	56 (28+28)	ottone	10	16,55 €
090508	61 (28+33)	ottone	10	16,55 €
090510	60 (30+30)	ottone	10	16,55 €
090514	70 (30+40)	ottone	10	18,10 €
090516	70 (35+35)	ottone	10	18,10 €
090518	75 (30+45)	ottone	10	15,75 €
090520	75 (35+40)	ottone	10	15,75 €
090522	80 (30+50)	ottone	10	21,20 €
090526	80 (40+40)	ottone	10	21,20 €
090530	85 (35+50)	ottone	10	18,65 €
090534	90 (30+60)	ottone	10	21,45 €

### CILINDRO F5 DOPPIO PROFILO NICHELATO

Chiave 5 spine grande. Camma DIN 30°. Tre chiavi in dotazione.



Cod.	L mm	Descrizione	Conf.	Prezzo
090507	56 (28+28)	nicHEL	10	16,55 €
090509	61 (28+33)	nicHEL	10	13,25 €
090511	60 (30+30)	nicHEL	10	16,55 €
090515	70 (30+40)	nicHEL	10	18,10 €
090517	70 (35+35)	nicHEL	10	18,10 €
090523	80 (30+50)	nicHEL	10	16,95 €

### CILINDRO F5 MONOPROFILO

Chiave 5 spine grande. Camma DIN 8 posizioni. Tre chiavi in dotazione.



Cod.	L mm	Descrizione	Conf.	Prezzo
090570	40 (30+10)	ottone	10	14,65 €

### CILINDRO F5 DOPPIO PROFILO TONDO SFACCETTATO

Chiave 5 spine grande. Tre chiavi in dotazione.



Cod.	L mm	Descrizione	Conf.	Prezzo
090595	56 (28+28)	ottone	10	23,10 €

## CILINDRO F5 DOPPIO PROFILO OVALE PICCOLO

In ottone. Chiave 5 spine piccola. Tre chiavi in dotazione.



Cod.	L mm	Conf.	Prezzo
090601	54 (27+27)	10	17,70 €
090602	60 (27+33)	10	18,65 €
090604	60 (30+30)	10	18,65 €

## CILINDRO F5 ESTERNO STACCATO

Da abbinare a serrature senza cilindro esterno. Chiave 5 spine grande. Piastra e viti per fissaggio dall'interno. Tre chiavi in dotazione.



Cod.	Descrizione	Conf.	Prezzo
090620	per porte spessore max 85 mm	10	13,85 €

## CHIAVE PER LUCCHETTO 5 SPINE



Cod.	Pz	Conf.	Prezzo
090332	2	1	1,20 €

## CILINDRO R6 PLUS DOPPIO PROFILO OTTONE NICHELATO OPACO

Camma DIN 30°. Parti in dotazione: 1 chiave da cantiere, 5 chiavi padronali con cappuccio Codecard, Vite di fissaggio M5x65



Cod.	L mm	Conf.	Prezzo
090650	60 (30+30)	10	40,50 €
090651	65 (30+35)	10	41,10 €
090652	70 (35+35)	10	41,60 €
090653	70 (30+40)	10	41,60 €
090656	80 (30+50)	10	42,80 €
090662	90 (30+60)	10	43,80 €
090664	90 (40+50)	10	43,90 €

## CILINDRO R6 PLUS OTTONE NICHELATO OPACO

Codolo mm 8x75. Camma DIN 30°. Parti in dotazione: 1 chiave da cantiere, 5 chiavi padronali con cappuccio, codecard, vite di fissaggio M5x65.



Cod.	L mm	Conf.	Prezzo
090680	60 (30+30)	10	40,00 €
090681	65 (30+35)	10	40,30 €
090682	70 (30+40)	10	41,00 €
090683	80 (30+50)	10	42,40 €

## CHIAVE PER R6 PLUS



Cod.	Pz	Conf.	Prezzo
090335	2	1	3,52 €

## SERRATURA ELETTRICA SERIE 5

Soluzione ideale per i cancelli pedonali che delimitano le aree di una proprietà privata e sui portoni di ingresso dei palazzi. Regolabile in larghezza e destra/sinistra. Azionabile con un pulsante collocato all'interno dell'abitazione e collegabile a tutti i normali impianti citofonici.



Cod.	mm	Conf.	Prezzo
059327	entrata regolabile 50/60/70/80	1	67,00 €

## TETTuccio E PIASTRE PER ELETTROSERRATURE

Piastra porta elettroserratura ambidestra per serrature. Tettuccio per serratura e piastra porta bocchetta in acciaio zincato. Viti incluse.



Cod.	mm	Conf.	Prezzo
090718	120x125	6	14,75 €

## CONTATTI PER ELETTROSERRATURE

12V, 6 spessori da 2x22 mm, 4 da 2x16 mm ed 1 da 5 mm.



Cod.	Descrizione	Conf.	Prezzo
090721	coppia spessori	10	14,95 €

## COPPIA BOBINE PER ELETTROSERRATURE

Per serie 52\*\* 53\*\*



Cod.	Descrizione	Conf.	Prezzo
090722	12V-15W C.A.	10	25,90 €

### SERRATURA PER SERRAMENTI IN LEGNO CON POMOLO DX



Pomolo interno e cilindro staccato esterno, scrocco separato con tirante interno e richiamo con chiave esterno. Viti, bocchetta e 3 chiavi inclusi. **401**



Cod.	Descrizione	mm	Conf.	Prezzo
090730	catenaccio 2 mandate	entrata 40	10	60,60 €
090731	catenaccio 2 mandate	entrata 50	10	60,60 €
090732	catenaccio 3 mandate	entrata 60	10	60,60 €

### SERRATURA PER SERRAMENTI IN LEGNO CON POMOLO SX



Pomolo interno e cilindro staccato esterno, scrocco separato con tirante interno e richiamo con chiave esterno. Viti, bocchetta e 3 chiavi inclusi. **402**



Cod.	Descrizione	mm	Conf.	Prezzo
090735	catenaccio 2 mandate	entrata 50	10	60,60 €
090736	catenaccio 3 mandate	entrata 60	10	60,60 €

### SERRATURA PER SERRAMENTI IN LEGNO CON TIRANTE DX



Cilindro interno e cilindro staccato esterno, scrocco separato con tirante interno e richiamo con chiave esterno. Bocchetta, viti e 3 chiavi inclusi. **421**



Cod.	Descrizione	mm	Conf.	Prezzo
090740	catenaccio 2 mandate	entrata 40	10	59,30 €
090741	catenaccio 2 mandate	entrata 50	10	59,30 €
090742	catenaccio 3 mandate	entrata 60	10	60,60 €

### SERRATURA PER SERRAMENTI IN LEGNO CON TIRANTE SX



Cilindro interno e cilindro staccato esterno, scrocco separato con tirante interno e richiamo con chiave esterno. Bocchetta, viti e 3 chiavi inclusi. **422**



Cod.	Descrizione	mm	Conf.	Prezzo
090745	catenaccio 2 mandate	entrata 50	10	60,70 €
090746	catenaccio 3 mandate	entrata 60	10	60,60 €

### SERRATURA PER SERRAMENTI IN FERRO



Serratura zincata da applicare per ferro senza aletta, cilindro interno e cilindro fisso Ø 26x50 mm esterno, scrocco separato. Quadro maniglia 8 mm, catenaccio a 3 mandate. cod. 090750 - Destra **485**  
cod. 090751 - Sinistra **486**



Cod.	mm	Conf.	Prezzo
090750	entrata 60	10	57,70 €
090751	entrata 60	10	57,70 €

### SERRATURA PER SERRAMENTI IN FERRO CON TIRANTE DX



Serratura zincata da applicare senza aletta. 4 fori di fissaggio, cilindro interno e cilindro fisso Ø 26x50 mm, scrocco reversibile separato con tirante interno e richiamo con chiave esterno. Catenaccio a 3 mandate, bocchetta, 3 chiavi in dotazione. **431**



Cod.	mm	Conf.	Prezzo
090752	entrata 60	10	63,80 €
090753	entrata 70	10	63,80 €

### SERRATURA PER SERRAMENTI IN FERRO CON TIRANTE SX



Serratura zincata da applicare senza aletta. 4 fori di fissaggio, cilindro interno e cilindro fisso Ø 26x50 mm, scrocco reversibile separato con tirante interno e richiamo con chiave esterno. Catenaccio a 3 mandate, bocchetta, 3 chiavi in dotazione. **432**



Cod.	mm	Conf.	Prezzo
090754	entrata 60	10	63,80 €
090755	entrata 70	10	63,80 €

### SERRATURA PER MONTANTE



Serratura da infilare per montanti a scatola aperta. Frontale in acciaio cromato. Rullo regolabile. **764001**



Cod.	mm	Conf.	Prezzo
090770	frontale 122x16x3	10	20,90 €

### SERRATURA PER MONTANTE



Serratura da infilare per montanti a scatola aperta, cilindro ovale. Una mandata da 9 mm, frontale in acciaio cromato, catenaccio prolungato da 3 mm. Scrocco separato con richiamo tramite quadro maniglia da 8 mm. Entrata 15 mm. **7501510**



Cod.	mm	Conf.	Prezzo
090772	frontale 200x16x3	10	29,75 €

### SERRATURA PER MONTANTE

Serratura da infilare per montanti a scatola aperta, cilindro ovale. Una mandata da 9 mm, frontale in acciaio cromato, catenaccio prolungato da 3 mm. **Rullo regolabile.** Entrata 15 mm. **7521510**



Cod.	mm	Conf.	Prezzo
090774	frontale 200x16x3	10	29,75 €

### SERRATURA PER MONTANTE

Serratura da infilare per montanti a scatola aperta, cilindro ovale. Una mandata da 9 mm. Frontale in acciaio cromato, **catenaccio a filo frontale.** Entrata 15 mm. **7581510**



Cod.	mm	Conf.	Prezzo
090776	frontale 127x16x3	10	20,25 €

### SERRATURA PER SERRAMENTI IN LEGNO CILINDRO STACCATO ESTERNO

Serratura da applicare con pomolo sblocca catenaccio interno e cilindro staccato esterno. Catenaccio 6 mandate. Bocchetta, viti e 3 chiavi inclusi.



Cod.	mm	Conf.	Prezzo
090792	entrata 40	10	63,80 €
090793	entrata 50	10	52,30 €
090794	entrata 60	10	52,30 €

### SERRATURA PER SERRAMENTI IN LEGNO CILINDRO FISSO

Serratura da applicare con pomolo sblocca catenaccio interno e cilindro fisso da Ø 26x50 mm esterno. Catenaccio a 6 mandate. Bocchetta, ghiera e 3 chiavi inclusi.



Cod.	mm	Conf.	Prezzo
090796	entrata 50	10	52,30 €
090797	entrata 60	10	52,30 €

### SERRATURA PER SERRAMENTI IN LEGNO CON TIRANTE

Serratura da applicare con pomolo sblocca catenaccio interno e cilindro staccato esterno, scrocco separato con tirante interno e richiamo con chiave esterno. Catenaccio a 6 mandate. Bocchetta, viti e 3 chiavi inclusi.

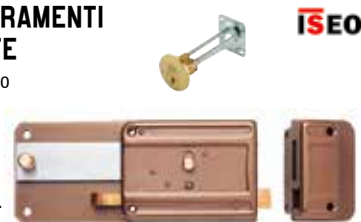

Cod.	mm	Conf.	Prezzo
090810	entrata 60	10	73,50 €

### SERRATURA PER CANCELLO UNA MANDATA

Scatola e frontale zincati tropicalizzato. Funzionante con cilindro sfaccettato Ø 26 mm. Catenaccio prolungato e scrocco incorporato. 1 mandata da 10 mm. Richiamo scrocco con chiave o quadro maniglia da 8 mm. Cilindro e 3 chiavi in dotazione. **600450**



Cod.	mm	Conf.	Prezzo
090820	entrata 45	10	32,00 €

### SERRATURA PER CANCELLO UNA MANDATA - SCROCCO INCORPORATO

Scatola e frontale zincati tropicalizzato. Funzionante con cilindro sfaccettato da Ø 26 mm. Catenaccio prolungato e scrocco incorporato. Una mandata da 10 mm. Richiamo scrocco con chiave o pomolo interno. 2 ghiera in nylon per cilindro. Cilindro e 3 chiavi in dotazione. **604451**



Cod.	mm	Conf.	Prezzo
090821	entrata 45	10	48,90 €

### SERRATURA PER CANCELLO DUE MANDATE

Scatola e fronte zincati tropicalizzato. Funzionante con cilindro sfaccettato Ø 26 mm. 2 mandate da 10 mm. 2 ghiera in nylon per cilindro. Cilindro e 3 chiavi in dotazione. **601450**



Cod.	mm	Conf.	Prezzo
090822	entrata 45	10	31,00 €

### SERRATURA PER CANCELLO DUE MANDATE SCROCCO SEPARATO

Scatola e frontale zincati tropicalizzato. Funzionante con cilindro sfaccettato di Ø 26 mm. Catenaccio e scrocco separato. 2 mandate da 10 mm. Richiamo scrocco con chiave o quadro maniglia da 8 mm. Cilindro e 3 chiavi in dotazione. **620350**



Cod.	mm	Conf.	Prezzo
090823	entrata 35	10	38,30 €

### SERRATURA PER CANCELLO DUE MANDATE CILINDRO A PROFILO EUROPEO



Scatola e frontale zincati tropicalizzato. Cilindro a profilo europeo, catenaccio e scrocco separato. 2 mandate da 10 mm. Richiamo scrocco con chiave o quadro maniglia da 8 mm. Cilindro da ordinare separatamente. **630350**



Cod.	mm	Conf.	Prezzo
090824	entrata 35	10	24,75 €

### SERRATURA TAGLIAFUOCO CANTINA



Serratura per porte tagliafuoco destre e sinistre. Un punto laterale, scrocco, e catenaccio. Frontale bordo arrotondato 34x3 mm, zincato. Quadro maniglia 9 mm. Interasse 72 mm.



Cod.	mm	Conf.	Prezzo
090778	entrata 65	10	22,60 €

### SERRATURA TAGLIAFUOCO ANTIPANICO



Serratura per porte tagliafuoco antipanico destre e sinistre (maniglia esterna). Frontale bordo arrotondato 24x3 mm zincato. Quadro maniglia sdoppiato 9 mm. Interasse 72 mm.



Cod.	mm	Conf.	Prezzo
090779	entrata 65	10	51,60 €

### MANIGLIONE ANTIPANICO IDEA BASE MODULARE



Reversibile, predisposto per chiusura laterale, duplice e triplice. Scrocco in zama senza autobloccante. Predisposto per aggancio aste per alto/basso, tappi per fori alto/basso. Spessore in nylon per comando esterno. Dima. **Triplice**



Cod.	Descrizione	Conf.	Prezzo
090900	verniciato nero	1	99,30 €

### MANIGLIONE ANTIPANICO IDEA BASE CHIUSURA LATERALE



Reversibile, scrocco in zama senza autobloccante, spessore in nylon per comando esterno. Dima. **Centrale**



Cod.	Descrizione	Conf.	Prezzo
090901	verniciato nero	1	85,80 €

### MANIGLIONE ANTIPANICO PUSH



Modulare reversibile, predisposto per aggancio aste. Scrocco in acciaio con autobloccante, idoneo per porte tagliafuoco. Tappi per fori alto/basso. Incontro laterale con spessori 1-2-3 mm.



Cod.	mm	Conf.	Prezzo
090905	1.170	1	186,50 €

### MANIGLIA PER PORTA ANTIPANICO



Maniglia e cilindro 5 spine profilo europeo incluso. Quadro maniglia. Viti di fissaggio. Spessore max dela porta 105 mm.



Cod.	Descrizione	Conf.	Prezzo
090910	verniciato nero	1	45,30 €

### COPPIA SCROCCHI PER PORTE ANTIPANICO CHIUSURA LATERALE



Per antipanico "Idea base". Chiusura laterale superiore e inferiore, scrocco in zama senza autobloccante. Viti di fissaggio incluse.



Cod.	Descrizione	Conf.	Prezzo
090911	verniciati nero	1	65,60 €

### COPPIA SCROCCHI PER PORTE ANTIPANICO CHIUSURA VERTICALE



Per antipanico "Idea base". Chiusura verticale alto e basso. Scrocco in zama senza autobloccante. Viti di fissaggio incluse.



Cod.	Descrizione	Conf.	Prezzo
090912	verniciati nero	1	65,60 €

### ASTA E COPERTURA PER MANIGLIONE ANTIPANICO



Per porte con altezza massima 240 cm.



Cod.	Descrizione	Conf.	Prezzo
090915	verniciato nero	5	31,60 €

### PLACCHE DI MASCHERAMENTO PER FORI

Abbinabili ai meccanismi centrali di tutti i maniglioni. Una placca per comando esterno e due placche per i meccanismi.



Cod.	Descrizione	Conf.	Prezzo
090720	verniciate nere	10	12,35 €

### BARRA ROSSA PER MANIGLIONE ANTIPANICO

Barra ovale orizzontale per maniglione antipanico serie "Idea base".



Cod.	mm	Conf.	Prezzo
090914	1130	1	14,95 €
090918	1330	1	27,70 €

### SERRATURA ELETTRONICA SENZA CILINDRO

Scatola e coperchio in acciaio zincato e plastificato. Frontale in acciaio nichelato e cromato.



Cod.	mm	Conf.	Prezzo
132408	130x64x16	1	65,70 €

### SERRATURA SENZA CILINDRO

Scatola e coperchio in acciaio zincato e plastificato. Frontale in acciaio nichelato e cromato.



Cod.	mm	Conf.	Prezzo
132400	130x78x16	1	23,75 €

### SERRATURA SENZA CILINDRO

Scatola e coperchio in acciaio zincato e plastificato. Frontale in acciaio nichelato e cromato.



Cod.	mm	Conf.	Prezzo
132412	150x44x16	1	17,65 €
132404	130x44x16	1	17,65 €

### SERRATURA SENZA CILINDRO

Scatola e coperchio in acciaio zincato e plastificato. Frontale in acciaio nichelato e cromato.



Cod.	mm	Conf.	Prezzo
132401	150x78x16	1	23,75 €
132402	130x64x16	1	23,75 €
132410	150x64x16	1	17,65 €
132414	160x64x16	1	17,65 €

### SERRATURA MONTANTE SENZA CILINDRO

Scatola e coperchio in acciaio zincato e plastificato. Frontale in acciaio nichelato e cromato.



Cod.	mm	Conf.	Prezzo
132417	28x150x16	1	24,30 €
132418	23x150x16	1	24,30 €

### CONTROPIASTRA NYLON R40/50

In nylon nero per serrature ed elettroserrature.



Cod.	mm	Conf.	Prezzo
132420	150x30,5	1	2,87 €

### CILINDRO SERRATURA

Corpo in alluminio rivestito ad alta resistenza alla corrosione e all'usura. Chiave a cresta. Con 5 perni in acciaio inox.



Cod.	mm	Conf.	Prezzo
132423	54 (27+27)	1	13,75 €
132424	60 (30+30)	1	13,75 €
132426	70 (35+35)	1	15,60 €
132428	60 (27+33)	1	13,75 €



### CILINDRO SERRATURA CON SICURA

Cilindro ovale doppio, in ottone nichelato. Perni in acciaio inox e contoperni in ottone.



Cod.	mm	Conf.	Prezzo
132430	60 (30+30)	1	26,15 €

### SERRATURA A INFILARE B/TONDO



Cod.	mm	Conf.	Prezzo
132306	25	1	22,45 €
132307	30	1	22,45 €
132308	35	1	22,45 €
132309	40	1	22,45 €
132310	45	1	22,45 €
132311	50	1	22,45 €
132312	60	1	22,45 €

### SERRATURA A INFILARE B/QUADRO



Cod.	mm	Conf.	Prezzo
132295	20	1	22,45 €
132296	25	1	22,45 €
132297	30	1	22,45 €
132298	35	1	22,45 €
132299	40	1	22,45 €
132300	45	1	22,45 €
132301	50	1	22,45 €
132302	60	1	22,45 €

### SERRATURA A SERRANDA CENTRALE



Cod.	Descrizione	Conf.	Prezzo
132315	centrale	2	25,50 €

### SERRATURA A SERRANDA DESTRA



Cod.	Descrizione	Conf.	Prezzo
132316	destra	2	24,30 €

### SERRATURA A SERRANDA SINISTRA



Cod.	Descrizione	Conf.	Prezzo
132317	sinistra	2	24,30 €

### SERRATURA CON CILINDRO PER BASCULANTE



Cod.	mm	Conf.	Prezzo
132320	67	2	28,60 €

### SERRATURA TONDO FISSO PER BASCULANTE



Cod.	Descrizione	Conf.	Prezzo
132325	26	1	18,80 €

### SERRATURA FEB/CORNI ELETTRICA MULTIPLA

Serratura multipla zincata, solo cilindro, reversibile. Incontro regolabile in altezza. Interassi dei fori di fissaggio unificati. Scrocco autobloccante. Cassa in acciaio. Alimentazione 8-12 VOLT. Cilindro nichelato.



Cod.	mm	Conf.	Prezzo
132235	entrata 50-70	1	64,20 €

CHIAVE F3 5SP DX



Cod.	Conf.	Prezzo
090686	100	1,20 €

CHIAVE ISEO SILVER  
LINE 5SP GR DX



Cod.	Conf.	Prezzo
090685	100	1,19 €

CHIAVE VERTICALE 6SP  
PER CILINDRO F6



Cod.	Conf.	Prezzo
090684	100	1,20 €

CHIAVI PER CILINDRO  
5SP ISEO



Cod.	Conf.	Prezzo
090340	100	1,27 €

CHIAVI PER CILINDRO  
DX 5S ISEO



Cod.	Conf.	Prezzo
090341	100	1,27 €

iseo.com

**ISEO**®

UN MONDO PIÙ SICURO



## CHIAVI CONIO

Con qualità comparabile a quella delle monete, Silca personalizza e rende uniche le vostre chiavi. Su ciascuna di esse potrete riprodurre il vostro logo, un'immagine della vostra città o un qualsiasi disegno. Per le chiavi più comuni Silca ha creato una serie di 18 diverse teste chiamate "Serie Distinzione", per darvi la più ampia possibilità di scelta.



**CHIAVE UNIVERSALE**



3 spine

SCUL048  
SCUL049

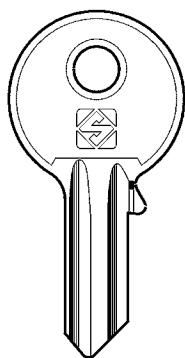

Cod.	Conf.	Prezzo
SCUL048	100	0,64 €
SCUL049	100	0,64 €

**CHIAVE UNIVERSALE**



5 spine

SCUL050  
SCUL051

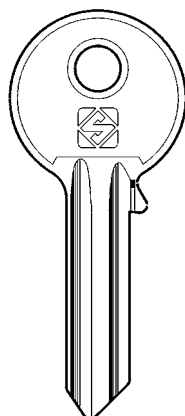

Cod.	Conf.	Prezzo
SCUL050	100	0,34 €
SCUL051	100	0,34 €

**CHIAVE UNIVERSALE**



4 spine

SCUL052  
SCUL053

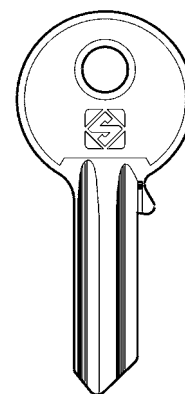

Cod.	Conf.	Prezzo
SCUL052	100	0,34 €
SCUL053	100	0,34 €

**CHIAVE UNIVERSALE**



6 spine

SCUL054  
SCUL055

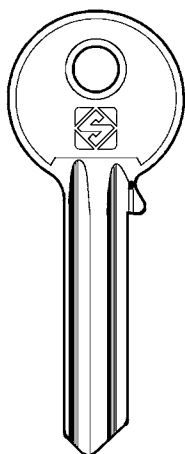

Cod.	Conf.	Prezzo
SCUL054	100	0,71 €
SCUL055	100	0,71 €

**CHIAVE UNIVERSALE**



3 spine ridotte

SCUL056

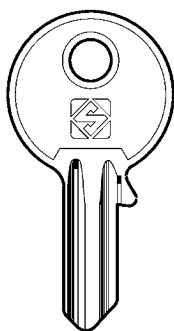

Cod.	Conf.	Prezzo
SCUL056	100	0,64 €

**CHIAVE UNIVERSALE**



5 spine ridotte

SCUL058  
SCUL059

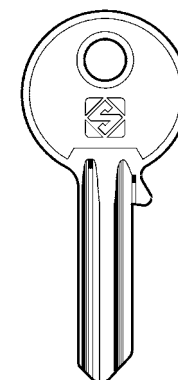

Cod.	Conf.	Prezzo
SCUL058	100	0,34 €
SCUL059	100	0,34 €

**CHIAVE UNIVERSALE**



4 spine ridotte

SCUL060  
SCUL061

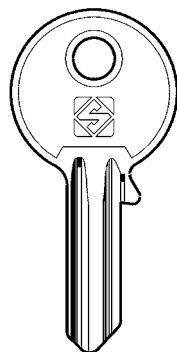

Cod.	Conf.	Prezzo
SCUL060	100	0,64 €
SCUL061	100	0,64 €

**CHIAVE PROFILO**



SCGE12R



Cod.	Conf.	Prezzo
SCGE12R	100	2,05 €

**CHIAVE PROFILO**



SCGS13

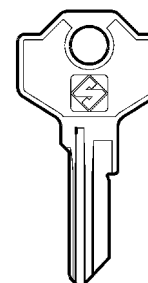

Cod.	Conf.	Prezzo
SCGS13	100	1,06 €

**CHIAVE PROFILO UNIVERSALE**



UNIVERSALE  
Testa tipo L -  
4 spine

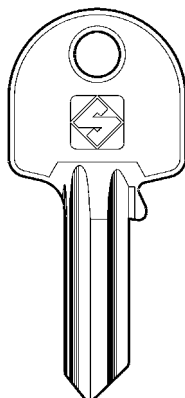

Cod.	Conf.	Prezzo
SCUL052L	100	0,74 €

**CHIAVE PROFILO UNIVERSALE**



UNIVERSALE  
Testa tipo L -  
5 spine

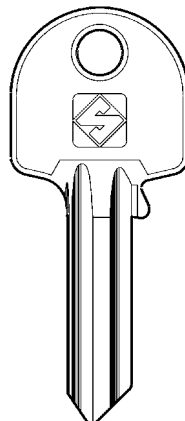

Cod.	Conf.	Prezzo
SCUL050L	100	0,74 €
SCUL051L	100	0,74 €

**CHIAVE PROFILO CISA ACCIAIO**



CISA

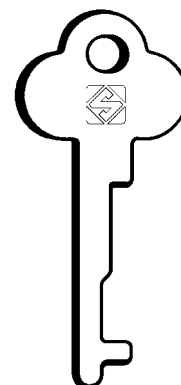

Cod.	Conf.	Prezzo
SC1003P1	100	1,16 €

**CHIAVE PROFILO AGB**



AGB - 5 spine

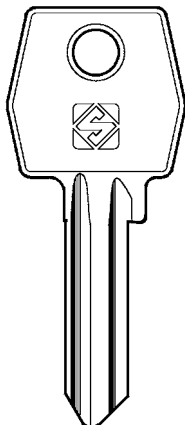

Cod.	Conf.	Prezzo
SCAGB1	100	1,01 €
SCAGB1R	100	0,71 €

**CHIAVE PROFILO AGB**



AGB - 4 spine

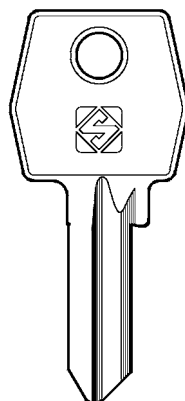

Cod.	Conf.	Prezzo
SCAGB2	100	1,06 €
SCAGB2R	100	1,01 €

**CHIAVE PROFILO AGB**



AGB - 5 spine ridotte

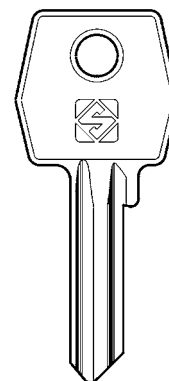

Cod.	Conf.	Prezzo
SCAGB3R	100	1,01 €

**CHIAVE PROFILO ALUBOX**



ALUBOX - 4 spine ridotte

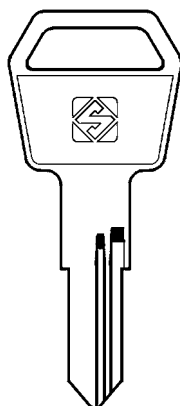

Cod.	Conf.	Prezzo
SCALU1	100	1,01 €

**CHIAVE PROFILO BETA**



BETA - 4 spine

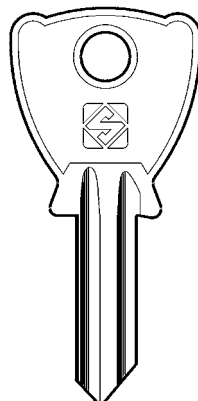

Cod.	Conf.	Prezzo
SCBE200	100	1,01 €
SCBE201	100	1,01 €

**CHIAVE PROFILO BETA**



BETA - 5 spine

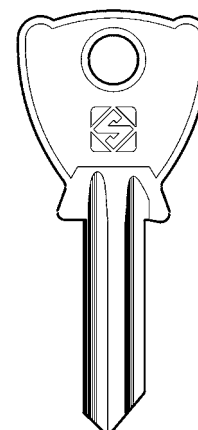

Cod.	Conf.	Prezzo
SCBE202	100	1,01 €
SCBE203	100	1,01 €

**CHIAVE PROFILO ACCIAIO BKS**

BKS - 5 spine



**CBK1510**

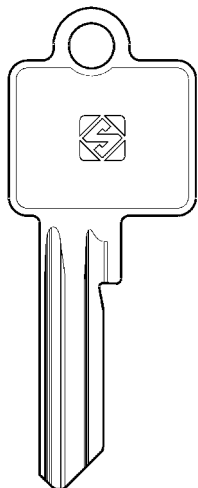

Cod.	Conf.	Prezzo
<b>SCBK1510</b>	50	2,05 €

**CHIAVE PROFILO BMB**

BMB - 5 spine



**SCBMB5**

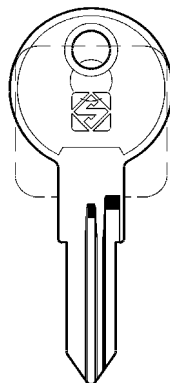

Cod.	Conf.	Prezzo
<b>SCBMB5</b>	100	1,80 €

**CHIAVE PROFILO ACCIAIO BRETER**

BRETER - 5 spine ridotte



**SCZD7**

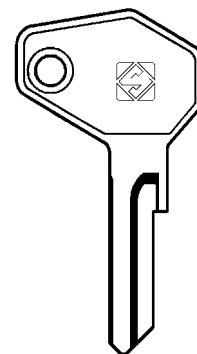

Cod.	Conf.	Prezzo
<b>SCZD7</b>	50	1,98 €

**CHIAVE PROFILO CAB**

CAB



**SCCAB2R**

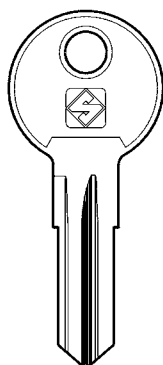

Cod.	Conf.	Prezzo
<b>SCCAB2R</b>	100	1,01 €

**CHIAVE PROFILO CAB**

CAB



**SCCAB1**

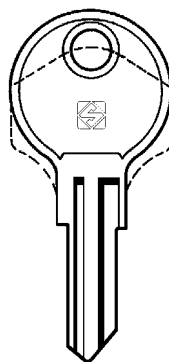

Cod.	Conf.	Prezzo
<b>SCCAB1</b>	100	1,06 €

**CHIAVE PROFILO CAS-CISMA**

CAS-CISMA - 4 spine ridotte



**SCCIS2**

**SCCIS4**

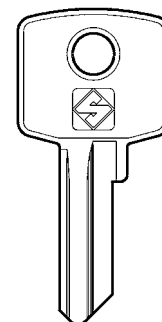

Cod.	Conf.	Prezzo
<b>SCCIS2</b>	100	0,71 €
<b>SCCIS4</b>	100	1,01 €

**CHIAVE PROFILO ACCIAIO CISA**

CISA - 5 spine



**SCCS85**

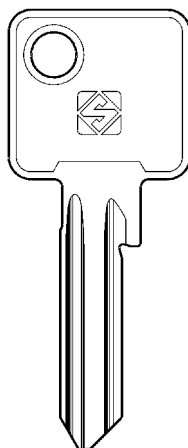

Cod.	Conf.	Prezzo
<b>SCCS85</b>	50	1,24 €

**CHIAVE PROFILO CISA**

CISA - 5 spine



**SCCS119**

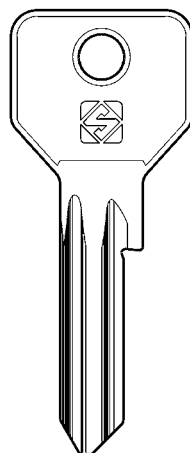

Cod.	Conf.	Prezzo
<b>SCCS119</b>	100	0,71 €

**CHIAVE PROFILO CISA**

CISA - 4 spine



**SCCS120**

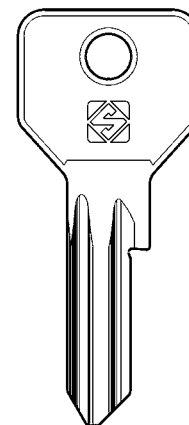

Cod.	Conf.	Prezzo
<b>SCCS120</b>	100	0,71 €

## CHIAVE PROFILO CISA



CISA - 5 spine ridotte

SCCS17  
SCCS46

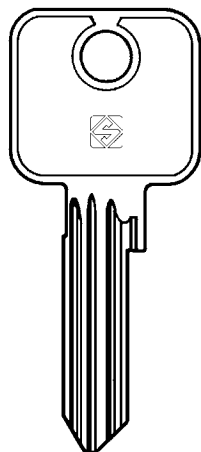

Cod.	Conf.	Prezzo
SCCS17	50	2,58 €
SCCS46	100	0,71 €

## CHIAVE PROFILO CISA



CISA - 4 spine

SCCS204  
SCCS205

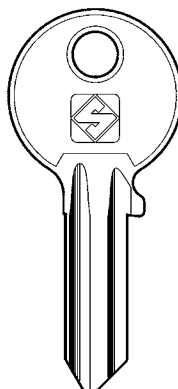

Cod.	Conf.	Prezzo
SCCS204	100	0,71 €
SCCS205	100	0,71 €

## CHIAVE PROFILO CISA



CISA - 5 spine

SCCS206  
SCCS207  
SCCS38  
SCCS68



Cod.	Conf.	Prezzo
SCCS206	100	0,71 €
SCCS207	100	0,71 €
SCCS38	100	1,01 €
SCCS68	100	1,89 €

## CHIAVE PROFILO CISA



CISA - 3 spine

SCCS4

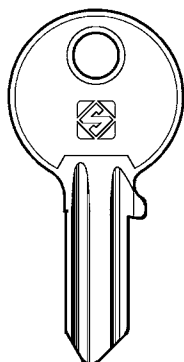

Cod.	Conf.	Prezzo
SCCS4	100	1,01 €

## CHIAVE PROFILO CISA



CISA - 4 spine

SCCS47

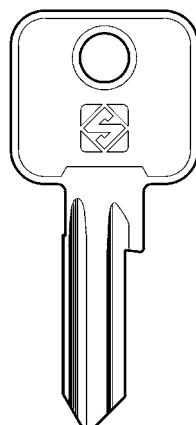

Cod.	Conf.	Prezzo
SCCS47	100	1,01 €

## CHIAVE PROFILO CISA



CISA - 6 spine

SCCS501

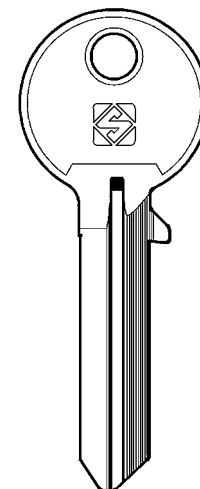

Cod.	Conf.	Prezzo
SCCS501	50	1,06 €

## CHIAVE PROFILO CISA



CISA - 4 spine ridotte

SCCS6

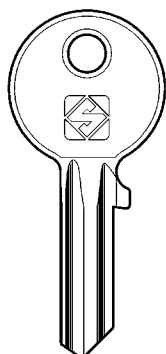

Cod.	Conf.	Prezzo
SCCS6	100	1,01 €

## CHIAVE PROFILO CISA



CISA - 5 spine ridotte

SCCS7  
SCCS7R

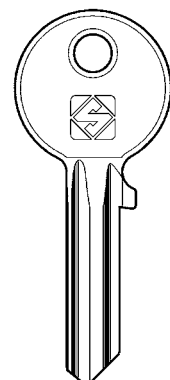

Cod.	Conf.	Prezzo
SCCS7	100	0,71 €
SCCS7R	100	1,01 €

## CHIAVE PROFILO CORBIN



CORBIN - 5 spine

SCCB1  
SCCB1R

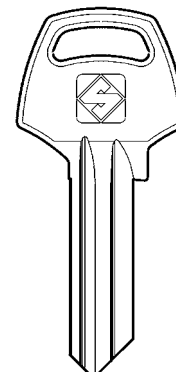

Cod.	Conf.	Prezzo
SCCB1	100	1,01 €
SCCB1R	50	0,79 €

**CHIAVE PROFILO CORBIN**



CORBIN - 5 spine



SCCB2

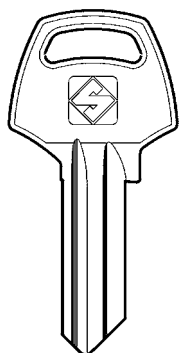

Cod.	Conf.	Prezzo
SCCB2	100	1,01 €

**CHIAVE PROFILO CORBIN**



CORBIN - 5 spine ridotte



SCCB3

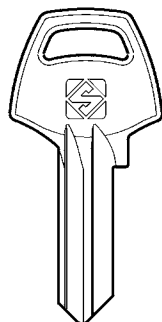

Cod.	Conf.	Prezzo
SCCB3	100	0,71 €

**CHIAVE PROFILO CORBIN**



CORBIN - 5 spine



SCCB30

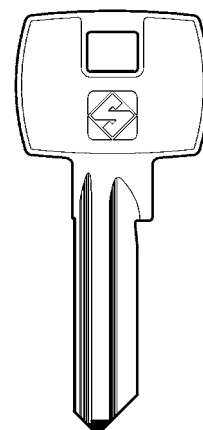

Cod.	Conf.	Prezzo
SCCB30	100	1,01 €

**CHIAVE PROFILO CORBIN**



CORBIN - 4 spine piccole



SCCB4

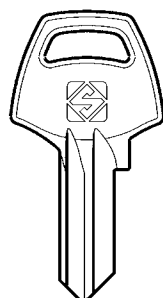

Cod.	Conf.	Prezzo
SCCB4	100	1,01 €

**CHIAVE PROFILO CORBIN**



CORBIN - 5 spine piccole



SCCB5

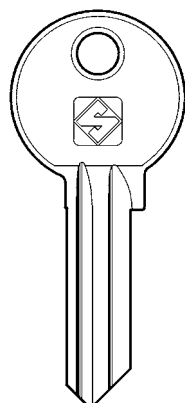

Cod.	Conf.	Prezzo
SCCB5	100	1,01 €

**CHIAVE PROFILO CORBIN**



CORBIN - 5 spine



SCCB6



SCCB78R

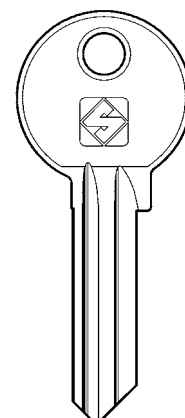

Cod.	Conf.	Prezzo
SCCB6	100	0,71 €
SCCB78R	50	3,15 €

**CHIAVE PROFILO CORBIN**



CORBIN - 5 spine



SCCB8

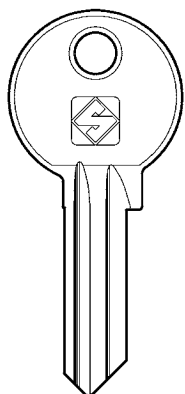

Cod.	Conf.	Prezzo
SCCB8	100	1,01 €

**CHIAVE PROFILO CORBIN**



CORBIN - 5 spine piccole



SCCB80

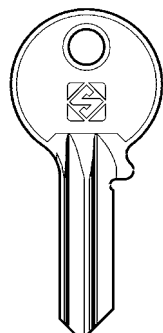

Cod.	Conf.	Prezzo
SCCB80	100	1,01 €

**CHIAVE PROFILO CORBIN**



CORBIN - 4 spine ridotte



SCCB81

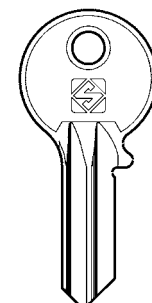

Cod.	Conf.	Prezzo
SCCB81	100	1,01 €



## CHIAVE PROFILO ACCIAIO CORBIN



CORBIN - 5 spine



SCCB101R

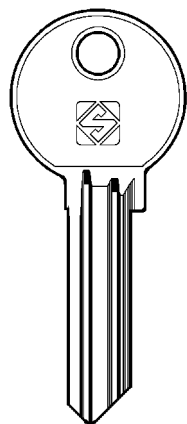

Cod.	Conf.	Prezzo
SCCB101R	100	0,79 €

## CHIAVE PROFILO CORNI



CORNI - 5 spine ridotte



SCCC1

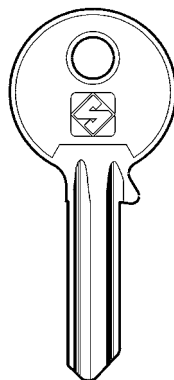

Cod.	Conf.	Prezzo
SCCC1	100	0,71 €

## CHIAVE PROFILO CORNI



CORNI - 5 spine

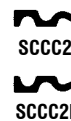

SCCC2

SCCC2R

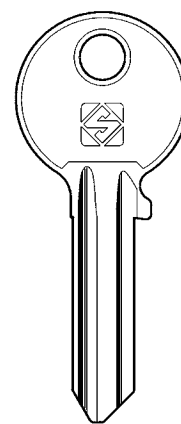

Cod.	Conf.	Prezzo
SCCC2	50	1,06 €
SCCC2R	100	1,01 €

## CHIAVE PROFILO DEXTER



DEXTER - 5 spine



SCDX1

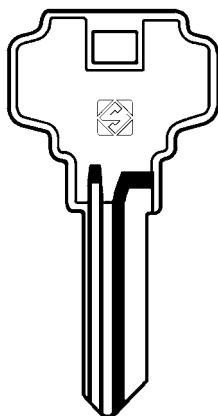

Cod.	Conf.	Prezzo
SCDX1	100	2,58 €

## CHIAVE PROFILO DOM



DOM - 5 spine ridotte



SCDM8

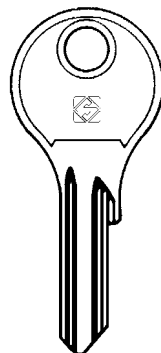

Cod.	Conf.	Prezzo
SCDM8	50	1,24 €

## CHIAVE PROFILO EURO LOCKS



EURO LOCKS - 5 spine ridotte



SCEU10R

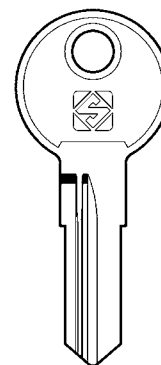

Cod.	Conf.	Prezzo
SCEU10R	100	1,24 €

## CHIAVE PROFILO EURO LOCKS



EURO LOCKS - 5 spine ridotte



SCEU13R

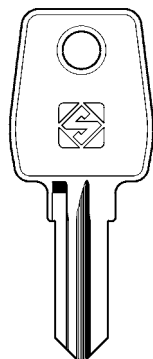

Cod.	Conf.	Prezzo
SCEU13R	100	1,24 €

## CHIAVE PROFILO EURO LOCKS



EURO LOCKS - 10 spine ridotte



SCEU1R

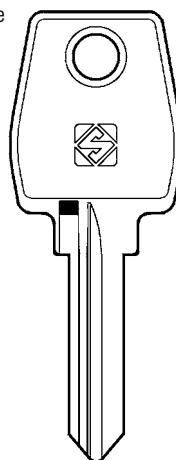

Cod.	Conf.	Prezzo
SCEU1R	50	1,89 €

## CHIAVE PROFILO EURO LOCKS



EURO LOCKS - 7 spine ridotte



SCEU5R

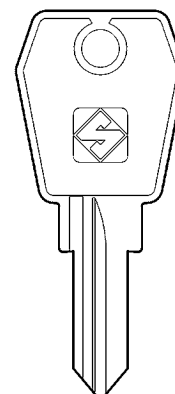

Cod.	Conf.	Prezzo
SCEU5R	500	1,89 €

**CHIAVE PROFILO EURO LOCKS**



EURO LOCKS - 5 spine ridotte

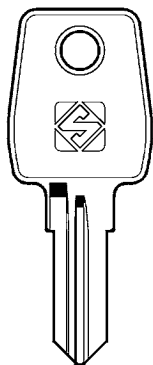

Cod.	Conf.	Prezzo
SCLF22R	50	1,24 €
SCLF23R	100	1,89 €

**CHIAVE PROFILO EURO LOCKS**



EURO LOCKS - 5 spine ridotte

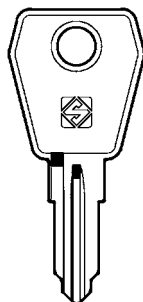

Cod.	Conf.	Prezzo
SCLF30R	100	1,89 €

**CHIAVE PROFILO EURO LOCKS**



EURO LOCKS - 5 spine ridotte

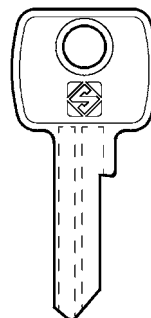

Cod.	Conf.	Prezzo
SCLF4	100	1,89 €

**CHIAVE PROFILO EURO LOCKS**



EURO LOCKS - 5 spine ridotte

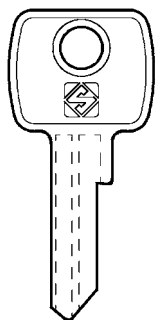

Cod.	Conf.	Prezzo
SCLF6R	100	1,89 €

**CHIAVE PROFILO LOWE & FLETCHER**



LOWE & FLETCHER - 5 spine ridotte

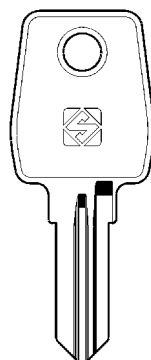

Cod.	Conf.	Prezzo
SCLF57	100	1,89 €

**CHIAVE PROFILO FASEM**



FASEM - 5 spine

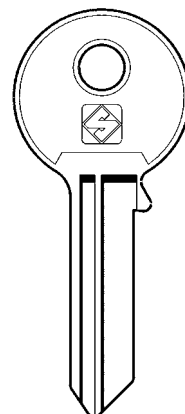

Cod.	Conf.	Prezzo
SCFM090	100	1,01 €

**CHIAVE PROFILO FASEM**



FASEM - 4 spine

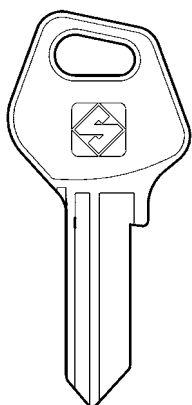

Cod.	Conf.	Prezzo
SCFM1	100	1,01 €

**CHIAVE PROFILO FASEM**



FASEM - 4 spine

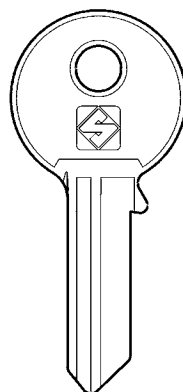

Cod.	Conf.	Prezzo
SCFM2	100	1,01 €

**CHIAVE PROFILO FASEM**



FASEM - 5 spine

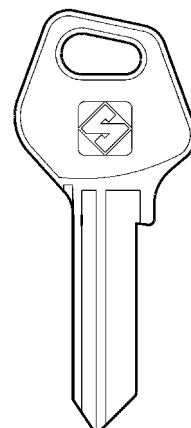

Cod.	Conf.	Prezzo
SCFM6	100	1,06 €

**CHIAVE PROFILO FEB**



FEB - 4 spine

SCFEB1R

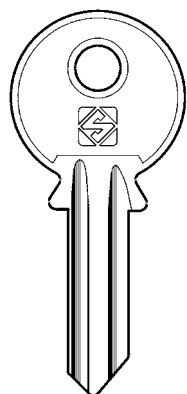

Cod.	Conf.	Prezzo
SCFEB1R	50	1,06 €

**CHIAVE PROFILO FEB**



FEB - 5 spine

SCFEB2  
SCFEB2R

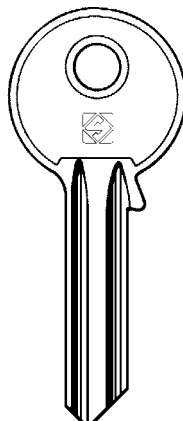

Cod.	Conf.	Prezzo
SCFEB2	100	1,06 €
SCFEB2R	50	1,06 €

**CHIAVE PROFILO FEB**



FEB

SCFEB6R

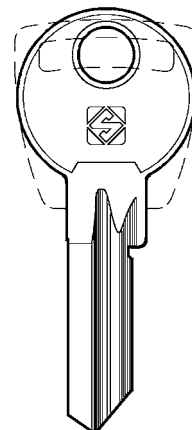

Cod.	Conf.	Prezzo
SCFEB6R	50	1,06 €

**CHIAVE PROFILO FF**



FF - 5 spine

SCFF1

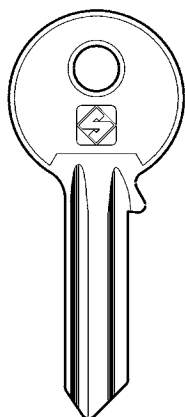

Cod.	Conf.	Prezzo
SCFF1	100	1,01 €

**CHIAVE PROFILO FIAM**



FIAM - 4 spine

SCFI232  
SCFI233

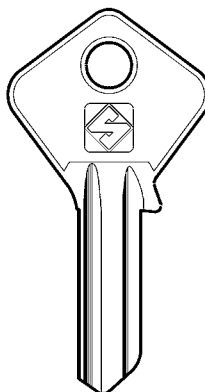

Cod.	Conf.	Prezzo
SCFI232	100	1,01 €
SCFI233	100	1,01 €

**CHIAVE PROFILO FIAM**



FIAM - 5 spine

SCFI234

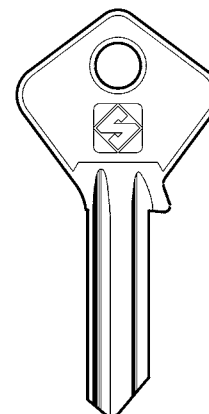

Cod.	Conf.	Prezzo
SCFI234	100	1,01 €

**CHIAVE PROFILO GEGE**



GEGE - 5 spine

SCGE1

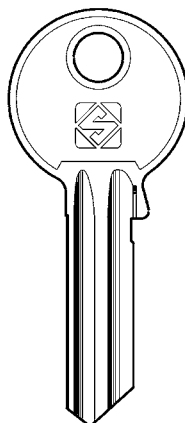

Cod.	Conf.	Prezzo
SCGE1	50	1,24 €

**CHIAVE PROFILO GEGE**



GEGE - 5 spine

SCGE1X

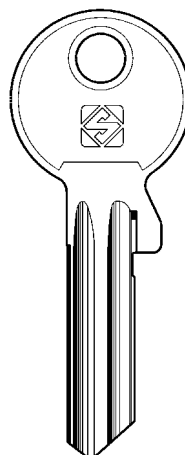

Cod.	Conf.	Prezzo
SCGE1X	50	1,89 €

**CHIAVE PROFILO GIUSSANI**



GIUSSANI - 5 spine ridotte

SCGS1  
SCGS4

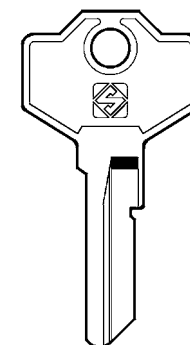

Cod.	Conf.	Prezzo
SCGS1	100	1,01 €
SCGS4	100	1,01 €

**CHIAVE PROFILO HOPPE**



HOPPE - 5 spine ridotte

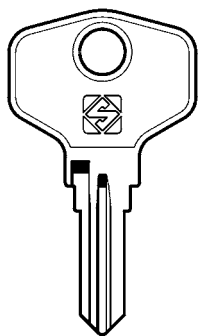

Cod.	Conf.	Prezzo
SCHPP1R	100	1,89 €

**CHIAVE PROFILO HUWIL**



HUWIL - 5 spine ridotte

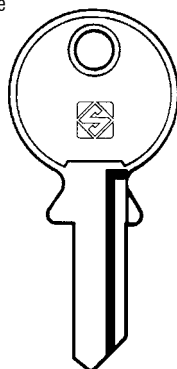

Cod.	Conf.	Prezzo
SCHW1	100	1,89 €

**CHIAVE PROFILO ISEO**



ISEO - 5 spine

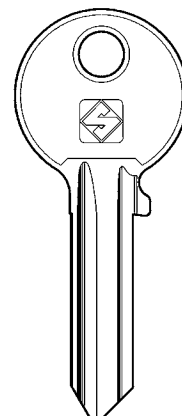

Cod.	Conf.	Prezzo
SCIE6	100	0,71 €
SCIE2	100	1,01 €
SCIE27R	100	0,79 €

**CHIAVE PROFILO ISEO**



ISEO - 4 spine ridotte

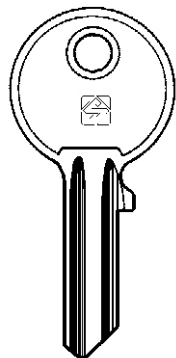

Cod.	Conf.	Prezzo
SCIE4	100	1,06 €

**CHIAVE PROFILO ISEO**



ISEO - 4 spine

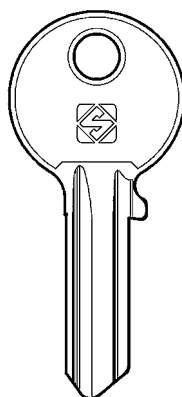

Cod.	Conf.	Prezzo
SCIE7	100	1,01 €
SCIE224	100	1,01 €
SCIE225	100	1,01 €

**CHIAVE PROFILO ISEO**



ISEO - 5 spine ridotte

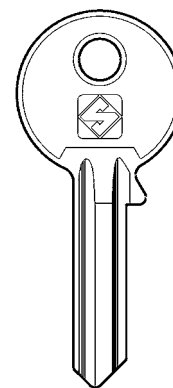

Cod.	Conf.	Prezzo
SCIE3	100	0,71 €

**CHIAVE PROFILO ISEO**



ISEO - 5 spine

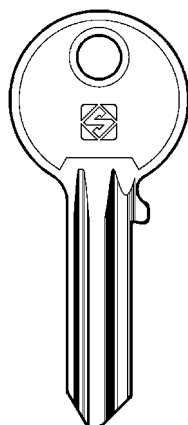

Cod.	Conf.	Prezzo
SCIE31	100	0,74 €

**CHIAVE PROFILO MERONI**



MERONI - 4 spine ridotte

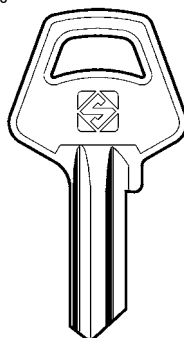

Cod.	Conf.	Prezzo
SCMER1	100	0,71 €
SCMER1R	100	1,01 €

**CHIAVE PROFILO MERONI - EVERGOOD**



MERONI - EVERGOOD  
5 spine ridotte

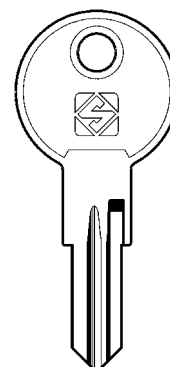

Cod.	Conf.	Prezzo
SCED2	50	3,78 €

**CHIAVE PROFILO MERONI**



MERONI - 4 spine ridotte



SCMER2

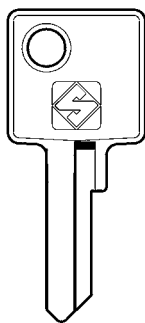

Cod.	Conf.	Prezzo
SCMER2	100	0,71 €

**CHIAVE PROFILO MERONI**



MERONI - 4 spine ridotte



SCMER24

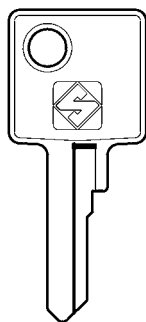

Cod.	Conf.	Prezzo
SCMER24	100	1,01 €

**CHIAVE PROFILO MERONI**



MERONI - 5 spine ristrette



SCMER4

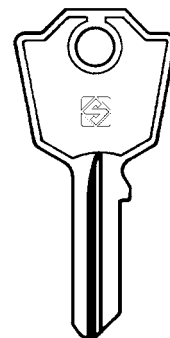

Cod.	Conf.	Prezzo
SCMER4	100	1,01 €

**CHIAVE PROFILO MERONI**



MERONI - 5 spine



SCMER8

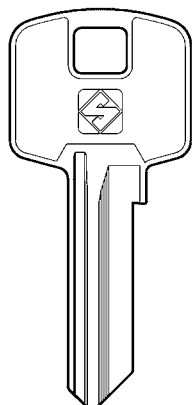

Cod.	Conf.	Prezzo
SCMER8	100	0,71 €

**CHIAVE PROFILO MERONI**



MERONI - 5 spine



SCMER13R

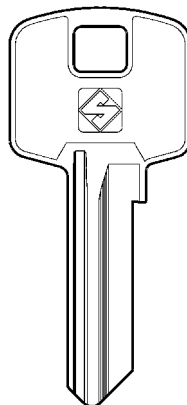

Cod.	Conf.	Prezzo
SCMER13R	100	1,06 €

**CHIAVE PROFILO MERONI**



MERONI - 4 spine ridotte



SCMER36

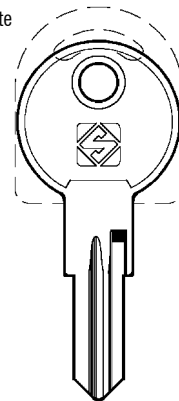

Cod.	Conf.	Prezzo
SCMER36	100	0,95 €

**CHIAVE PROFILO MG (MONTI)**



MG (MONTI) - 5 spine



SCMG1



SCMG1R



SCMN9R

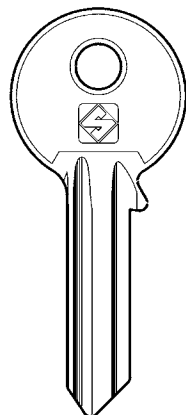

Cod.	Conf.	Prezzo
SCMG1	100	1,01 €
SCMG1R	100	1,01 €
SCMN9R	100	1,06 €

**CHIAVE PROFILO MG (MONTI)**



MG (MONTI) - 4 spine



SCMG2

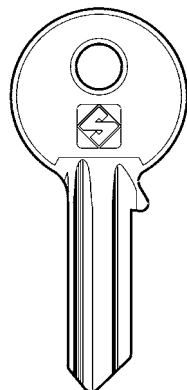

Cod.	Conf.	Prezzo
SCMG2	100	1,01 €

**CHIAVE PROFILO MLM**



MLM - 5 spine



SCMLM1

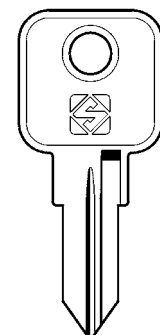

Cod.	Conf.	Prezzo
SCMLM1	50	1,89 €

**CHIAVE PROFILO OMEC**



OMEC - 5 spine ridotte

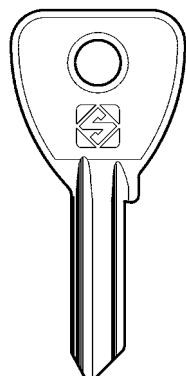

Cod.	Conf.	Prezzo
SCOC074	100	0,71 €

**CHIAVE PROFILO OMEC**



OMEC - 4 spine

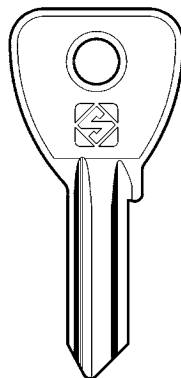

Cod.	Conf.	Prezzo
SCOC236	100	1,01 €
SCOC237	100	1,01 €

**CHIAVE PROFILO OMEC**



OMEC - 5 spine

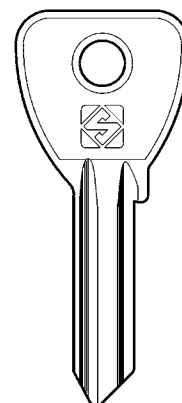

Cod.	Conf.	Prezzo
SCOC238	100	1,01 €

**CHIAVE PROFILO OMEC**



OMEC - 5 spine

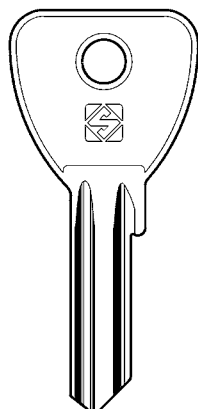

Cod.	Conf.	Prezzo
SCOC5	100	1,01 €

**CHIAVE PROFILO OMR**



OMR

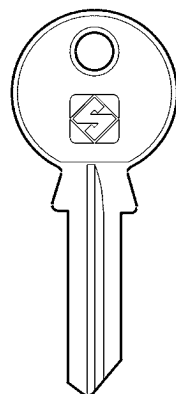

Cod.	Conf.	Prezzo
SCMH2	100	1,01 €

**CHIAVE PROFILO OMR**



OMR

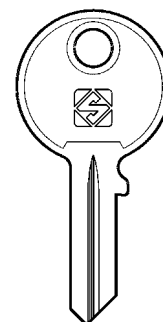

Cod.	Conf.	Prezzo
SCOMR1R	100	1,06 €

**CHIAVE PROFILO OMR**



OMR

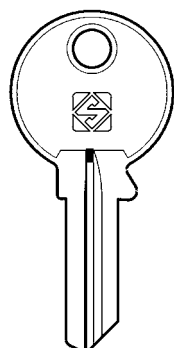

Cod.	Conf.	Prezzo
SCPT1	100	1,01 €
SCPT1R	100	1,01 €

**CHIAVE PROFILO PREFER**



PREFER - 4 spine ridotte

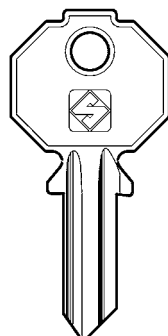

Cod.	Conf.	Prezzo
SCPF070	100	1,01 €

**CHIAVE PROFILO PREFER**



PREFER - 5 spine ridotte

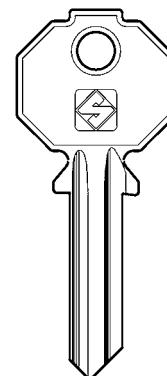

Cod.	Conf.	Prezzo
SCPF072	100	1,01 €

## CHIAVE PROFILO PREFER



PREFER - 5 spine

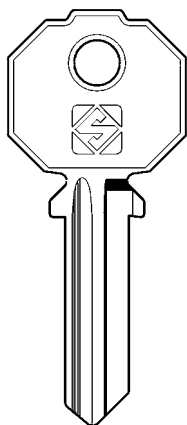

Cod.	Conf.	Prezzo
SCPF092	100	1,01 €
SCPF092S	100	1,01 €

## CHIAVE PROFILO PREFER



PREFER

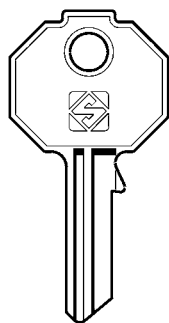

Cod.	Conf.	Prezzo
SCPF1	100	1,01 €

## CHIAVE PROFILO PREFER



PREFER - 4 spine

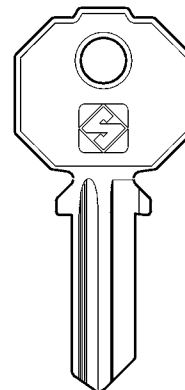

Cod.	Conf.	Prezzo
SCPF2	100	1,01 €
SCPF212	100	1,01 €
SCPF2S	100	1,01 €

## CHIAVE PROFILO PREFER



PREFER - 3 spine

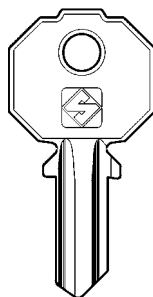

Cod.	Conf.	Prezzo
SCPF208	100	1,01 €

## CHIAVE PROFILO PREFER



PREFER - 5 spine

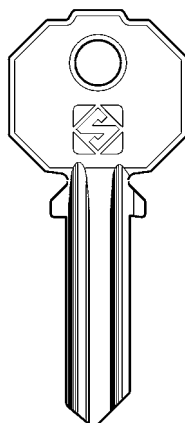

Cod.	Conf.	Prezzo
SCPF210	100	1,01 €

## CHIAVE PROFILO PREFER



PREFER - 3 spine

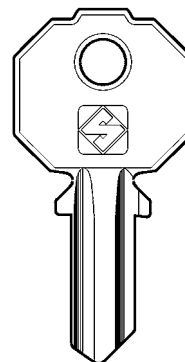

Cod.	Conf.	Prezzo
SCPF5	100	1,01 €
SCPF5S	100	1,01 €

## CHIAVE PROFILO ACCIAIO RENZ



RENZ - 5 spine ridotte

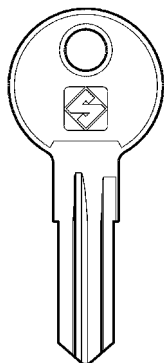

Cod.	Conf.	Prezzo
SCREN1	100	0,79 €

## CHIAVE PROFILO SIMECA



SIMECA - 5 spine ridotte

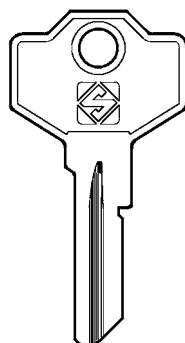

Cod.	Conf.	Prezzo
SCSM1	100	0,71 €
SCSM1R	100	1,01 €

## CHIAVE PROFILO SIS



SIS - 5 spine ridotte

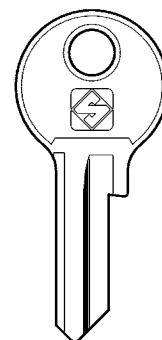

Cod.	Conf.	Prezzo
SCSS10	100	1,01 €

**CHIAVE PROFILO TESA**



TESA - 5 spine



SCTE2

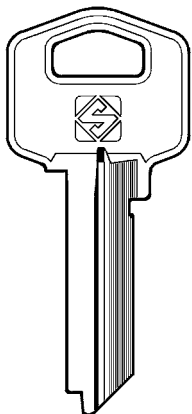

Cod.	Conf.	Prezzo
SCTE2	100	1,89 €

**CHIAVE PROFILO VIRO**



VIRO - 5 spine



SCVI080



SCVI081

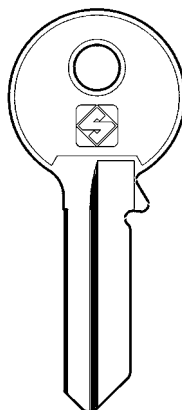

Cod.	Conf.	Prezzo
SCVI080	100	0,71 €
SCVI081	100	0,71 €

**CHIAVE PROFILO VIRO**



VIRO - 4 spine



SCVI082



SCVI083

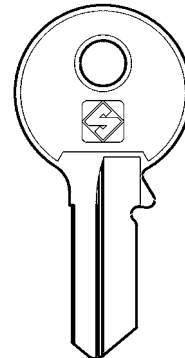

Cod.	Conf.	Prezzo
SCVI082	100	0,71 €
SCVI083	100	1,01 €

**CHIAVE PROFILO VIRO**



VIRO - 4 spine ridotte



SCVI084



SCVI085

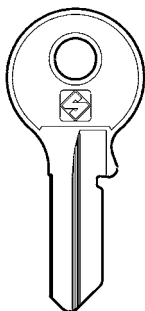

Cod.	Conf.	Prezzo
SCVI084	100	0,71 €
SCVI085	100	1,01 €

**CHIAVE PROFILO VIRO  
VI086**



VIRO - 5 spine ridotte



SCVI086



SCVI087

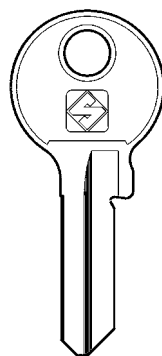

Cod.	Conf.	Prezzo
SCVI086	100	0,71 €
SCVI087	100	0,71 €

**CHIAVE PROFILO VIRO**



VIRO - 3 spine ridotte



SCVI088

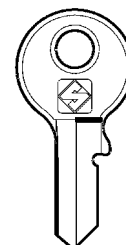

Cod.	Conf.	Prezzo
SCVI088	100	1,06 €

**CHIAVE PROFILO VIRO**



VIRO - 4 spine ridotte



SCVI4

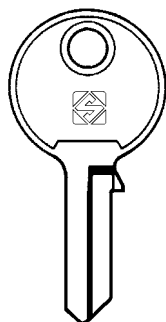

Cod.	Conf.	Prezzo
SCVI4	100	1,01 €

**CHIAVE PROFILO VIRO**



VIRO - 5 spine



SCVI8



SCVI5



SCVI5R

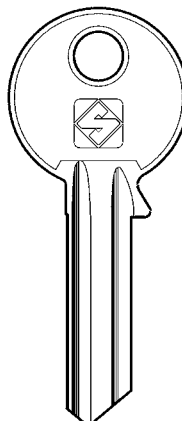

Cod.	Conf.	Prezzo
SCVI8	100	1,01 €
SCVI5	100	1,01 €
SCVI5R	100	1,01 €

**CHIAVE PROFILO VIRO**



VIRO - 5 spine ridotte



SCVI7R

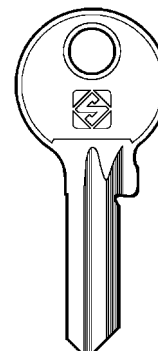

Cod.	Conf.	Prezzo
SCVI7R	100	1,06 €



**CHIAVE PROFILO VIRO**



VIRO - 5 spine



SCVI13

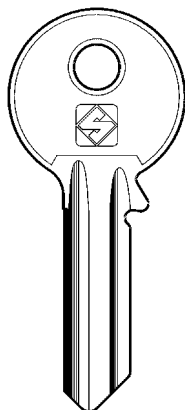

Cod.	Conf.	Prezzo
SCVI13	100	1,06 €

**CHIAVE PROFILO WALLY**



WALLY - 5 spine



SCWA1

SCWA1r

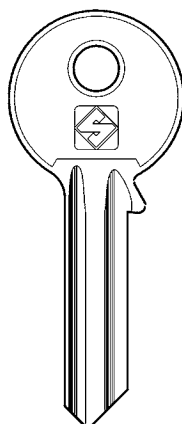

Cod.	Conf.	Prezzo
SCWA1	100	1,01 €
SCWA1R	100	0,71 €

**CHIAVE PROFILO WALLY**



WALLY - 4 spine



SCWA2

SCWA2r

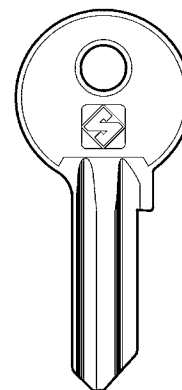

Cod.	Conf.	Prezzo
SCWA2	100	1,01 €
SCWA2R	100	0,71 €

**CHIAVE PROFILO WELKA**



WELKA - 5 spine



SCWE1

SCWE1r

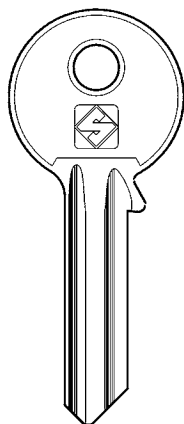

Cod.	Conf.	Prezzo
SCWE1	100	0,71 €
SCWE1R	100	0,71 €

**CHIAVE PROFILO WELKA**



WELKA - 4 spine



SCWE2

SCWE2r

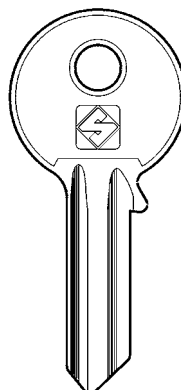

Cod.	Conf.	Prezzo
SCWE2	100	0,71 €
SCWE2R	100	0,71 €

**CHIAVE PROFILO WELKA**



WELKA - 5 spine ridotte



SCWE3

SCWE3r

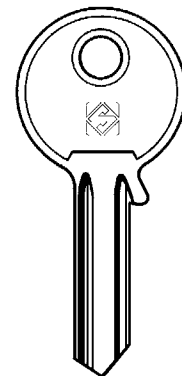

Cod.	Conf.	Prezzo
SCWE3	100	0,71 €
SCWE3R	100	0,71 €

**CHIAVE PROFILO YALE**



YALE - 4 spine ridotte



SCYA13

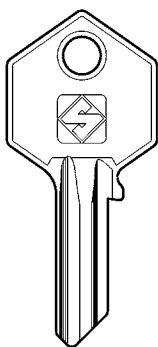

Cod.	Conf.	Prezzo
SCYA13	100	1,01 €

**CHIAVE PROFILO YALE**



YALE - 4 spine ridotte



SCYA14R

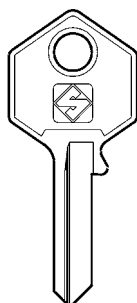

Cod.	Conf.	Prezzo
SCYA14R	100	1,01 €

**CHIAVE PROFILO YALE**



YALE - 5 spine



SCYA226

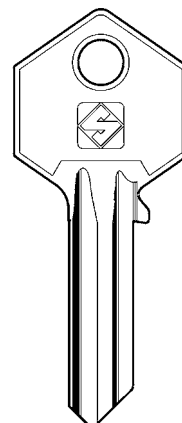

Cod.	Conf.	Prezzo
SCYA226	100	0,71 €

**CHIAVE PROFILO YALE**



YALE - 6 spine

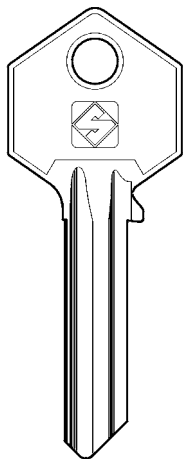

Cod.	Conf.	Prezzo
SCYA31	100	0,71 €

**CHIAVE PROFILO YALE**



YALE - 4 spine

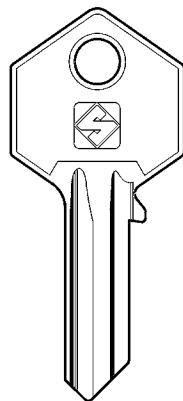

Cod.	Conf.	Prezzo
SCYA6	100	0,71 €
SCYA6R	100	1,01 €

**CHIAVE PROFILO YALE**



YALE - 5 spine ridotte

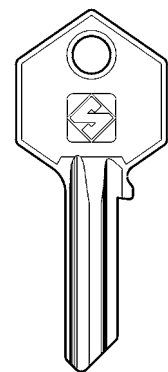

Cod.	Conf.	Prezzo
SCYA7	100	1,01 €
SCYA7R	100	1,01 €

**CHIAVE SILKY COLOR UNIVERSALE**



5 spine  
Color mix: rosso, blu, verde, arancione, viola.

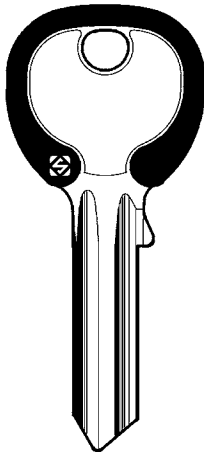

Cod.	Pz	Conf.	Prezzo
SAUL050DZ	100	1	83,20 €
SAUL051DZ	100	1	83,20 €

**CHIAVE SILKY COLOR UNIVERSALE**



4 spine  
Color mix: rosso, blu, verde, arancione, viola.

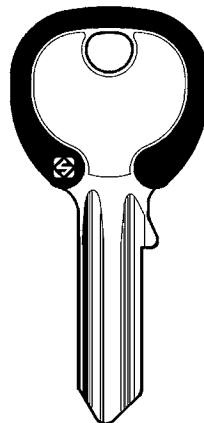

Cod.	Pz	Conf.	Prezzo
SAUL052DZ	100	1	83,20 €
SAUL053DZ	100	1	83,20 €

**CHIAVE SILKY COLOR UNIVERSALE**



6 spine  
Color mix: rosso, blu, verde, arancione, viola.

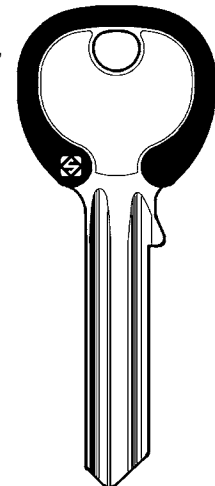

Cod.	Pz	Conf.	Prezzo
SAUL054DZ	100	1	83,20 €

**CHIAVE SILKY COLOR UNIVERSALE**



5 spine ridotte  
Color mix: rosso, blu, verde, arancione, viola.

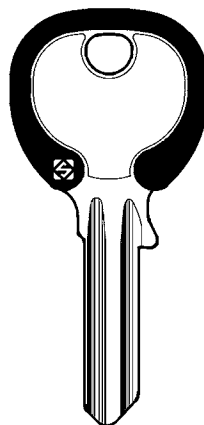

Cod.	Pz	Conf.	Prezzo
SAUL058DZ	100	1	83,20 €
SAUL059DZ	100	1	83,20 €

**CHIAVE SILKY COLOR PROF. AGB**



AGB - 5 spine  
Color mix: rosso, blu, verde, arancione, viola.

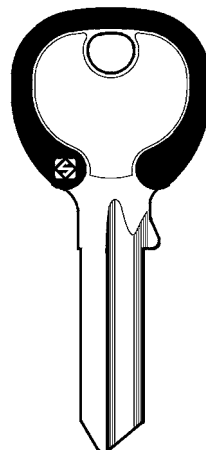

Cod.	Pz	Conf.	Prezzo
SAAGB1RDZ	100	1	120,50 €

**CHIAVE SILKY COLOR PROF. CORBIN**



CORBIN - 5 spine  
Color mix: rosso, blu, verde, arancione, viola.

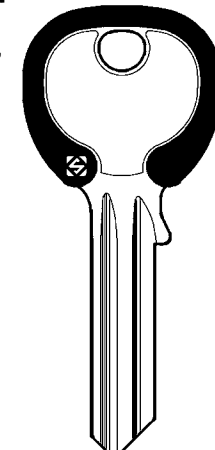

Cod.	Pz	Conf.	Prezzo
SACB6DZ	100	1	120,50 €

**CHIAVE SILKY COLOR  
PROF. CISA**

CISA - 4 spine  
Color mix: rosso, blu,  
verde, arancione,  
viola.

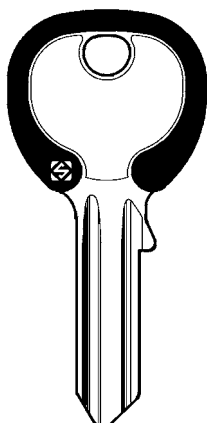

**SACS204DZ**

Cod.	Pz	Conf.	Prezzo
<b>SACS204DZ</b>	100	1	120,50 €

**CHIAVE SILKY COLOR  
PROF. CISA**

CISA - 5 spine  
Color mix: rosso, blu,  
verde, arancione,  
viola.

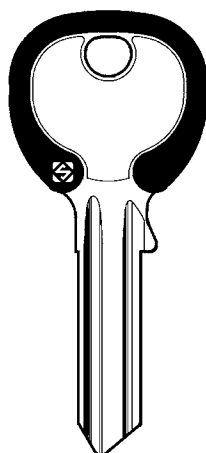

**SACS206DZ**

Cod.	Pz	Conf.	Prezzo
<b>SACS206DZ</b>	100	1	120,50 €

**CHIAVE SILKY COLOR  
PROF. CISA**

CISA - 5 spine ridotte  
Color mix: rosso, blu,  
verde, arancione,  
viola.

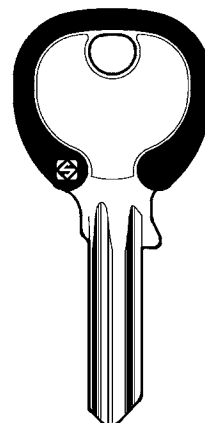

**SACS7DZ**

Cod.	Pz	Conf.	Prezzo
<b>SACS7DZ</b>	100	1	120,50 €

**CHIAVE SILKY COLOR  
PROF. FASEM**

FASEM - 5 spine  
Color mix: rosso, blu,  
verde, arancione,  
viola.

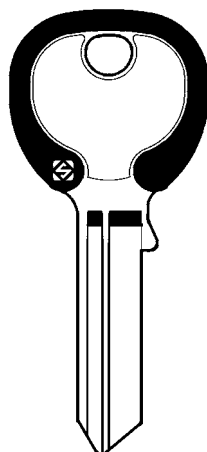

**SAFM090DZ**

Cod.	Pz	Conf.	Prezzo
<b>SAFM090DZ</b>	100	1	120,50 €

**CHIAVE SILKY COLOR  
PROF. ISEO**

ISEO - 5 spine  
Color mix: rosso, blu,  
verde, arancione,  
viola.

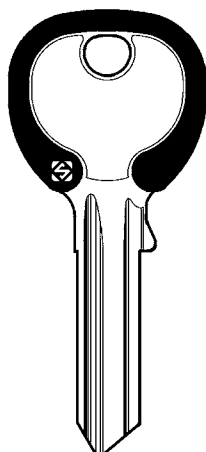

**SAIE6DZ**

Cod.	Pz	Conf.	Prezzo
<b>SAIE6DZ</b>	100	1	120,50 €

**CHIAVE SILKY COLOR  
PROF. MERONI**

MERONI - 5 spine  
Color mix: rosso, blu,  
verde, arancione,  
viola.

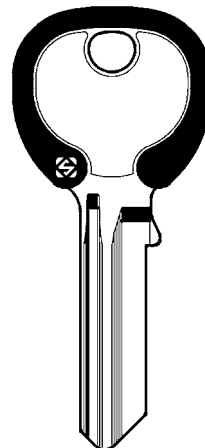

**SAMER8DZ**

Cod.	Pz	Conf.	Prezzo
<b>SAMER8DZ</b>	100	1	120,50 €

**CHIAVE SILKY COLOR  
PROF. OMEC**

VIRO - 5 spine ridotte  
Color mix: rosso, blu,  
verde, arancione,  
viola.

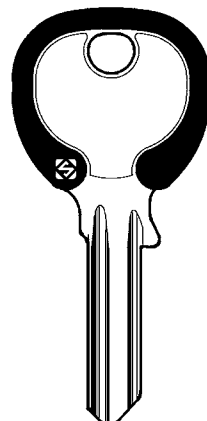

**SAOC074DZ**

Cod.	Pz	Conf.	Prezzo
<b>SAOC074DZ</b>	100	1	120,50 €

**CHIAVE SILKY COLOR  
PROF. PREFER**

VIRO - 5 spine  
Color mix: rosso, blu,  
verde, arancione,  
viola.

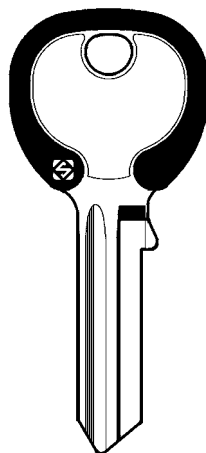

**SAFP092DZ**

**SAFP092SDZ**

Cod.	Pz	Conf.	Prezzo
<b>SAFP092DZ</b>	100	1	120,50 €
<b>SAFP092SDZ</b>	100	1	120,50 €

**CHIAVE SILKY COLOR  
PROF. VIRO**

VIRO - 5 spine  
Color mix: rosso, blu,  
verde, arancione,  
viola.

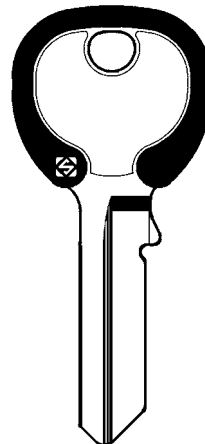

**SAVI080DZ**

**SAVI081DZ**

Cod.	Pz	Conf.	Prezzo
<b>SAVI080DZ</b>	100	1	120,50 €
<b>SAVI081DZ</b>	100	1	120,50 €

**CHIAVE SILKY COLOR  
PROF. VIRO**



VIRO - 4 spine  
Color mix: rosso, blu,  
verde, arancione,  
viola.

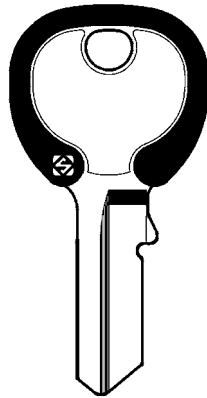

**SAVI082DZ**

Cod.	Pz	Conf.	Prezzo
SAVI082DZ	100	1	120,50 €

**CHIAVE SILKY COLOR  
PROF. VIRO**



VIRO - 4 spine ridotte  
Color mix: rosso, blu,  
verde, arancione,  
viola.

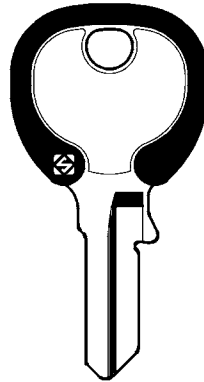

**SAVI084DZ**

Cod.	Pz	Conf.	Prezzo
SAVI084DZ	100	1	120,50 €

**CHIAVE SILKY COLOR  
PROF. VIRO**



VIRO - 5 spine ridotte  
Color mix: rosso, blu,  
verde, arancione,  
viola.

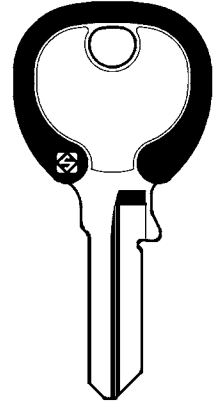

**SAVI086DZ**

Cod.	Pz	Conf.	Prezzo
SAVI086DZ	100	1	120,50 €

**CHIAVE SILKY COLOR  
PROF. WALLY**



VIRO - 5 spine  
Color mix: rosso, blu,  
verde, arancione,  
viola.

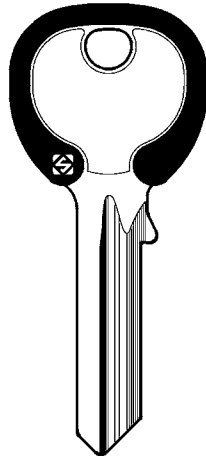

**SAWA1RDZ**

Cod.	Pz	Conf.	Prezzo
SAWA1RDZ	100	1	111,50 €

**CHIAVE SILKY COLOR  
PROF. WELKA**



WELKA - 5 spine  
Color mix: rosso, blu,  
verde, arancione,  
viola.

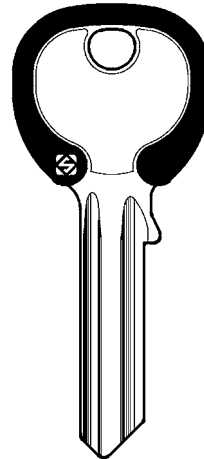

**SAWE1DZ**

Cod.	Pz	Conf.	Prezzo
SAWE1DZ	100	1	120,50 €

**CHIAVE SILKY COLOR  
PROF. YALE**



YALE - 6 spine  
Color mix: rosso, blu,  
verde, arancione,  
viola.

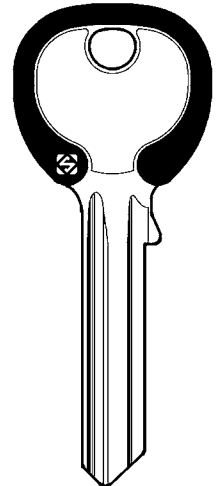

**SAYA31DZ**

Cod.	Pz	Conf.	Prezzo
SAYA31DZ	100	1	120,50 €

**CHIAVE SILKY NEW  
COLOR**



Colori assortiti:  
nero, verde, giallo,  
blu, viola.

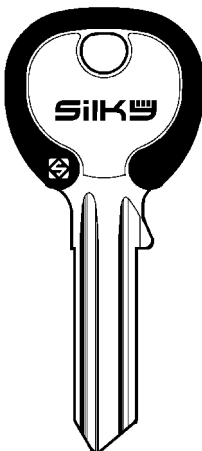

- SACS206DZ1**
- SAUL050DZ1**
- SAUL051DZ1**
- SAUL052DZ1**
- SAUL058DZ1**

Cod.	Pz	Conf.	Prezzo
SACS206DZ1	100	1	105,50 €
SAUL050DZ1	100	1	106,50 €
SAUL051DZ1	100	1	106,50 €
SAUL052DZ1	100	1	106,50 €
SAUL058DZ1	100	1	106,50 €

**CHIAVE SILKY BLU**



**SCUL050DZB**

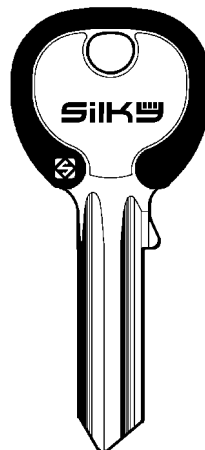

Cod.	Pz	Conf.	Prezzo
SCUL050DZB	50	1	45,98 €

**CHIAVE SILKY ROSSO**



**SCUL050DZ**

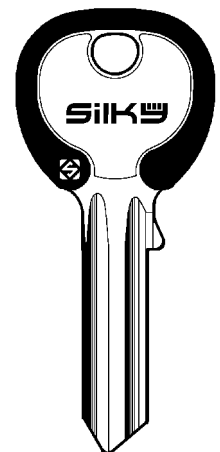

Cod.	Pz	Conf.	Prezzo
SCUL050DZ	50	1	0,92 €

**CHIAVE SILKY COLOR CISA**

CISA - colori assortiti.

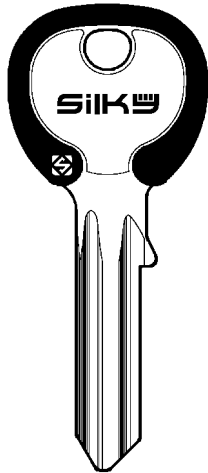

SACS119DZ

Cod.	Conf.	Conf.	Prezzo
SACS119DZ	100	1	105,50 €

**CHIAVE COLOR SLIM FLUO UNIVERSALE**

UNIVERSALE  
Testa tipo N - 5 spine ridotte  
Colori assortiti: rosso, verde, blu, arancio.

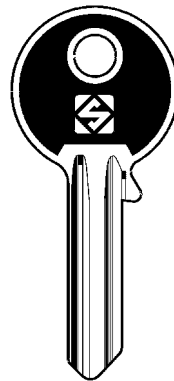

SAUL058SL

Cod.	Conf.	Prezzo
SAUL058SL	100	1,27 €

**CHIAVE COLOR SLIM FLUO UNIVERSALE**

UNIVERSAE  
Testa tipo L - 5 spine  
Colori assortiti: rosso, verde, blu, arancio.

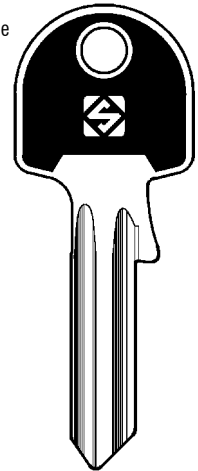

- SAUL050SLSL
- SAUL051SLSL
- SAUL052SLSL
- SAUL053SLSL
- SAUL058SLSL

Cod.	Conf.	Prezzo
SAUL050SLSL	100	1,27 €
SAUL051SLSL	100	1,27 €
SAUL052SLSL	100	1,27 €
SAUL053SLSL	100	1,27 €
SAUL058SLSL	100	1,27 €

**CHIAVE COLOR SLIM FLUO AGB**

AGB - 5 spine  
Colori assortiti: rosso, verde, blu, arancio.

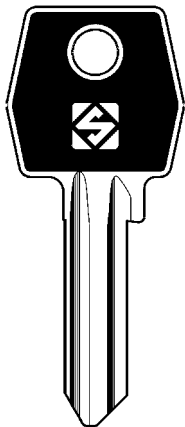

SAAGB1RSL

Cod.	Conf.	Prezzo
SAAGB1RSL	100	1,27 €

**CHIAVE COLOR SLIM FLUO CISA**

CISA - 5 spine  
Colori assortiti: rosso, verde, blu, arancio.

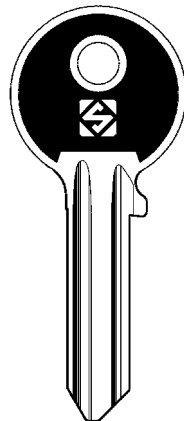

SACS206ASL

Cod.	Conf.	Prezzo
SACS206ASL	100	1,27 €

**CHIAVE COLOR SLIM FLUO CORBIN**

CORBIN - 5 spine  
Colori assortiti: rosso, verde, blu, arancio.

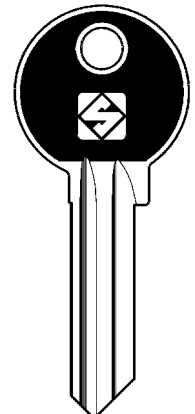

SACB6ASL

Cod.	Conf.	Prezzo
SACB6ASL	100	1,27 €

**CHIAVE COLOR SLIM FLUO ISEO**

ISEO - 5 pine  
Colori assortiti: rosso, verde, blu, arancio.

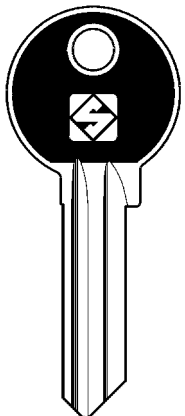

SAIE6ASL

Cod.	Conf.	Prezzo
SAIE6ASL	100	1,27 €

**CHIAVE COLOR SLIM FLUO MERONI**

MERONI - 4 spine ridotte  
Colori assortiti: rosso, verde, blu, arancio.

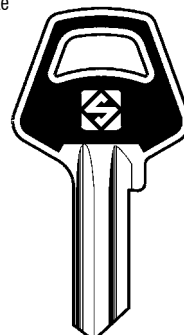

SAMER1SL

Cod.	Conf.	Prezzo
SAMER1SL	100	1,27 €

**CHIAVE COLOR SLIM FLUO OMEC**

OMEC - 5 spine ridotte  
Colori assortiti: rosso, verde, blu, arancio.

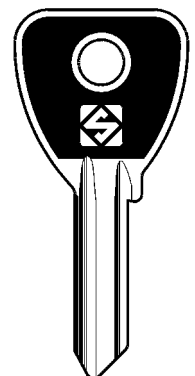

SAOC074SL

Cod.	Conf.	Prezzo
SAOC074SL	100	1,27 €

**CHIAVE SLIM FLUO VIRO**



VIRO -  
Colori assortiti:  
rosso, verde, blu,  
arancio.

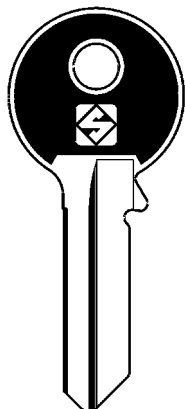

SAVI080SL

Cod.	Conf.	Prezzo
SAVI080SL	100	1,27 €

**CHIAVE COLOR SLIM FLUO VIRO**



VIRO - 4 spine  
Colori assortiti:  
rosso, verde, blu,  
arancio.

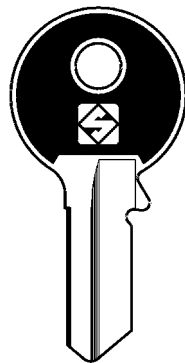

SSAVI082SL

Cod.	Conf.	Prezzo
SAVI082SL	100	1,27 €

**CHIAVE COLOR SLIM FLUO VIRO**



VIRO - 5 spine ridotte  
Colori assortiti:  
rosso, verde, blu,  
arancio.

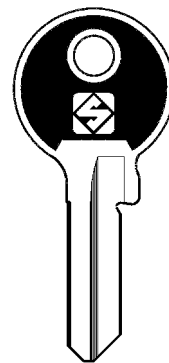

SAVI086NSL

Cod.	Conf.	Prezzo
SAVI086NSL	100	1,27 €

**CHIAVE COLOR SLIM FLUO YALE**



YALE - 6 spine  
Colori assortiti:  
rosso, verde, blu,  
arancio.

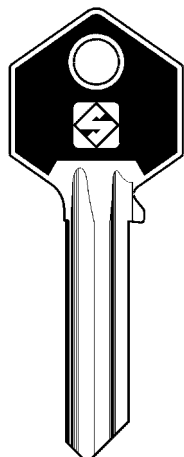

SAYA31SL

Cod.	Conf.	Prezzo
SAYA31SL	100	1,27 €

**CHIAVE PROFILO ULTRALITE UNIVERSALE**



UNIVERSALE  
5 spine -  
Colori assortiti.

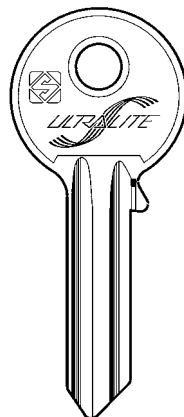

SAUL050U

Cod.	Conf.	Prezzo
SAUL050U	100	181,50 €

**CHIAVE PROFILO ULTRALITE CISA**



CISA 5 spine -  
Colori assortiti.

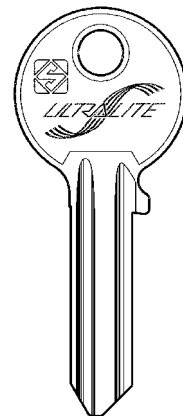

SACS206U

Cod.	Conf.	Prezzo
SACS206U	100	196,00 €

**CHIAVE PROFILO ULTRALITE OMEC**



OMEC 5 spine ridotte -  
Colori assortiti.

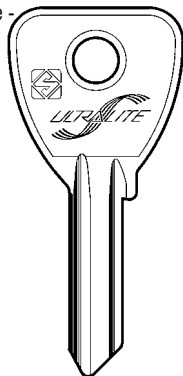

SAOC074U

Cod.	Conf.	Prezzo
SAOC074U	100	196,00 €

**CHIAVE PROFILO ULTRALITE VIRO**



VIRO 5 spine -  
Colori assortiti.

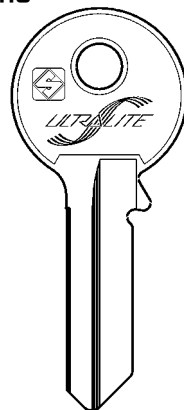

SAVI080U

Cod.	Conf.	Prezzo
SAVI080U	100	196,00 €

**CHIAVE DOPPIA MAPPA  
ANTONIOLI**

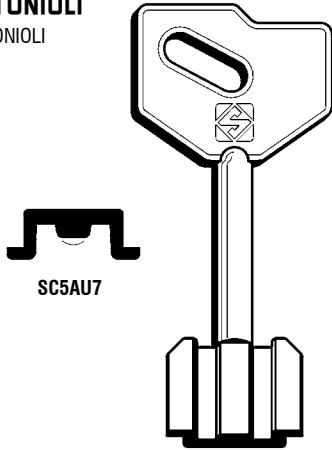

SC5AU7

Cod.	Conf.	Prezzo
SC5AU7	25	4,35 €

**CHIAVE DOPPIA MAPPA  
ATRA**

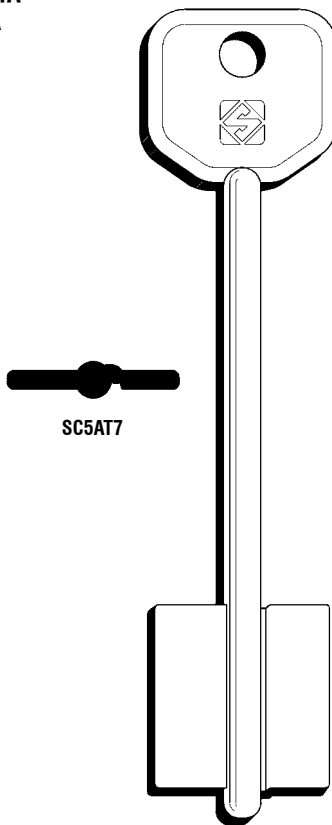

SC5AT7

Cod.	Conf.	Prezzo
SC5AT7	25	5,08 €

**CHIAVE DOPPIA MAPPA  
ATRA**

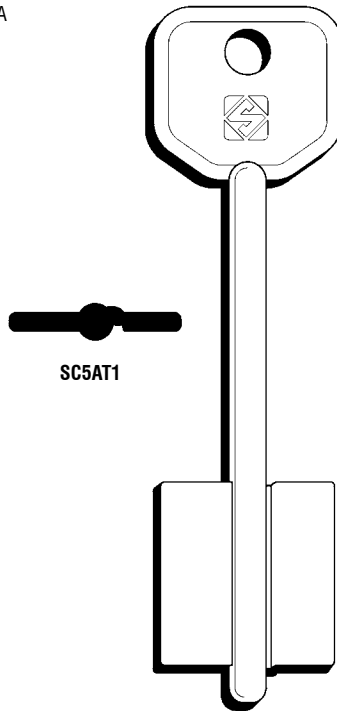

SC5AT1

Cod.	Conf.	Prezzo
SC5AT1	25	3,75 €

**CHIAVE DOPPIA MAPPA  
ATRA**

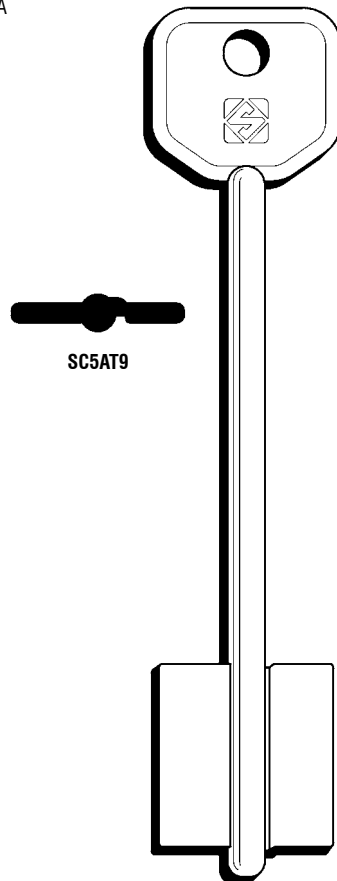

SC5AT9

Cod.	Conf.	Prezzo
SC5AT9	25	5,08 €

**CHIAVE DOPPIA MAPPA  
ATRA**

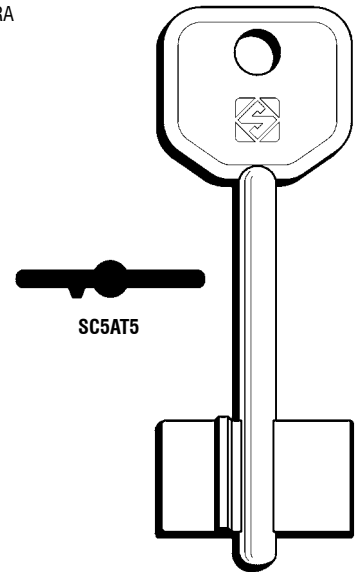

SC5AT5

Cod.	Conf.	Prezzo
SC5AT5	25	4,35 €

**CHIAVE DOPPIA MAPPA  
CAF**

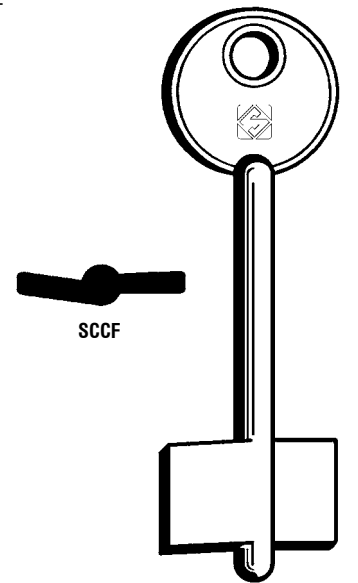

SCCF

Cod.	Conf.	Prezzo
SCCF	25	4,35 €

**CHIAVE DOPPIA MAPPA  
CERUTTI**  
CERUTTI

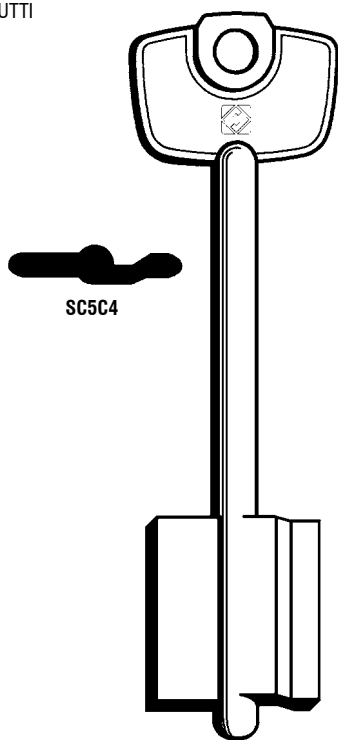

Cod.	Conf.	Prezzo
SC5C4	25	5,08 €

**CHIAVE DOPPIA MAPPA  
CERUTTI**  
CERUTTI

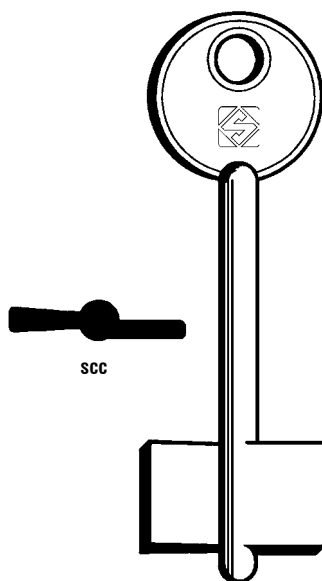

Cod.	Conf.	Prezzo
SCC	25	4,35 €

**CHIAVE DOPPIA MAPPA  
CERUTTI**  
CERUTTI

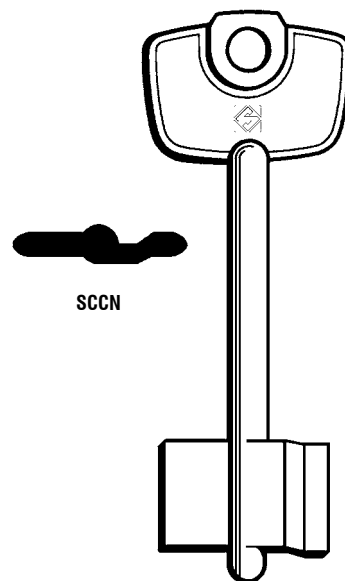

Cod.	Conf.	Prezzo
SCCN	25	5,08 €

**CHIAVE DOPPIA MAPPA  
CISA**  
CISA

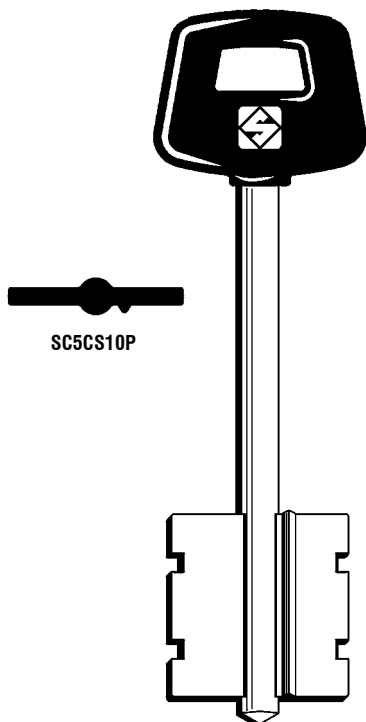

Cod.	Conf.	Prezzo
SC5CS10P	25	4,63 €

**CHIAVE DOPPIA MAPPA  
CISA**  
CISA

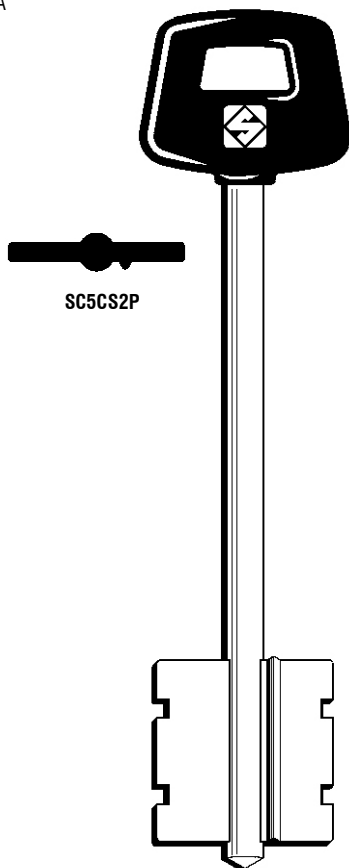

Cod.	Conf.	Prezzo
SC5CS12P	25	5,80 €

**CHIAVE DOPPIA MAPPA  
CISA**  
CISA

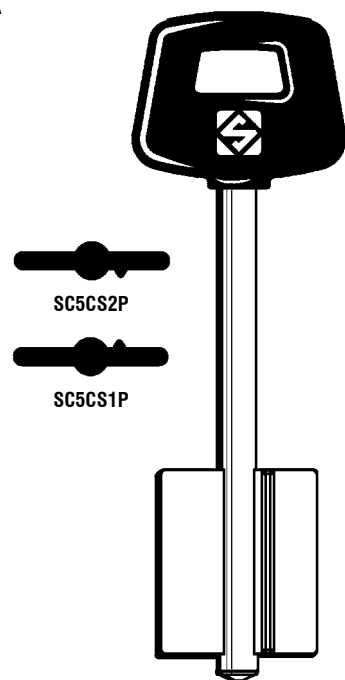

Cod.	Conf.	Prezzo
SC5CS2P	25	5,00 €
SC5CS1P	25	5,80 €



**CHIAVE DOPPIA MAPPA**  
CISA

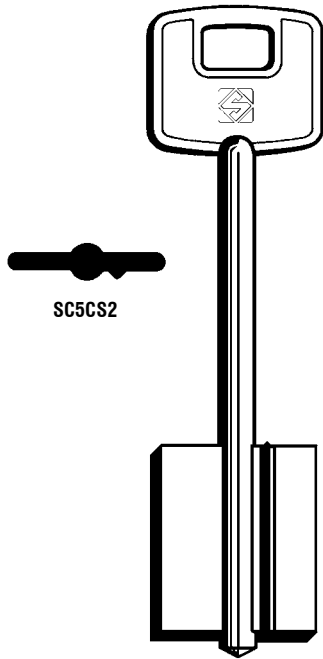

Cod.	Conf.	Prezzo
SC5CS2	25	5,08 €

**CHIAVE DOPPIA MAPPA**  
CISA

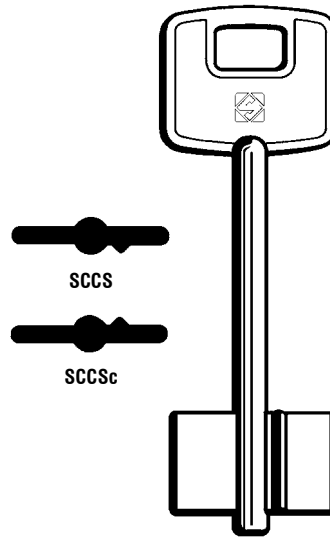

Cod.	Conf.	Prezzo
SCCS	25	3,75 €
SCCSc	25	4,35 €

**CHIAVE DOPPIA MAPPA**  
CISA

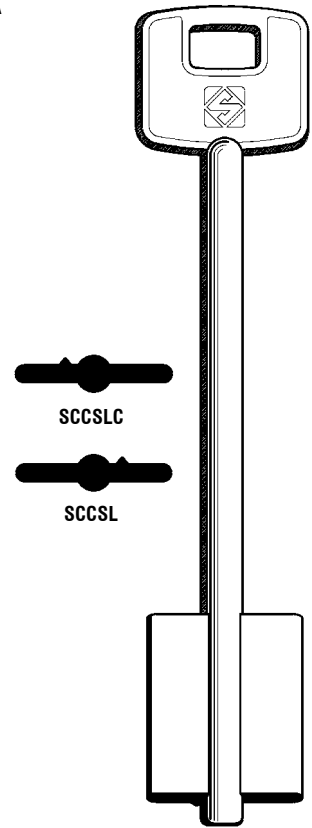

Cod.	Conf.	Prezzo
SCCSLC	25	4,37 €
SCCSL	25	5,08 €

**CHIAVE DOPPIA MAPPA**  
CISA

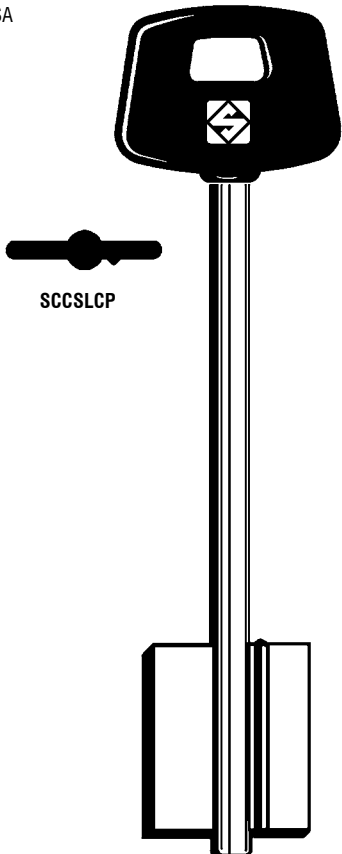

Cod.	Conf.	Prezzo
SCCSLCP	25	5,80 €

**CHIAVE DOPPIA MAPPA**  
CISA

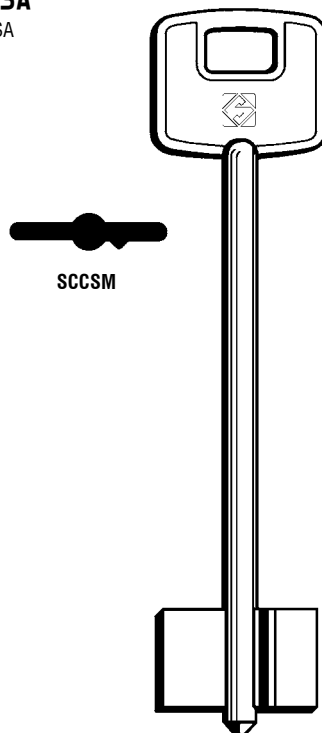

Cod.	Conf.	Prezzo
SCCSM	25	4,37 €

**CHIAVE DOPPIA MAPPA**  
CISA

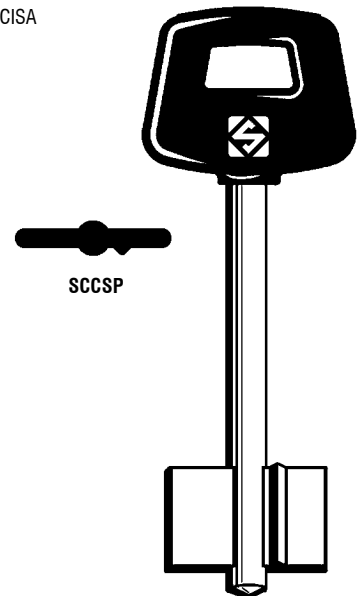

Cod.	Conf.	Prezzo
SCCSP	25	5,80 €

**CHIAVE DOPPIA MAPPA  
CONFORTI**  
CONFORTI

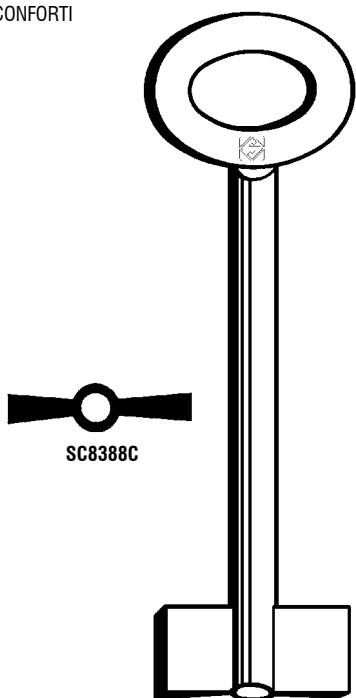

SC8388C

Cod.	Conf.	Prezzo
SC8388C	25	5,80 €

**CHIAVE DOPPIA MAPPA  
CR**  
CR

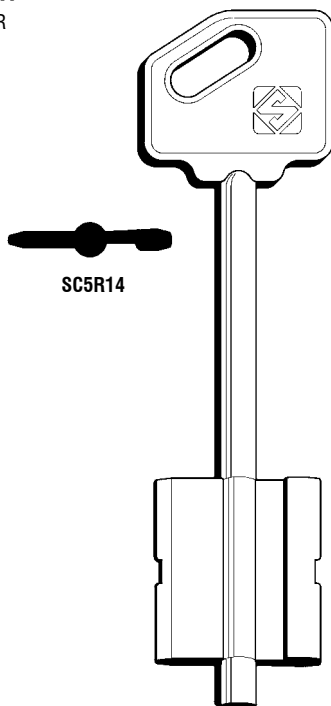

SC5R14

Cod.	Conf.	Prezzo
SC5R14	25	3,75 €

**CHIAVE DOPPIA MAPPA  
CR**  
CR

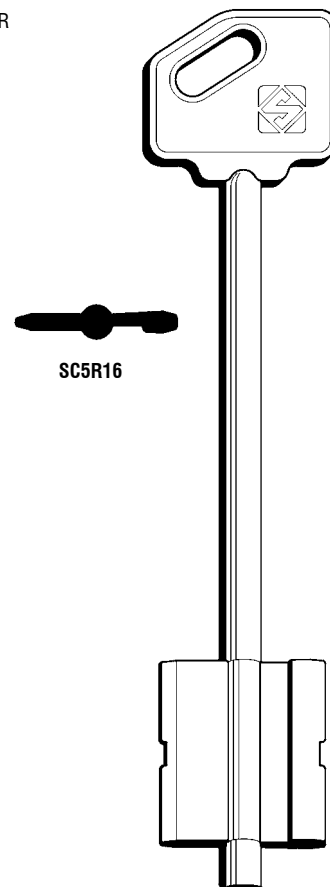

SC5R16

Cod.	Conf.	Prezzo
SC5R16	25	4,37 €

**CHIAVE DOPPIA MAPPA  
CR**  
CR

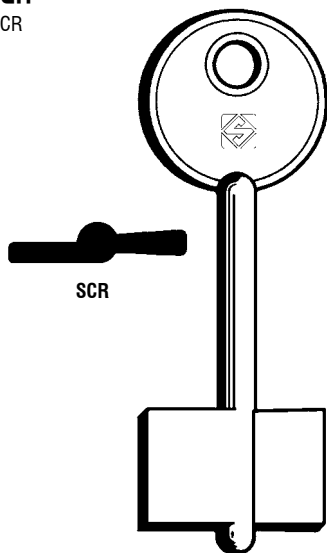

SCR

Cod.	Conf.	Prezzo
SCR	25	4,35 €

**CHIAVE DOPPIA MAPPA  
CR**  
CR

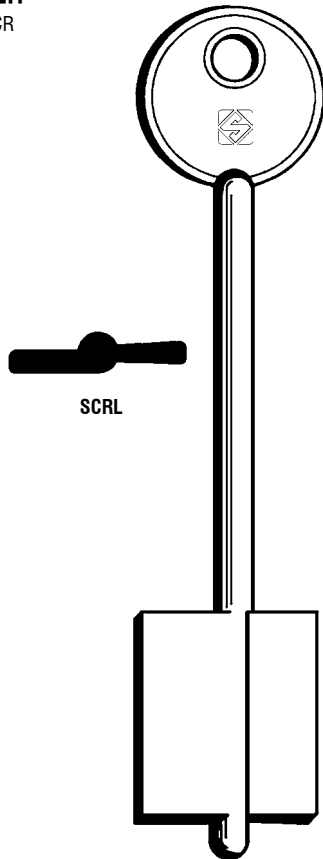

SCRL

Cod.	Conf.	Prezzo
SCRL	25	5,08 €

**CHIAVE DOPPIA MAPPA  
CR**  
CR

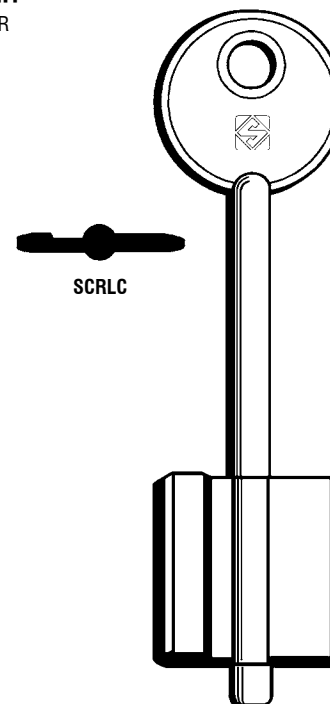

SCRLC

Cod.	Conf.	Prezzo
SCRLC	25	4,35 €

**CHIAVE DOPPIA MAPPA  
CR**  
CR

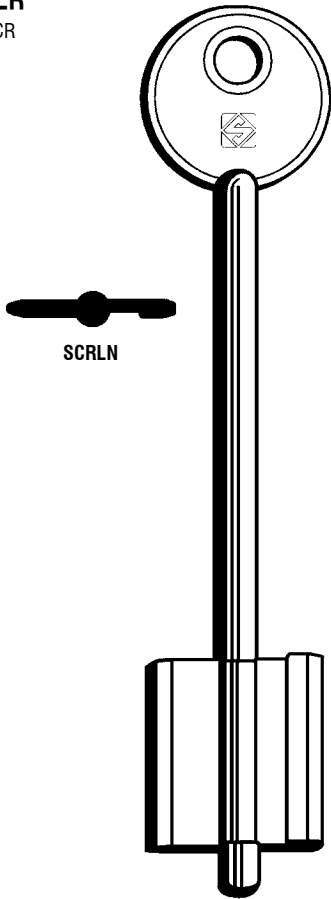

SCRLN

Cod.	Conf.	Prezzo
SCRLN	25	5,08 €

**CHIAVE DOPPIA MAPPA  
ESETY**  
ESETY

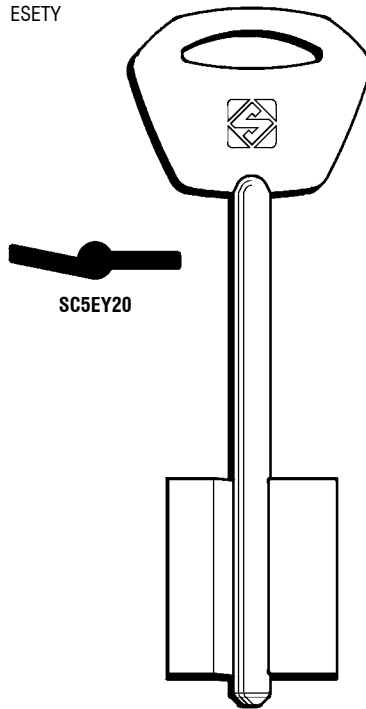

SC5EY20

Cod.	Conf.	Prezzo
SC5EY20	25	4,35 €

**CHIAVE DOPPIA MAPPA  
ESETY**  
ESETY

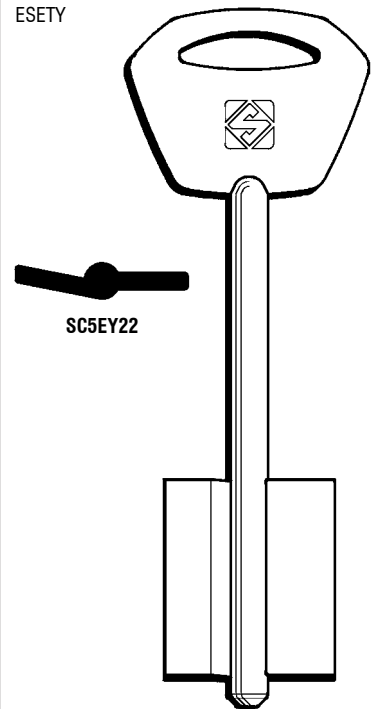

SC5EY22

Cod.	Conf.	Prezzo
SC5EY22	25	4,35 €

**CHIAVE DOPPIA MAPPA  
ESETY**  
ESETY

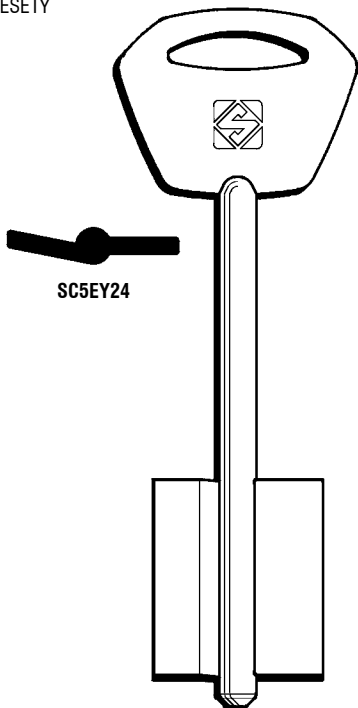

SC5EY24

Cod.	Conf.	Prezzo
SC5EY24	25	5,08 €

**CHIAVE DOPPIA MAPPA  
ESETY**  
ESETY

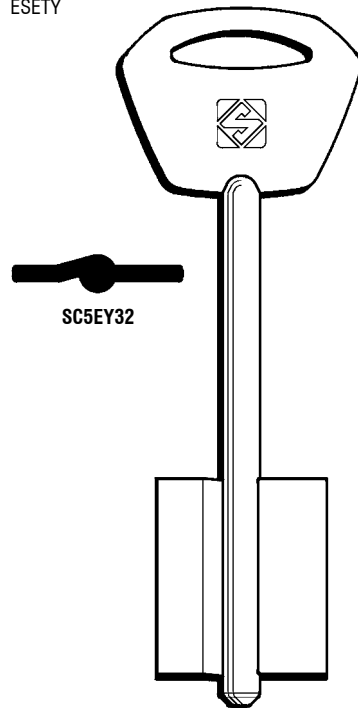

SC5EY32

Cod.	Conf.	Prezzo
SC5EY32	25	4,35 €

**CHIAVE DOPPIA MAPPA  
ESETY**  
ESETY

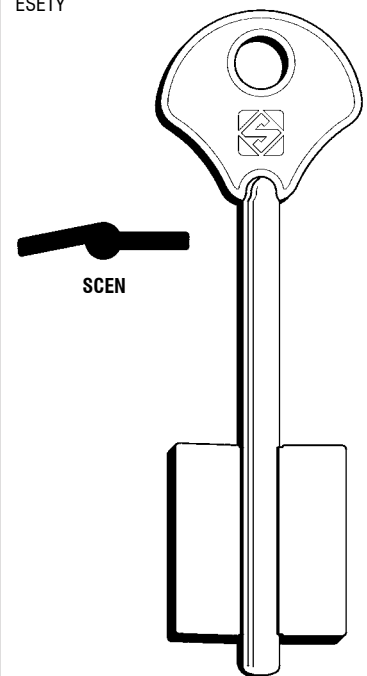

SCEN

Cod.	Conf.	Prezzo
SCEN	25	5,08 €

**CHIAVE DOPPIA MAPPA  
FIAM**

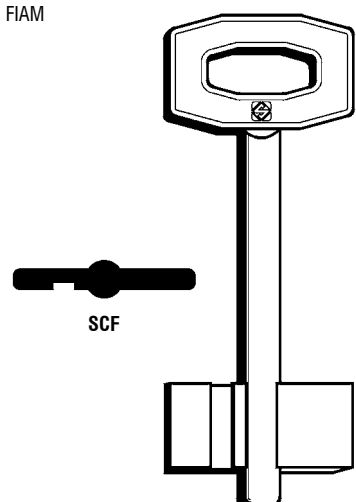

Cod.	Conf.	Prezzo
SCF	25	4,35 €

**CHIAVE A DOPPIA MAPPA  
FEB**

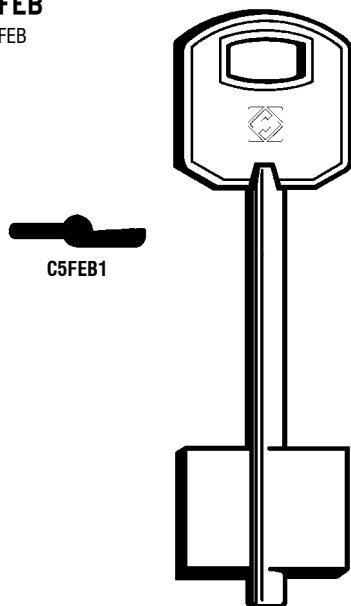

Cod.	Conf.	Prezzo
SC5FEB1	25	3,75 €

**CHIAVE DOPPIA MAPPA  
IDM**

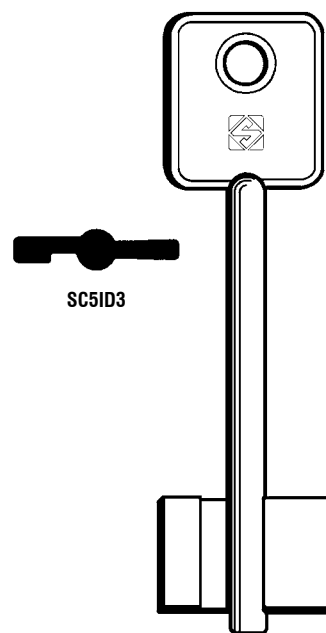

Cod.	Conf.	Prezzo
SC5ID3	25	5,08 €

**CHIAVE DOPPIA MAPPA  
IDM**

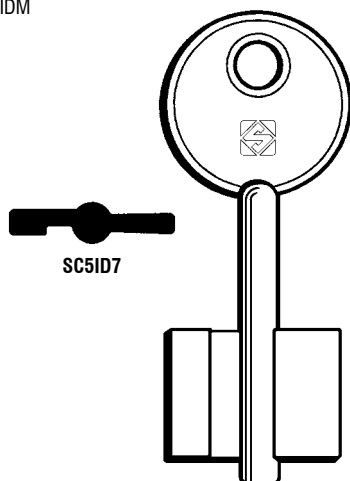

Cod.	Conf.	Prezzo
SC5ID7	25	5,08 €

**CHIAVE DOPPIA MAPPA  
ISEO**

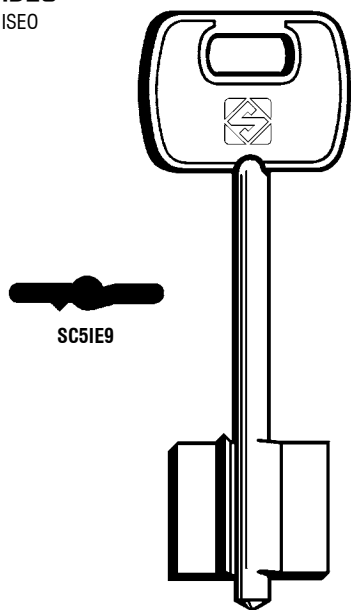

Cod.	Conf.	Prezzo
SC5IE9	25	3,75 €

**CHIAVE DOPPIA MAPPA  
JUWEL**

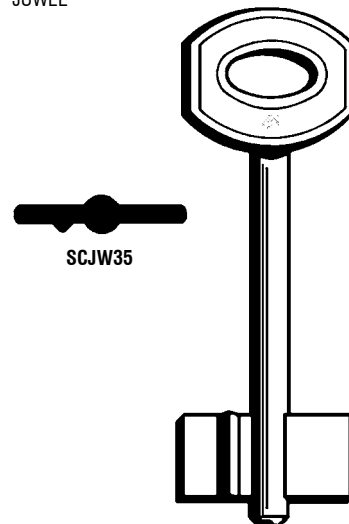

Cod.	Conf.	Prezzo
SCJW35	25	4,35 €

**CHIAVE DOPPIA MAPPA  
JUWEL**  
JUWEL

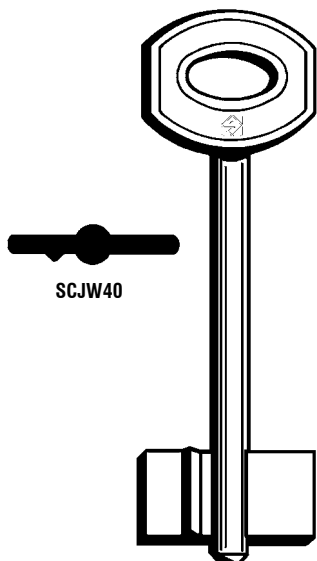

Cod.	Conf.	Prezzo
SCJW40	25	3,75 €

**CHIAVE DOPPIA MAPPA  
JUWEL**  
JUWEL

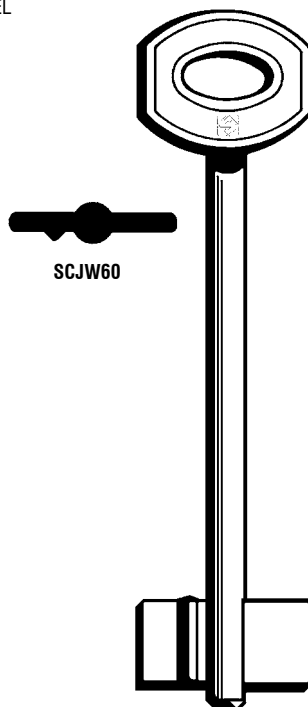

Cod.	Conf.	Prezzo
SCJW60	25	5,08 €

**CHIAVE DOPPIA MAPPA  
JUWEL**  
JUWEL

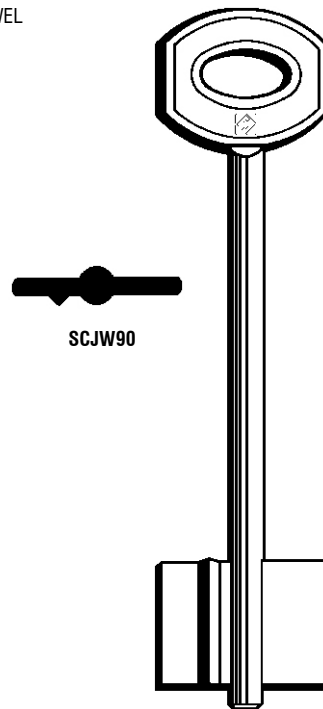

Cod.	Conf.	Prezzo
SCJW90	25	5,08 €

**CHIAVE DOPPIA MAPPA  
MOTTURA**  
MOTTURA

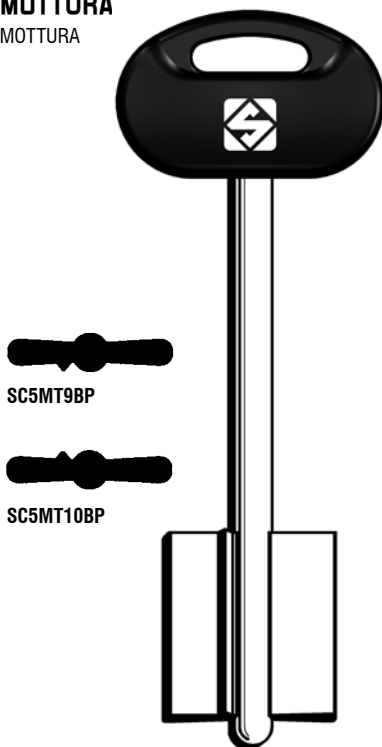

Cod.	Conf.	Prezzo
SC5MT9BP	25	5,00 €
SC5MT10BP	25	5,80 €

**CHIAVE DOPPIA MAPPA  
MOTTURA**  
MOTTURA

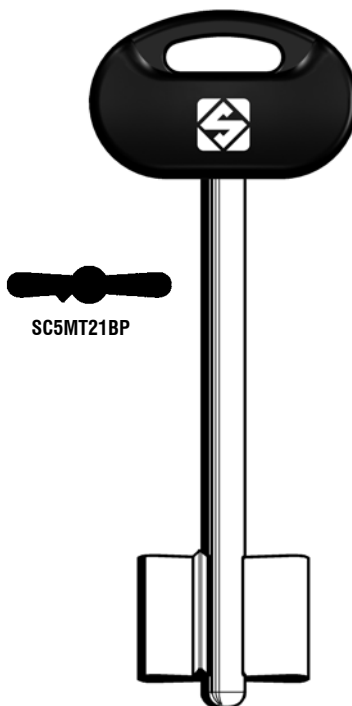

Cod.	Conf.	Prezzo
SC5MT21BP	25	5,80 €

**CHIAVE DOPPIA MAPPA  
MOTTURA**  
MOTTURA

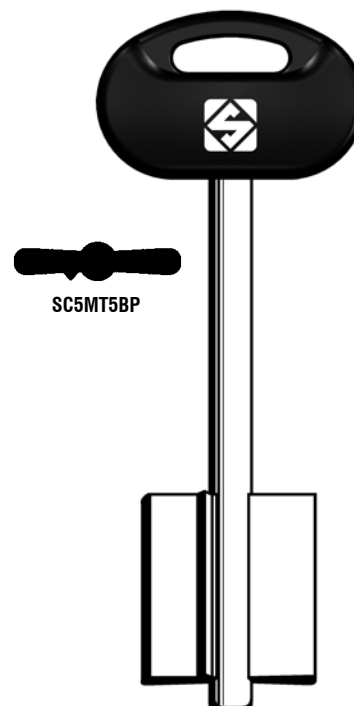

Cod.	Conf.	Prezzo
SC5MT5BP	25	5,00 €

**CHIAVE DOPPIA MAPPA  
MOTTURA**  
MOTTURA



SCMTNCBP

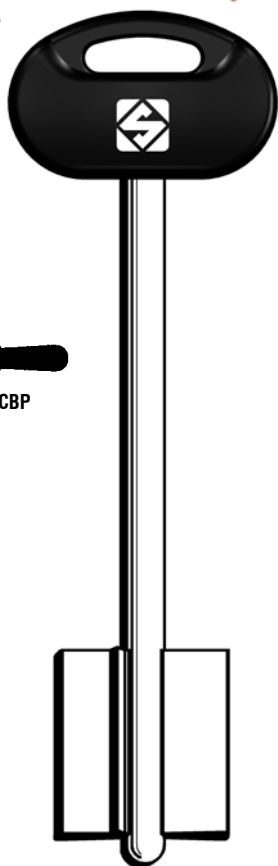

Cod.	Conf.	Prezzo
SCMTNCBP	25	5,00 €

**CHIAVE DOPPIA MAPPA  
POTENT**  
POTENT



SC5PT11

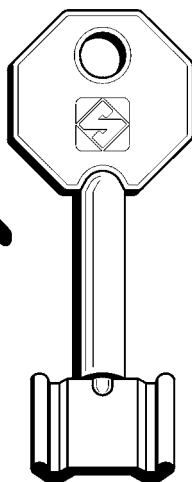

Cod.	Conf.	Prezzo
SC5PT11	25	4,35 €

**CHIAVE DOPPIA MAPPA  
POTENT**  
POTENT



SC5PT12

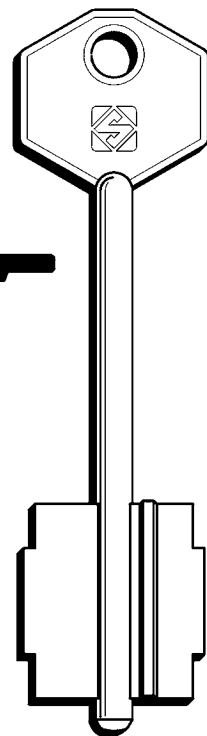

Cod.	Conf.	Prezzo
SC5PT12	25	4,37 €

**CHIAVE DOPPIA MAPPA  
POTENT**  
POTENT



SC5PT3

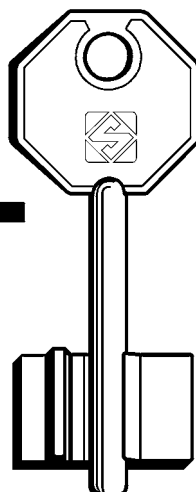

Cod.	Conf.	Prezzo
SC5PT3	25	3,75 €

**CHIAVE DOPPIA MAPPA  
POTENT**  
POTENT



SC5PT2

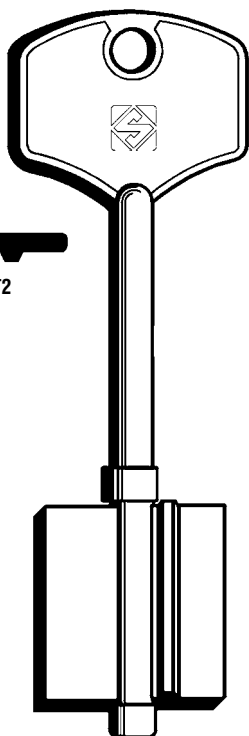

Cod.	Conf.	Prezzo
SC5PT2	25	4,37 €

**CHIAVE A DOPPIA MAPPA  
SAB**  
SAB



SC5SAB2

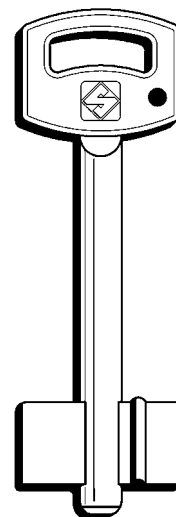

Cod.	Conf.	Prezzo
SC5SAB2	25	4,35 €

**CHIAVE DOPPIA MAPPA  
SAB**  
SAB

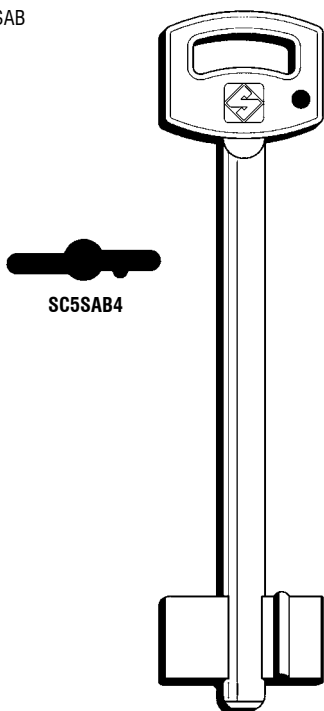

SC5SAB4

Cod.	Conf.	Prezzo
SC5SAB4	25	4,03 €

**CHIAVE DOPPIA MAPPA  
SAFE**  
SAFE

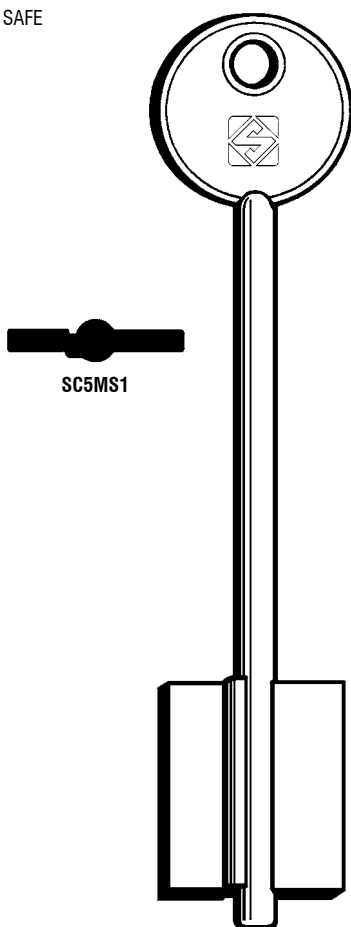

SC5MS1

Cod.	Conf.	Prezzo
SC5MS1	25	5,08 €

**CHIAVE DOPPIA MAPPA  
SAFE**  
SAFE

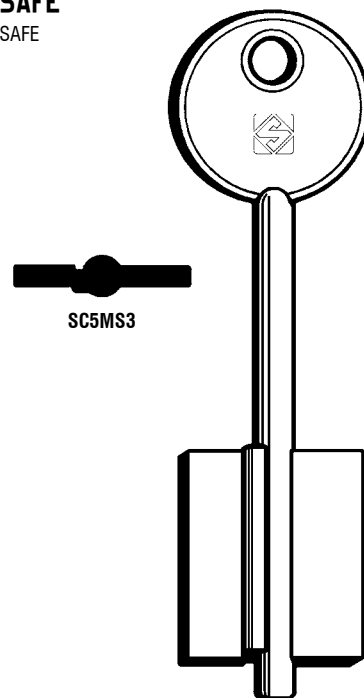

SC5MS3

Cod.	Conf.	Prezzo
SC5MS3	25	5,08 €

**CHIAVE DOPPIA MAPPA  
SECUREMME**  
SECUREMME

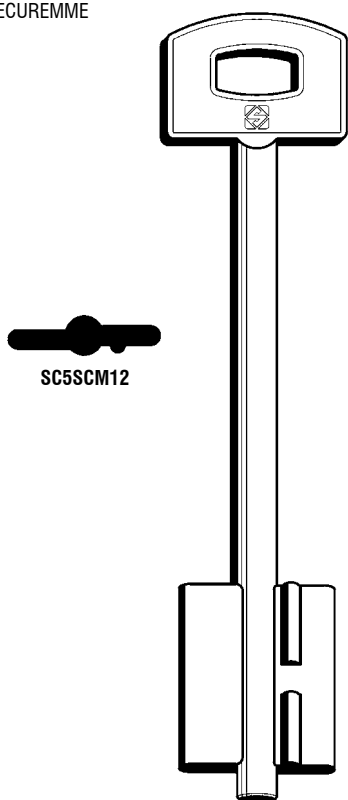

SC5SCM12

Cod.	Conf.	Prezzo
SC5SCM12	25	5,08 €

**CHIAVE DOPPIA MAPPA  
SECUREMME**  
SECUREMME

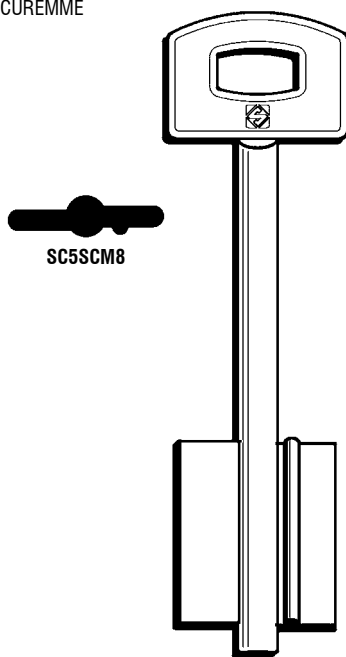

SC5SCM8

Cod.	Conf.	Prezzo
SC5SCM8	25	5,08 €

**CHIAVE DOPPIA MAPPA  
SECUREMME**  
SECUREMME

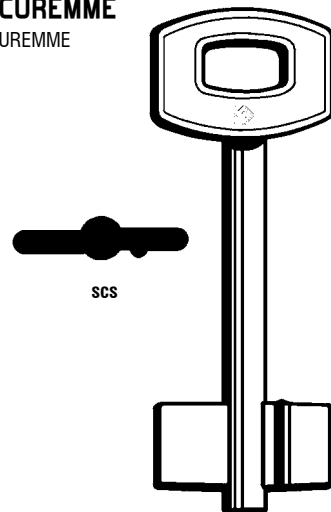

SCS

Cod.	Conf.	Prezzo
SCS	25	3,75 €

**CHIAVE PROFILO CISA  
PUNZONATA**

CISA - 6+7 spine

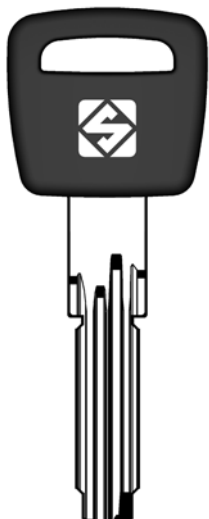

Cod.	Conf.	Prezzo
SCCS62AP	25	3,15 €
SCCS70AP	25	3,15 €

**CHIAVE PROFILO ISEO  
PUNZONATA**

ISEO - 5+6+6 spine  
Testa blu.

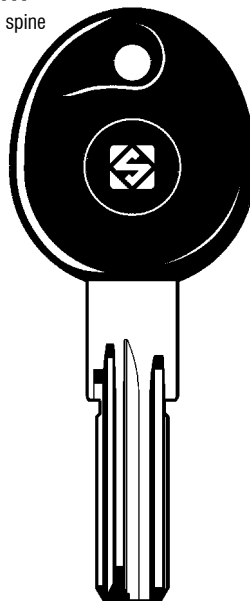

Cod.	Conf.	Prezzo
SCIE26P	25	3,15 €

**CHIAVE PROFILO  
SECUREMME PUNZONATA**

SECUREMME -  
10 spine

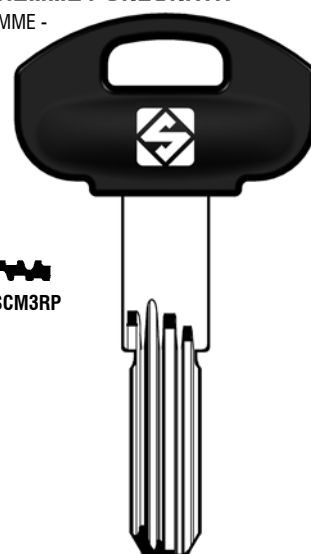

Cod.	Conf.	Prezzo
SCSCM3RP	25	3,15 €

**CHIAVE PROFILO AGB  
ALPACCA PUNZONATA**

AGB

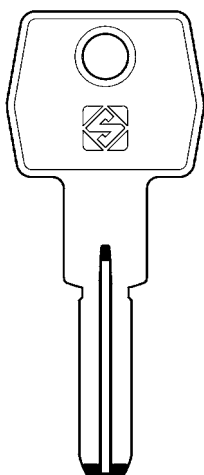

Cod.	Conf.	Prezzo
SCAGB5	50	2,42 €

**CHIAVE PROFILO  
ALPACCA PUNZONATA  
DOM**

DOM

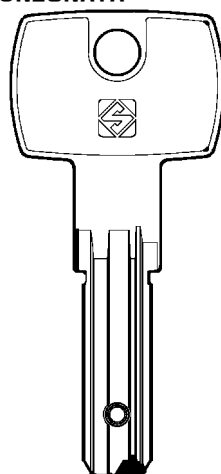

Cod.	Conf.	Prezzo
SCDM139	50	9,64 €

**CHIAVE PROFILO AGB  
PUNZONATA**

AGB - 7 spine

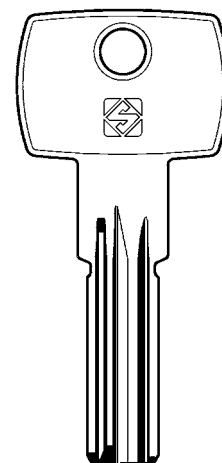

Cod.	Conf.	Prezzo
SCAGB6	50	1,82 €



**CHIAVE PROFILO AGB  
PUNZONATA**

AGB - 6 spine

**AGB**  
SCAGB7

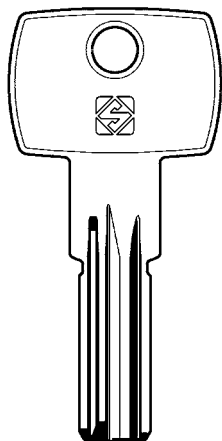

Cod.	Conf.	Prezzo
SCAGB7	50	1,82 €

**CHIAVE PROFILO AGB  
PUNZONATA**

AGB - 7 spine

**AGB**  
SCAGB8

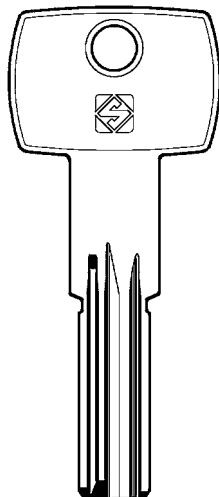

Cod.	Conf.	Prezzo
SCAGB8	50	1,82 €

**CHIAVE PROFILO AGB  
PUNZONATA**

AGB - 6 spine

**AGB**  
SCAGB9

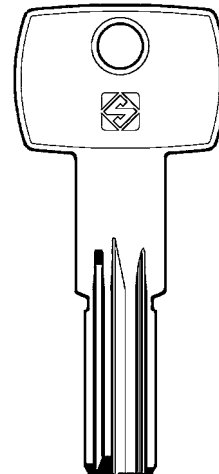

Cod.	Conf.	Prezzo
SCAGB9	50	1,82 €

**CHIAVE PROFILO CISA  
PUNZONATA**

CISA - 6+7 spine

**CISA**  
SCCS62  
SCCS115

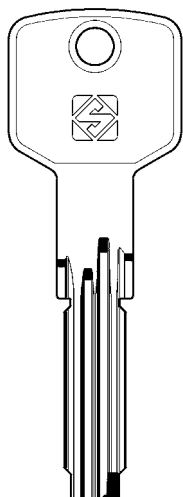

Cod.	Conf.	Prezzo
SCCS62	50	1,82 €
SCCS115	50	1,82 €

**CHIAVE PROFILO CISA  
PUNZONATA**

CISA - 6+7 spine

**CISA**  
SCCS141

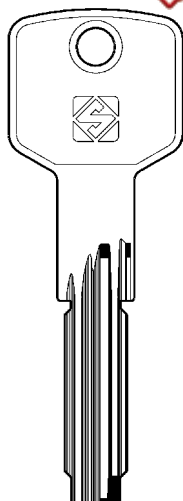

Cod.	Conf.	Prezzo
SCCS141	50	1,82 €

**CHIAVE PROFILO CISA  
PUNZONATA**

CISA

**CISA**  
SCCS146

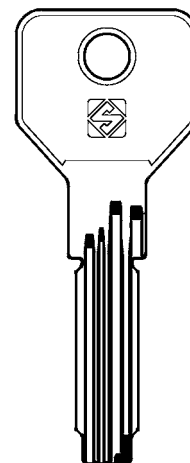

Cod.	Conf.	Prezzo
SCCS146	50	1,82 €

**CHIAVE PROFILO CISA  
PUNZONATA**

CISA - 6+6spine

**CISA**  
SCCS70

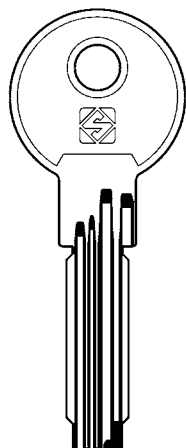

Cod.	Conf.	Prezzo
SCCS70	50	1,82 €

**CHIAVE PROFILO CORBIN  
PUNZONATA**

CORBIN - 6 spine

**CORBIN**  
SCCB87

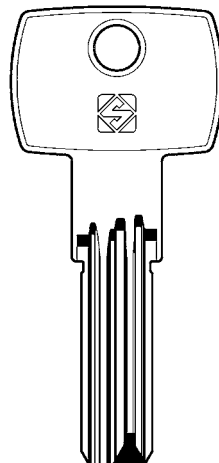

Cod.	Conf.	Prezzo
SCCB87	50	2,74 €

**CHIAVE PROFILO CORBIN  
PUNZONATA**

CORBIN - 6spine

**CORBIN**  
SCCB97

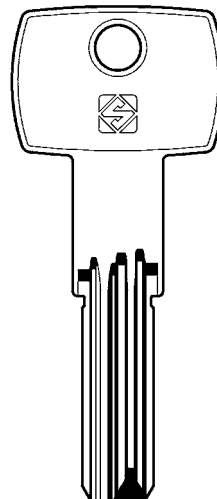

Cod.	Conf.	Prezzo
SCCB97	50	1,82 €

**CHIAVE PROFILO ISEO  
PUNZONATA**

ISEO - 5+6+6 spine



**HNH**  
SCIE14

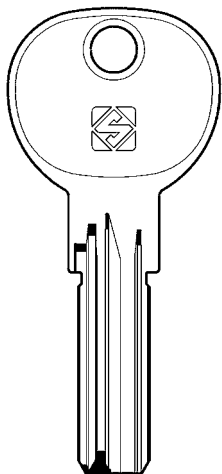

Cod.	Conf.	Prezzo
SCIE14	50	1,82 €

**CHIAVE PROFILO ISEO  
PUNZONATA**

ISEO - 5+6+6 spine



**HNH**  
SCIE15

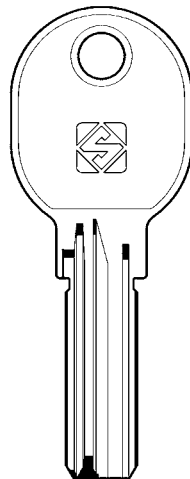

Cod.	Conf.	Prezzo
SCIE15	50	1,82 €

**CHIAVE PROFILO ISEO  
PUNZONATA**

ISEO - 5+6+6 spine



**HNH**  
SCIE26

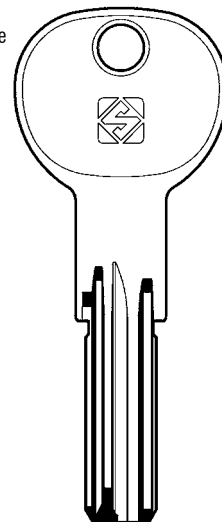

Cod.	Conf.	Prezzo
SCIE26	50	1,82 €

**CHIAVE PROFILO LINCE  
PUNZONATA**

LINCE - 5+5 spine



**HNH**  
SCLc14r

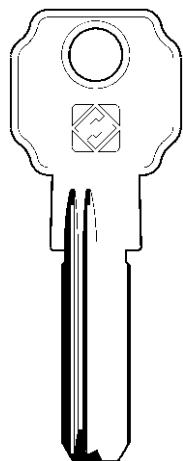

Cod.	Conf.	Prezzo
SCLC14R	50	1,82 €

**CHIAVE PROFILO OMEC  
PUNZONATA**

OMEC - 6 spine



**HNH**  
SCOC3

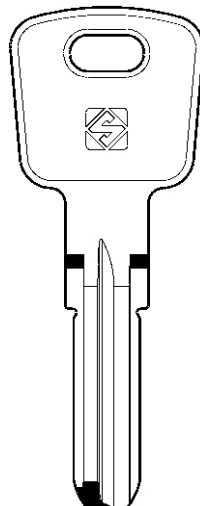

Cod.	Conf.	Prezzo
SCOC3	50	2,74 €

**CHIAVE PROFILO OMEC  
PUNZONATA**

OMEC - 6 spine



**HNH**  
SCOC4

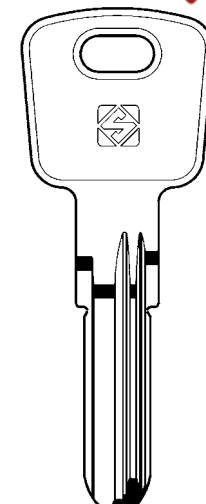

Cod.	Conf.	Prezzo
SCOC4	50	2,74 €

**CHIAVE PROFILO OMEC  
PUNZONATA**

OMEC - 6 spine



**HNH**  
SCOC6

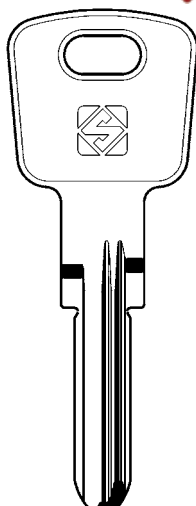

Cod.	Conf.	Prezzo
SCOC6	50	2,74 €

**CHIAVE PROFILO MG  
(MONTI) PUNZONATA**

MG (MONTI) -  
5+5+5 spine



**HNH**  
SCMG8

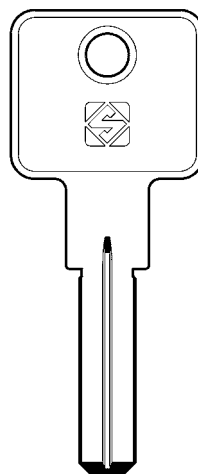

Cod.	Conf.	Prezzo
SCMG8	50	2,74 €

**CHIAVE PROFILO MG  
(MONTI) PUNZONATA**

MG (MONTI) -  
5+4 spine



**HNH**  
SCMG9

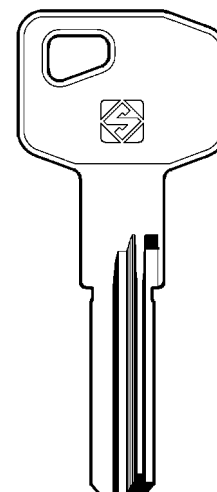

Cod.	Conf.	Prezzo
SCMG9	50	2,74 €

**CHIAVE PROFILO POTENT  
PUNZONATA**

POTENT



**SCPT4R**

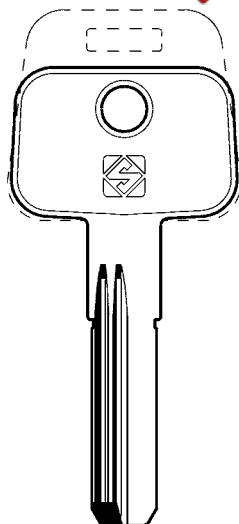

Cod.	Conf.	Prezzo
SCPT4R	50	1,82 €

**CHIAVE PROFILO  
SECUREMME PUNZONATA**

SECUREMME - 10 spine



**SCSCM1R**

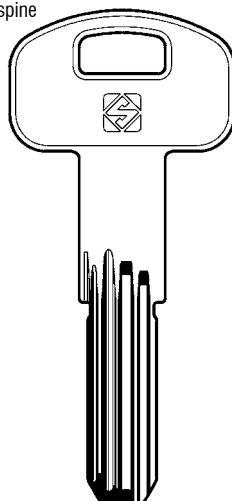

Cod.	Conf.	Prezzo
SCSCM1R	50	1,82 €

**CHIAVE PROFILO  
SECUREMME PUNZONATA**

SECUREMME  
10 spine



**SCSCM2**

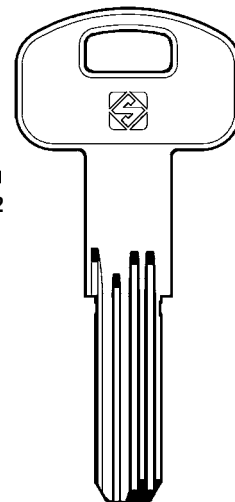

Cod.	Conf.	Prezzo
SCSCM2	50	2,74 €

**CHIAVE PROFILO TESA  
PUNZONATA**

TESA - 5+5 spine



**SCTE7**

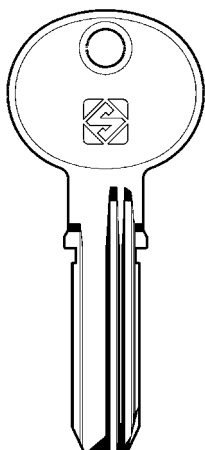

Cod.	Conf.	Prezzo
SCTE7	50	2,74 €

**CHIAVE PROFILO VIRO  
PUNZONATA**

VIRO



**SCVI19**

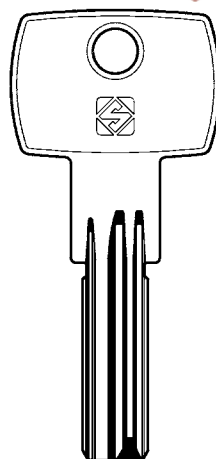

Cod.	Conf.	Prezzo
SCVI19	50	2,74 €

**CHIAVE PROFILO  
YALE**

YALE - 6 spine



**SCYA91**

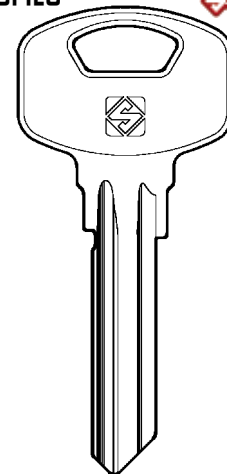

Cod.	Conf.	Prezzo
SCYA91	50	0,74 €



CHIAVE PATENT



PATENT

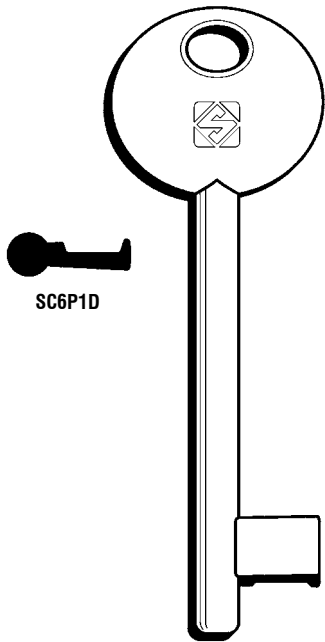

SC6P1D

Cod.	Conf.	Prezzo
SC6P1D	25	3,31 €

CHIAVE PATENT



PATENT

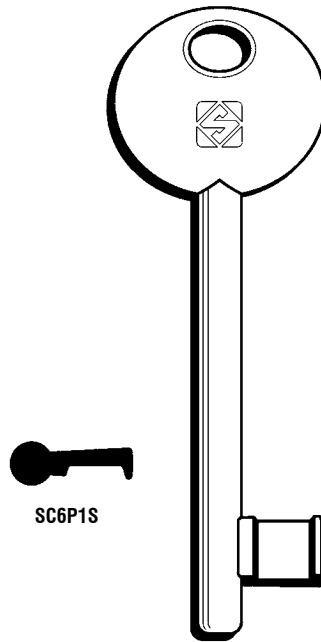

SC6P1S

Cod.	Conf.	Prezzo
SC6P1S	25	3,31 €

CHIAVE PATENT



PATENT

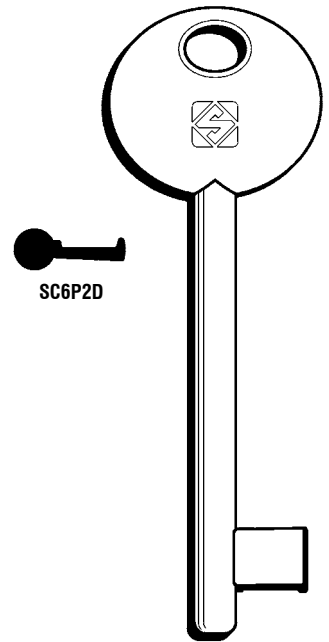

SC6P2D

Cod.	Conf.	Prezzo
SC6P2D	25	3,31 €

CHIAVE PATENT



PATENT

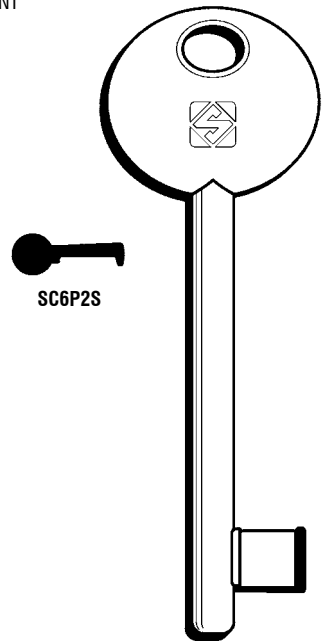

SC6P2S

Cod.	Conf.	Prezzo
SC6P2S	25	3,31 €

CHIAVE PATENT



PATENT

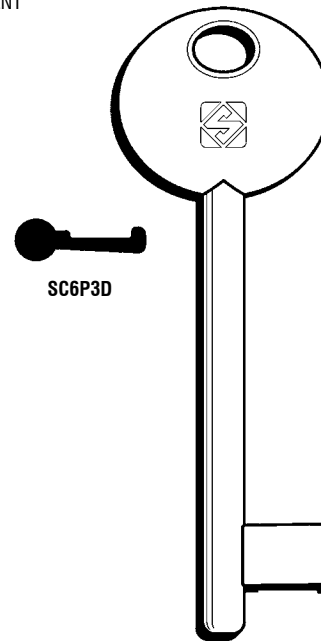

SC6P3D

Cod.	Conf.	Prezzo
SC6P3D	25	3,31 €

CHIAVE PATENT



PATENT

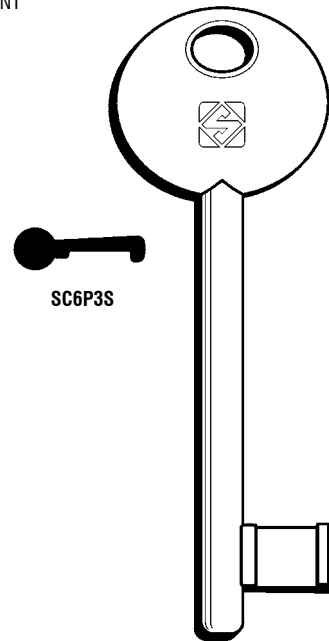

SC6P3S

Cod.	Conf.	Prezzo
SC6P3S	25	3,31 €

**CHIAVE PATENT NEMEF  
GHISA**  
PATENT

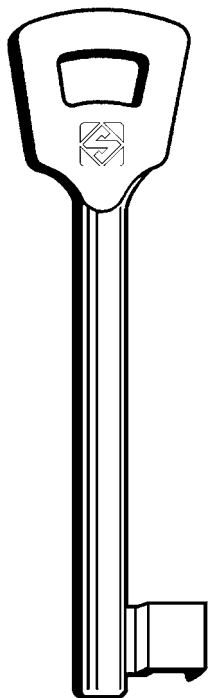

Cod.	Conf.	Prezzo
SC1NFHL	25	3,61 €
SC2NFHL	25	3,61 €
SC3NFHL	25	3,61 €
SC4NFHL	25	3,61 €
SC5NFHL	25	3,61 €
SC6NFHL	25	3,61 €
SC7NFHL	25	3,61 €
SC8NFHL	25	3,61 €
SC9NFHL	25	3,61 €
SC10NFHL	25	3,61 €

**CHIAVE BRONZATA  
PATENT**  
PATENT "Passepartout"

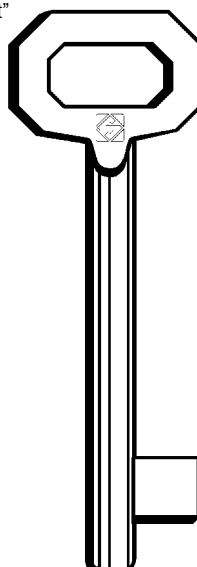
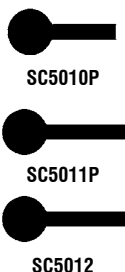

Cod.	Conf.	Prezzo
SC5010P	25	3,16 €
SC5011P	25	3,16 €
SC5012	25	3,16 €

**CHIAVE OTTONATA  
PATENT**  
PATENT "Passepartout"

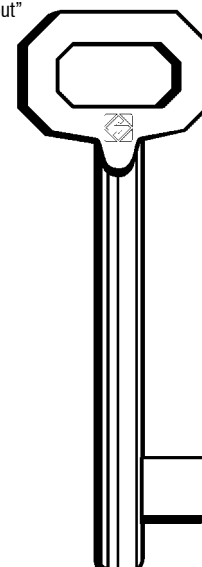

Cod.	Conf.	Prezzo
SC5010	25	3,16 €
SC5011	25	3,16 €

**CHIAVE A POMPA CR**



POMPA CR

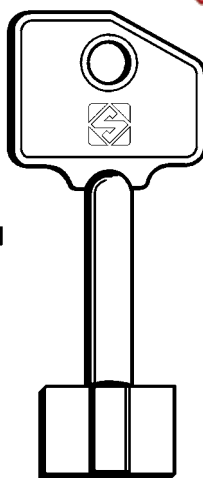

Cod.	Conf.	Prezzo
SC5R7	25	3,75 €

**CHIAVE A POMPA CR**



POMPA CR

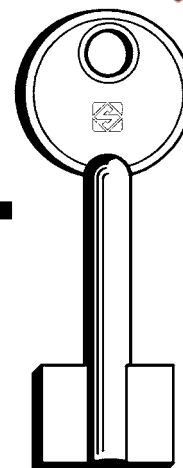

Cod.	Conf.	Prezzo
SCRCP	25	4,35 €

**CHIAVE A POMPA CR**



POMPA CR

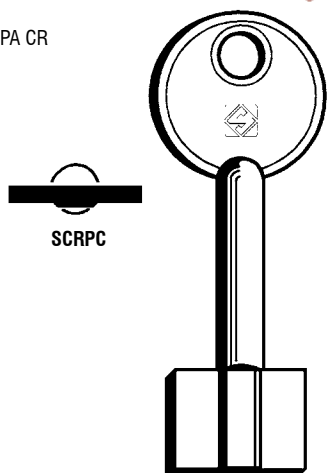

Cod.	Conf.	Prezzo
SCRPC	25	4,35 €

**CHIAVE A POMPA ISEO**



POMPA ISEO

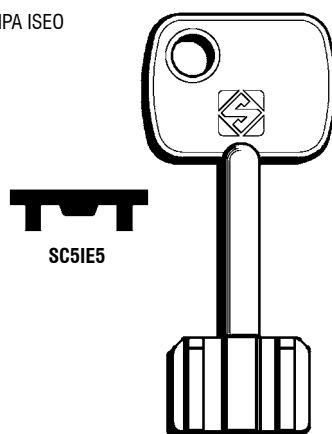

Cod.	Conf.	Prezzo
SC5IE5	25	5,08 €

**CHIAVE A POMPA MOTTURA**



POMPA MOTTURA

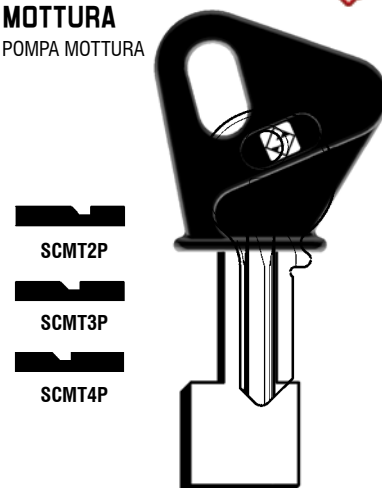

Cod.	Conf.	Prezzo
SCMT2P	25	3,75 €
SCMT3P	25	3,75 €
SCMT4P	25	3,75 €

**CHIAVE A POMPA POTENT**



POMPA POTENT

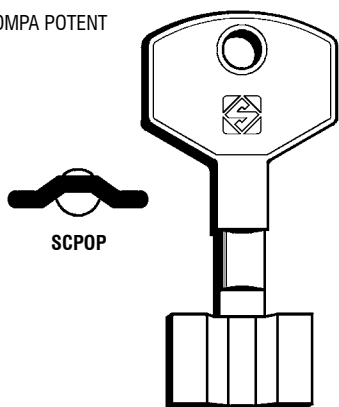

Cod.	Conf.	Prezzo
SCPOP	25	3,73 €

**CHIAVE A CROCE BURG WACHTER**



CROCE BURG WACHTER

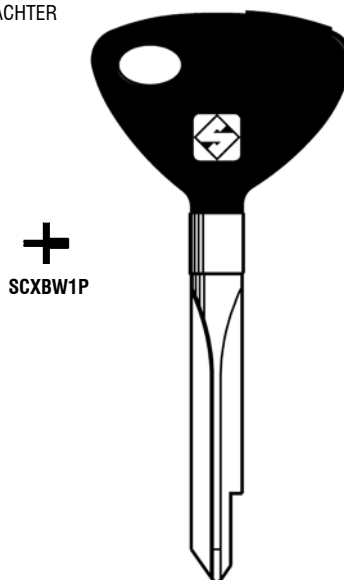

Cod.	Conf.	Prezzo
SCXBW1P	25	5,81 €

**CHIAVE A CROCE FIAM**



CROCE FIAM

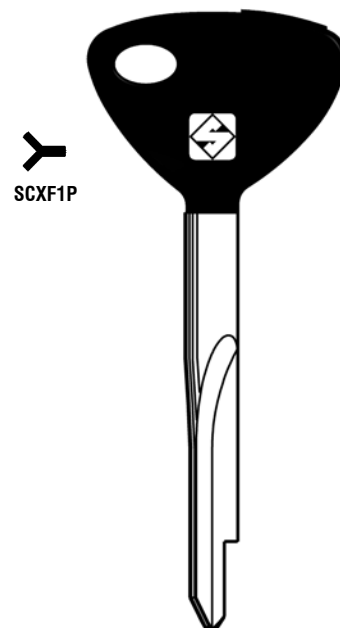

Cod.	Conf.	Prezzo
SCXF1P	25	5,81 €

**CHIAVE A CROCE FIAM**



CROCE FIAM

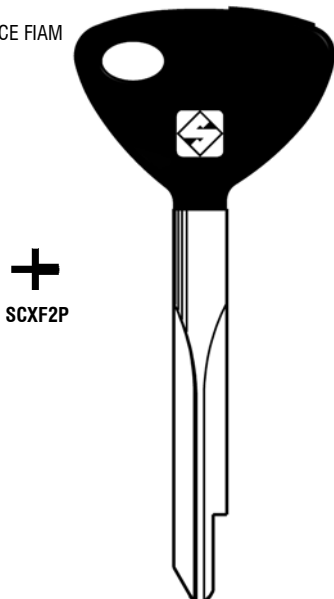

Cod.	Conf.	Prezzo
SCXF2P	25	5,81 €

**CHIAVE ACCIAIO PIAGGIO VESPA**

PIAGGIO VESPA

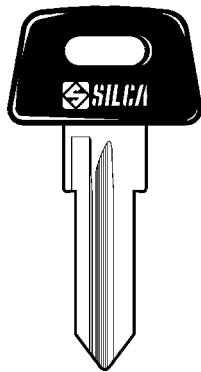

SCZD17RAP

Cod.	Conf.	Prezzo
SCZD17RAP	25	2,59 €

**CHIAVE MOTO TRANSPONDER BMW**

BMW -  
Senza chip,  
con tappo.

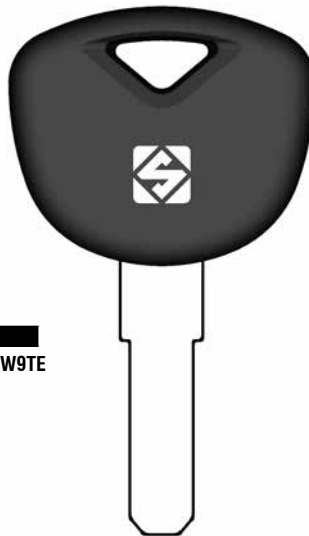

SCBW9TE

Cod.	Conf.	Prezzo
SCBW9TE	1	9,56 €

**CHIAVE MOTO TRANSPONDER HONDA/ KAWASAKY/TRIUMPH/ YAMAHA**

HONDA /  
KAWASAKY /  
TRIUMPH /  
YAMAHA -  
Senza chip,  
con tappo.

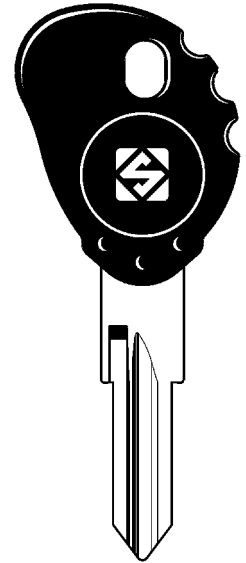

SCZD24RTE

Cod.	Conf.	Prezzo
SCZD24RTE	1	1,20 €

**CHIAVE MOTO TRANSPONDER YAMAHA**

YAMAHA -  
Senza chip,  
con tappo.

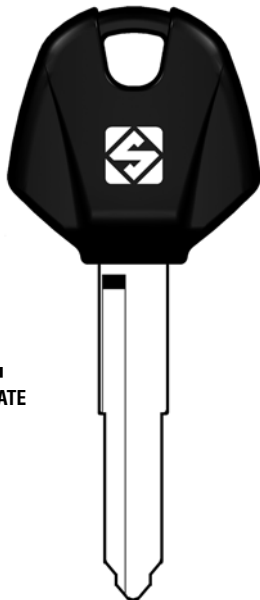

SCYH35RATE

Cod.	Conf.	Prezzo
SCYH35RATE	1	9,56 €

**CHIAVE ACCIAIO AUTO**



ZADI



SCZD24RDP

Cod.	Conf.	Prezzo
SCZD24RDP	25	2,59 €

**CHIAVE AUTO TRANSPONDER**

Senza chip,  
con tappo.

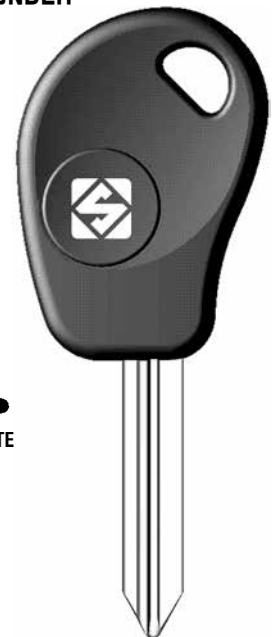

SCSX9TE

Cod.	Conf.	Prezzo
SCSX9TE	1	10,99 €

**CHIAVE AUTO FERRO**

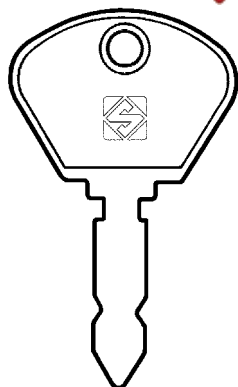

SCOM1

Cod.	Conf.	Prezzo
SCOM1	50	1,68 €

**CHIAVE AUTO  
TRANSPONDER ALFA  
ROMEO**

ALFA ROMEO -  
Senza  
chip,  
con  
tappo.

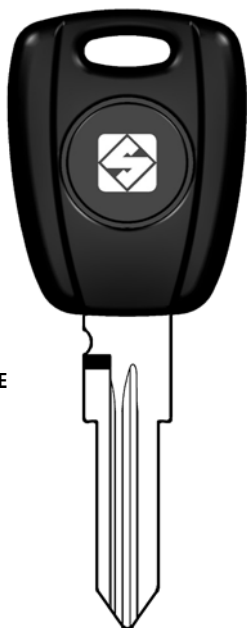

**SCGT15RTE**

Cod.	Conf.	Prezzo
<b>SCGT15RTE</b>	1	9,56 €

**CHIAVE AUTO  
TRANSPONDER AUDI/  
PORSCHE**

PORCHE / AUDI -  
Senza  
chip,  
con  
tappo.

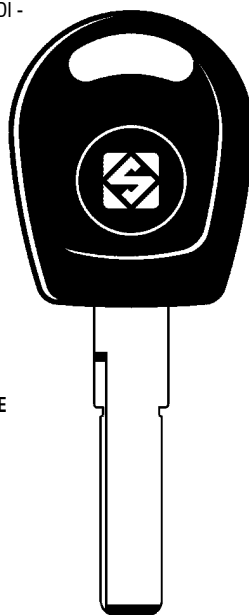

**SCHU66TE**

Cod.	Conf.	Prezzo
<b>SCHU66TE</b>	1	9,56 €

**CHIAVE AUTO  
TRANSPONDER BUICK/  
CADILLAC/CHEVROLET/  
GM/HOLDEN/OPEL**

BUICK / CADILLAC /  
CHEVROLET / GM /  
HOLDEN / OPEL -  
Senza  
chip,  
con  
tappo.



**SCHU100TE**

Cod.	Conf.	Prezzo
<b>SCHU100TE</b>	1	10,99 €

**CHIAVE AUTO  
TRANSPONDER  
CHEVROLET**

CHEVROLET -  
Senza  
chip,  
con  
tappo.

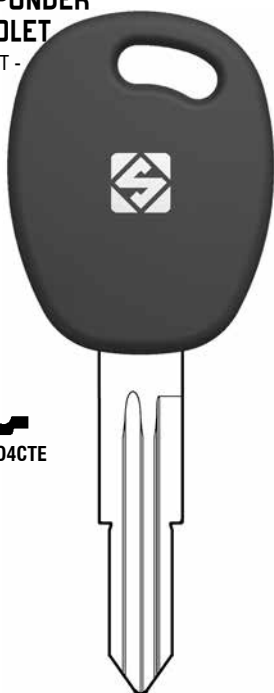

**SCDW04CTE**

Cod.	Conf.	Prezzo
<b>SCDW04CTE</b>	1	9,56 €

**CHIAVE AUTO  
TRANSPONDER FIAT/  
PEUGEOT/CITROEN**

FIAT / PEUGEOT /  
CITROEN -  
Senza  
chip,  
con  
tappo.

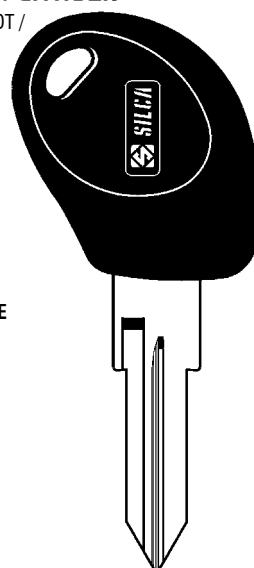

**SCGT10BTE**

Cod.	Conf.	Prezzo
<b>SCGT10BTE</b>	1	9,56 €

**CHIAVE AUTO FIAT**

FIAT

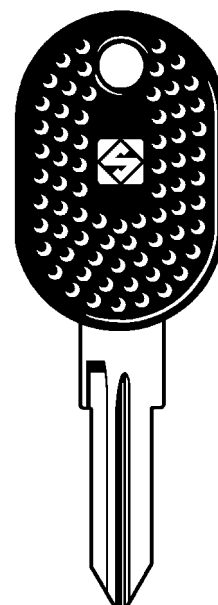

**SCGT10P**

Cod.	Conf.	Prezzo
<b>SCGT10P</b>	25	2,59 €



**CHIAVE AUTO  
TRANSPONDER FIAT**

FIAT -  
Senza  
chip,  
con  
tappo.

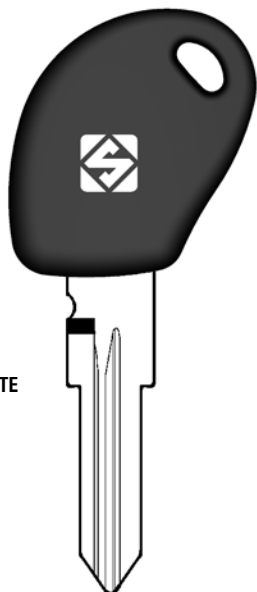

SCGT15RBTE

Cod.	Conf.	Prezzo
SCGT15RBTE	1	9,56 €

**CHIAVE AUTO  
TRANSPONDER FIAT/  
LANCIA/PEUGEOT/  
CITROEN**

FIAT / LANCIA /  
PEUGEOT /  
CITROEN -  
Senza  
chip,  
con  
tappo.

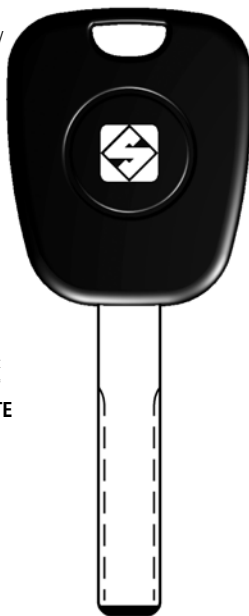

SCHU83TE

Cod.	Conf.	Prezzo
SCHU83TE	1	10,99 €

**CHIAVE AUTO  
TRANSPONDER FIAT/  
LANCIA/PEUGEOT/  
CITROEN**

FIAT / LANCIA /  
PEUGEOT /  
CITROEN -  
Senza  
chip,  
con  
tappo.



SCHU87RTE

Cod.	Conf.	Prezzo
SCHU87RTE	1	9,57 €

**CHIAVE AUTO  
TRANSPONDER FIAT/  
SUZUKI/NISSAN/OPEL**

FIAT / SUZUKI /  
NISSAN /  
OPEL -  
Senza  
chip,  
con  
tappo.

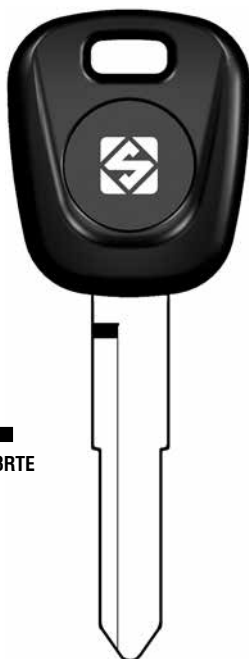

SCHU133RTE

Cod.	Conf.	Prezzo
SCHU133RTE	1	9,56 €

**CHIAVE AUTO  
TRANSPONDER FIAT/  
ALFA ROMEO/CITROEN/  
LANCIA/FORD/PEUGEOT**

FIAT  
ALFA ROMEO /  
CITROEN /  
LANCIA /  
FORD /  
PEUGEOT -  
Senza chip,  
con tappo.

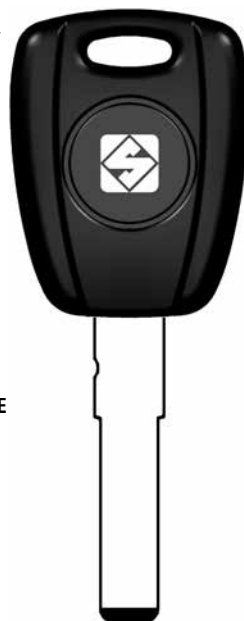

SCSIP22TE

Cod.	Conf.	Prezzo
SCSIP22TE	1	9,56 €

**CHIAVE AUTO  
TRANSPONDER FORD**

FORD -  
Senza  
chip,  
con  
tappo.

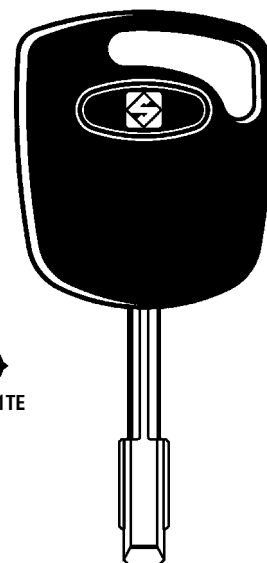

SCF021TE

Cod.	Conf.	Prezzo
SCF021TE	1	9,52 €

**CHIAVE AUTO  
TRANSPONDER FORD/  
LAND ROVER**



FORD /  
LAND ROVER -  
Senza  
chip,  
con  
tappo.

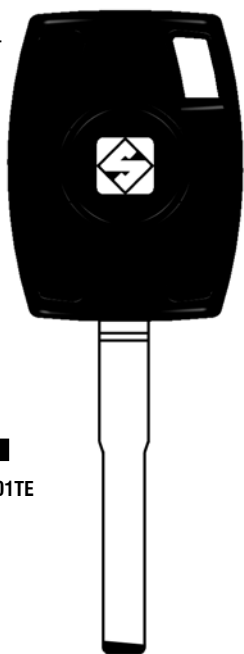

**SCHU101TE**

Cod.	Conf.	Prezzo
<b>SCHU101TE</b>	1	9,56 €

**CHIAVE MOTO  
TRANSPONDER HONDA/  
KAWASAKI**



HONDA  
KAWASAKI -  
Senza  
chip,  
con  
tappo.

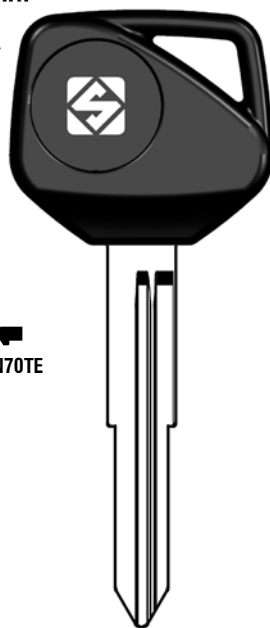

**SCHON70TE**

Cod.	Conf.	Prezzo
<b>SCHON70TE</b>	1	9,56 €

**CHIAVE AUTO  
TRANSPONDER HYUNDAI**



HYUNDAI -  
Senza  
chip,  
con  
tappo.

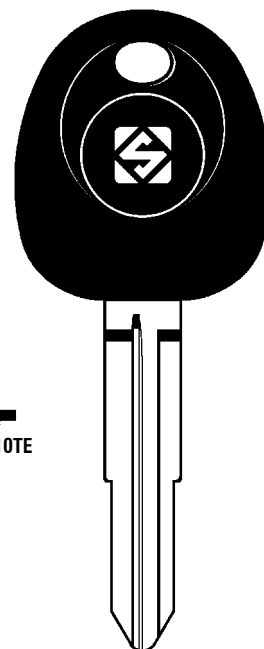

**SCHYN10TE**

Cod.	Conf.	Prezzo
<b>SCHYN10TE</b>	1	9,56 €

**CHIAVE AUTO  
TRANSPONDER  
HYUNDAI/KIA**



HYUNDAI / KIA -  
Senza  
chip,  
con  
tappo.

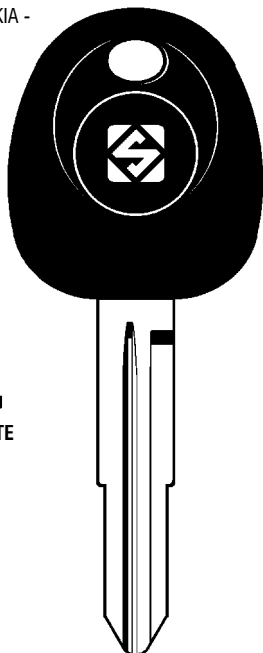

**SCHYN6TE**

Cod.	Conf.	Prezzo
<b>SCHYN6TE</b>	1	9,56 €

**CHIAVE AUTO  
TRANSPONDER  
MITSUBISHI**



MITSUBISHI -  
Senza  
chip,  
con  
tappo.

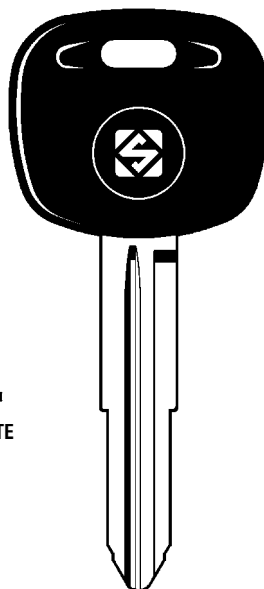

**SCMIT8TE**

Cod.	Conf.	Prezzo
<b>SCMIT8TE</b>	1	9,56 €

**CHIAVE AUTO  
TRANSPONDER NISSAN/  
OPEL/RENAULT**



NISSAN / OPEL /  
RENAULT -  
Senza  
chip,  
con  
tappo.

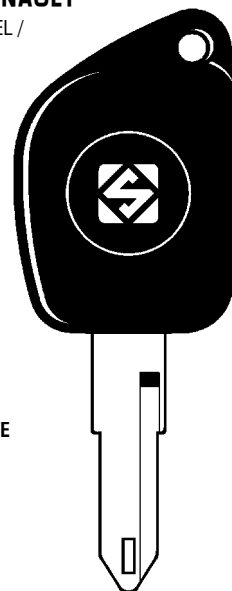

**SCNE72ATE**

Cod.	Conf.	Prezzo
<b>SCNE72ATE</b>	1	9,56 €

**CHIAVE AUTO  
TRANSPONDER NISSAN/  
PEUGEOT/RENAULT**



NISSAN / PEUGEOT /  
RENAULT -  
Senza  
chip,  
con  
tappo.

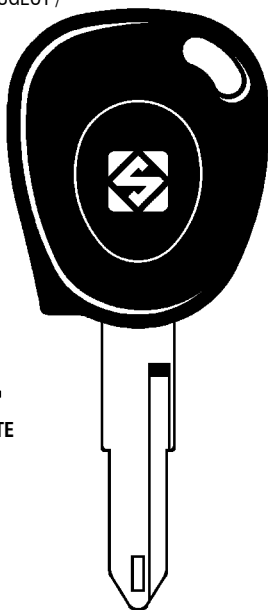

 SCNE73TE

Cod.	Conf.	Prezzo
SCNE73TE	1	9,56 €

**CHIAVE AUTO  
TRANSPONDER NISSAN**



NISSAN -  
Senza  
chip,  
con  
tappo.

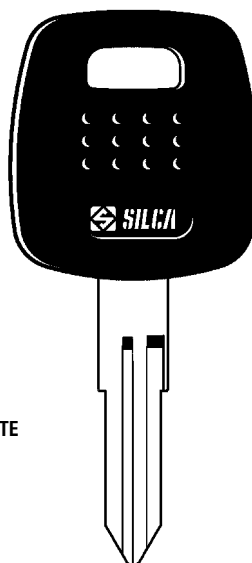

 SCNSN11TE

Cod.	Conf.	Prezzo
SCNSN11TE	1	9,56 €

**CHIAVE AUTO  
TRANSPONDER NISSAN/  
SUBARU/SUZUKI/  
INFINITI**



NISSAN /  
SUBARU /  
SUZUKI /  
INFINITI -  
Senza  
chip,  
con  
tappo.

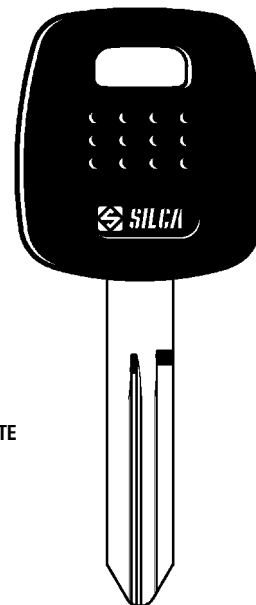

 SCNSN14TE

Cod.	Conf.	Prezzo
SCNSN14TE	1	9,56 €

**CHIAVE AUTO  
TRANSPONDER RENAULT**



RENAULT -  
Senza  
chip,  
con  
tappo.

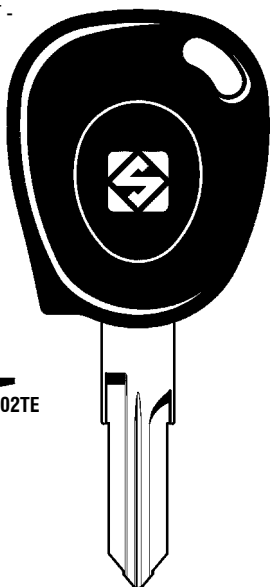

 SCVAC102TE

Cod.	Conf.	Prezzo
SCVAC102TE	1	9,56 €

**CHIAVE AUTO  
TRANSPONDER SMART**



SMART -  
Senza  
chip,  
con  
tappo.



 SCVA2TE

Cod.	Conf.	Prezzo
SCVA2TE	1	9,56 €

**CHIAVE AUTO  
TRANSPONDER SUZUKI**



SUZUKI -  
Senza chip,  
con gusci.

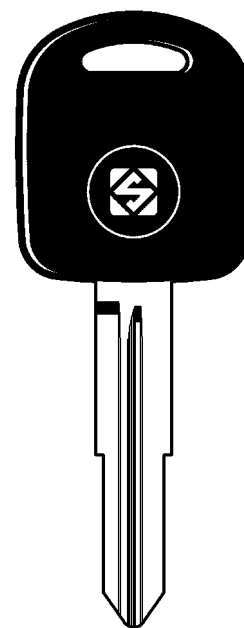

 SCSZ11RTE

Cod.	Conf.	Prezzo
SCSZ11RTE	1	9,56 €

**CHIAVE AUTO  
TRANSPONDER SUZUKI**



SUZUKI -  
Senza  
chip,  
con  
tappo.

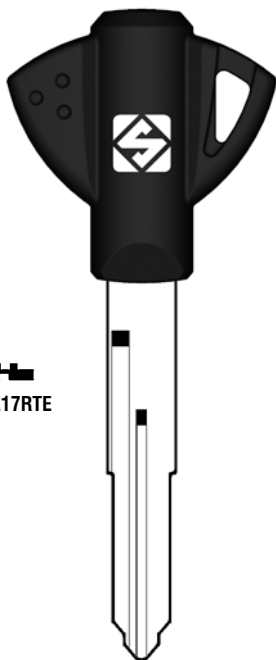

  
SCSZ17RTE

Cod.	Conf.	Prezzo
SCSZ17RTE	1	9,56 €

**CHIAVE AUTO  
TRANSPONDER TOYOTA/  
DAIHATSU**



TOYOTA /  
DAIHATSU -  
Senza  
chip,  
con  
tappo.

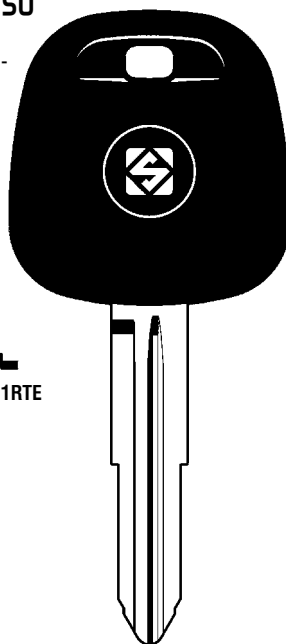

  
SCTOY41RTE

Cod.	Conf.	Prezzo
SCTOY41RTE	1	9,56 €

**CHIAVE AUTO  
TRANSPONDER TOYOTA**



TOYOTA -  
Senza  
chip,  
con  
tappo.

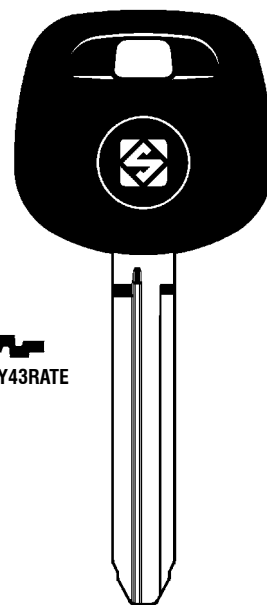

  
SCTOY43RATE

Cod.	Conf.	Prezzo
SCTOY43RATE	1	9,56 €

**CHIAVE AUTO  
TRANSPONDER TOYOTA/  
DAIHATSU**



TOYOTA /  
DAIHATSU -  
Senza  
chip,  
con  
tappo.

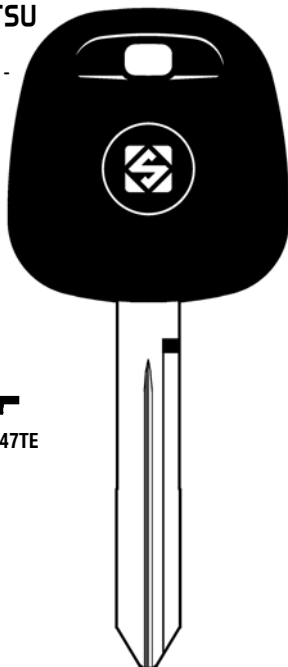

  
SCTOY47TE

Cod.	Conf.	Prezzo
SCTOY47TE	1	9,56 €

**CHIAVE AUTO  
TRANSPONDER TOYOTA**



TOYOTA -  
Senza  
chip,  
con  
tappo.

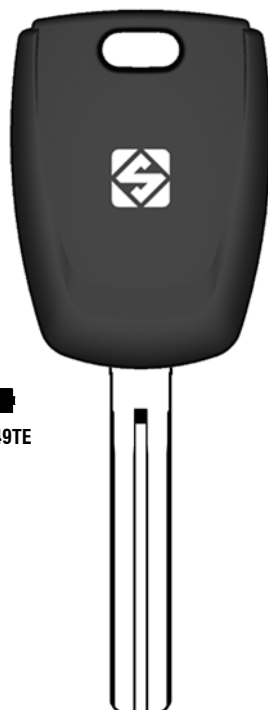

  
SCTOY49TE

Cod.	Conf.	Prezzo
SCTOY49TE	1	9,56 €

**CHIAVE AUTO  
TRANSPONDER TOYOTA**



TOYOTA -  
Senza chip,  
con gusci.

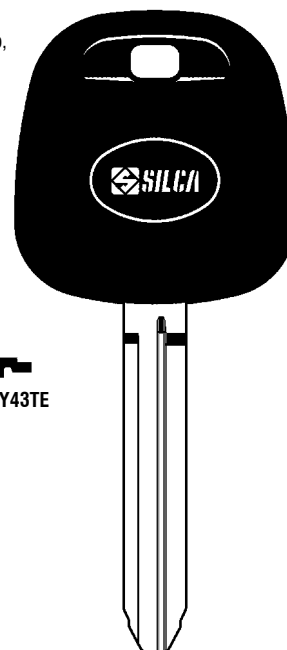

  
SCTOY43TE

Cod.	Conf.	Prezzo
SCTOY43TE	1	9,56 €

## KEY SHELL AUDI



Bottoni apri/chiedi e bagagliaio, batteria integrata nel guscio, compatibilità "Silca TE".



Cod.	Descrizione	Conf.	Prezzo
SCHURS2	2 bottoni	1	9,49 €

## KEY SHELL AUDI



Bottoni apri/chiedi, batteria integrata nel guscio, compatibilità "Silca TE".



Cod.	Descrizione	Conf.	Prezzo
SCHURSC2	2 bottoni	1	9,49 €

## KEY SHELL AUDI



Bottone apri/chiedi e bagagliaio, batteria integrata nel guscio, compatibilità "Silca TE".



Cod.	Descrizione	Conf.	Prezzo
SCHURSC8	3 bottoni	1	9,49 €

## KEY SHELL OTTONE BMW



Bottone apri/chiedi e bagagliaio, batteria integrata nel circuito.



Cod.	Descrizione	Conf.	Prezzo
SCHU131RRS8	3 bottoni	1	16,79 €

## KEY SHELL OTTONE BMW



Bottone apri/chiedi e bagagliaio.



Cod.	Descrizione	Conf.	Prezzo
SCHU178RS8	3 bottoni	1	31,13 €

## SOLO TESTA KEY SHELL OTTONE FORD



Bottoni apri/chiedi e bagagliaio, batteria integrata nel guscio, compatibilità "Silca TE".



Cod.	Descrizione	Conf.	Prezzo
SCFORS8	3 bottoni	1	9,49 €

## SOLO TESTA KEY SHELL OTTONE FORD



Bottoni apri/chiedi e bagagliaio, batteria integrata nel guscio, compatibilità "Silca TE".



Cod.	Descrizione	Conf.	Prezzo
SCFORS8	3 bottoni	1	10,41 €

## KEY SHELL OTTONE FORD



Bottone apri/chiedi e bagagliaio, con porta transponder.



Cod.	Descrizione	Conf.	Prezzo
SCHU198CRS8	3 bottoni	1	22,52 €

## KEY SHELL OTTONE MERCEDES



Bottone apri/chiedi e bagagliaio, batteria integrata nel circuito, senza porta transponder.



Cod.	Descrizione	Conf.	Prezzo
SCHURS5	3 bottoni	1	30,71 €

## KEY SHELL OTTONE MINI



Bottone apri/chiedi e bagagliaio, batteria integrata nel circuito.



Cod.	Descrizione	Conf.	Prezzo
SCHU200ARS8	3 bottoni	1	22,52 €

### KEY SHELL OPEL - VAUXHALL



Bottoni apri/chiodi, batteria integrata nel circuito.



Cod.	Descrizione	Conf.	Prezzo
SCHURSG2N	2 bottoni	1	10,41 €

### KEY SHELL OPEL - VAUXHALL



Bottoni apri/chiodi e bagagliaio, batteria integrata nel circuito, compatibilità "Silca TE".



Cod.	Descrizione	Conf.	Prezzo
SCHURSG8N	3 bottoni	1	10,41 €

### KEY SHELL OPEL - VAUXHALL



Bottoni apri/chiodi, batteria integrata nel circuito, compatibilità "Silca TE".



Cod.	Descrizione	Conf.	Prezzo
SCHURSH2N	2 bottoni	1	9,49 €

### KEY SHELL OTTONE OPEL - VAUXHALL



Bottoni apri/chiodi, batteria integrata nel guscio, compatibilità "Silca TE".



Cod.	Descrizione	Conf.	Prezzo
SCVACRS2	2 bottoni	1	9,49 €

### KEY SHELL OTTONE OPEL - VAUXHALL



Bottoni apri/chiodi, batteria integrata nel guscio, compatibilità "Silca TE".



Cod.	Descrizione	Conf.	Prezzo
SCVACRSA2	2 bottoni	1	9,49 €

### KEY SHELL ALPACCA RENAULT



Bottoni apri/chiodi e bagagliaio, batteria integrata nel guscio.



Cod.	Descrizione	Conf.	Prezzo
SCVA150RS8	3 bottoni	1	20,07 €

### KEY SHELL RENAULT



Bottoni apri/chiodi, batteria integrata nel circuito, compatibilità "Silca TE".



Cod.	Descrizione	Conf.	Prezzo
SCNERSD1N	1 bottone	1	10,41 €

### KEY SHELL RENAULT



Bottoni apri/chiodi e bagagliaio, batteria integrata nel guscio, senza porta transponder, compatibilità "Silca TE".



Cod.	Descrizione	Conf.	Prezzo
SCNERS5	3 bottoni	1	10,41 €

### KEY SHELL SEAT



Bottoni apri/chiodi e bagagliaio, batteria integrata nel guscio, compatibilità "Silca TE".



Cod.	Descrizione	Conf.	Prezzo
SCHURSA8	3 bottoni	1	9,49 €

### KEY SHELL SEAT



Bottoni apri/chiodi, batteria integrata nel guscio, compatibilità "Silca TE".



Cod.	Descrizione	Conf.	Prezzo
SCHURSA2	2 bottoni	1	9,49 €

### KEY SHELL OTTONE TOYOTA

Bottone apri/chiudi, batteria integrata nel guscio.



Cod.	Descrizione	Conf.	Prezzo
SCTOYRSE2	2 bottoni	1	25,59 €

### KEY SHELL OLC BMW

Bottone apri/chiudi, batteria integrata nel circuito.



Cod.	Descrizione	Conf.	Prezzo
SCHU92RRS2N	2 bottoni	1	12,28 €

### KEY SHELL VOLKSWAGEN

Bottone apri/chiudi e bagagliaio, batteria integrata nel guscio, compatibilità "Silca TE".



Cod.	Descrizione	Conf.	Prezzo
SCHURSB8	3 bottoni	1	9,49 €

### KEY SHELL OLC BMW

Bottone apri/chiudi e bagagliaio, batteria integrata nel circuito.



Cod.	Descrizione	Conf.	Prezzo
SCHU92RRS8N	3 bottoni	1	12,28 €

### KEY SHELL OTTONE ALFA ROMEO

Bottone apri/chiudi e bagagliaio, batteria integrata nel guscio, compatibilità "Silca TE".



Cod.	Descrizione	Conf.	Prezzo
SCSIP22BRS8	3 bottoni	1	20,07 €

### KEY SHELL ALPACCA CITROEN

Bottone apri/chiudi, batteria integrata nel guscio, compatibilità "Silca TE".



Cod.	Descrizione	Conf.	Prezzo
SCHU83RS2	2 bottoni	1	10,41 €

### KEY SHELL OTTONE AUDI

Bottone apri/chiudi e bagagliaio, batteria integrata nel guscio, compatibilità "Silca TE".



Cod.	Descrizione	Conf.	Prezzo
SCHU66ARS8	3 bottoni	1	20,07 €

### KEY SHELL OLC CITROEN

Bottone apri/chiudi, batteria integrata nel circuito, compatibilità "Silca TE".



Cod.	Descrizione	Conf.	Prezzo
SCHU83ARS2N	2 bottoni	1	20,07 €

### KEY SHELL DLC CITROEN

Bottone apri/chiedi e porte scorrevoli, batteria integrata nel circuito, compatibilità "Silca TE".



SCHU83CRS7N

Cod.	Descrizione	Conf.	Prezzo
SCHU83CRS7N	4 bottoni	1	20,07 €

### KEY SHELL OTTONE CITROEN

Bottone apri/chiedi e porte scorrevoli, batteria integrata nel guscio, compatibilità "Silca TE".



SCHU83CRS7

Cod.	Descrizione	Conf.	Prezzo
SCHU83CRS7	4 bottoni	1	20,07 €

### KEY SHELL DLC CITROEN

Bottone apri/chiedi e bagagliaio, batteria integrata nel circuito, compatibilità "Silca TE".



SCHU83BRS8N

Cod.	Descrizione	Conf.	Prezzo
SCHU83BRS8N	3 bottoni	1	20,07 €

### KEY SHELL OTTONE CITROEN

Bottone apri/chiedi, batteria integrata nel circuito, compatibilità "Silca TE".



SCHU83BRS8

Cod.	Descrizione	Conf.	Prezzo
SCHU83BRS8	3 bottoni	1	20,07 €

### KEY SHELL OTTONE CITROEN

Bottone apri/chiedi, batteria integrata nel guscio, compatibilità "Silca TE".



SCVA2BRS2

Cod.	Descrizione	Conf.	Prezzo
SCVA2BRS2	2 bottoni	1	20,07 €

### KEY SHELL OTTONE CITROEN

Bottone apri/chiedi, batteria integrata nel guscio, compatibilità "Silca TE".



SCSX9ARS2

Cod.	Descrizione	Conf.	Prezzo
SCSX9ARS2	2 bottoni	1	9,49 €



**KEY SHELL OTTONE CHRYSLER**

Bottone apri/chiedi, batteria integrata nel guscio, compatibilità "Silca TE".



SCCY24RS2

Cod.	Descrizione	Conf.	Prezzo
SCCY24RS2	2 bottoni	1	10,41 €

**KEY SHELL OTTONE FIAT**

Bottone apri/chiedi, batteria integrata nel guscio.



SCGT15RRS1

Cod.	Descrizione	Conf.	Prezzo
SCGT15RRS1	1 bottone	1	13,61 €

**KEY SHELL OTTONE CHRYSLER**

Bottone apri/chiedi e bagagliaio, batteria integrata nel guscio, compatibilità "Silca TE".



SCCY24RS8

Cod.	Descrizione	Conf.	Prezzo
SCCY24RS8	3 bottoni	1	10,41 €

**KEY SHELL OTTONE FIAT**

Bottone apri/chiedi e bagagliaio, batteria integrata nel guscio, compatibilità "Silca TE".



SCSIP22JRS7

Cod.	Descrizione	Conf.	Prezzo
SCSIP22JRS7	4 bottoni	1	33,86 €

**KEY SHELL OTTONE FIAT**

Bottone apri/chiedi, batteria integrata nel guscio, compatibilità "Silca TE".



SCGT15RARS1

Cod.	Descrizione	Conf.	Prezzo
SCGT15RARS1	1 bottone	1	10,41 €

**KEY SHELL OTTONE ABARTH**

Bottone apri/chiedi e bagagliaio, batteria integrata nel guscio, compatibilità "Silca TE".



SCSIP22CRS8

Cod.	Descrizione	Conf.	Prezzo
SCSIP22CRS8	3 bottoni	1	20,07 €

**KEY SHELL OTTONE FIAT**

Bottone apri/chiedi, batteria integrata nel guscio, compatibilità "Silca TE".



SCSIP22ARS1

Cod.	Descrizione	Conf.	Prezzo
SCSIP22ARS1	1 bottone	1	10,41 €

**KEY SHELL OTTONE IVECO**

Bottone apri/chiedi, compatibilità "Silca TE".



SCGT10RS1

Cod.	Descrizione	Conf.	Prezzo
SCGT10RS1	1 bottone	1	13,03 €

### KEY SHELL OTTONE FORD

Bottone apri/chiudi e bagagliaio, batteria integrata nel guscio, compatibilità "Silca TE".



SCHU101BRS8



Cod.	Descrizione	Conf.	Prezzo
SCHU101BRS8	3 bottoni	1	22,52 €

### KEY SHELL OTTONE HONDA

Bottone apri/chiudi e bagagliaio, batteria integrata nel circuito, senza porta transponder, compatibilità "Silca TE".



SCHON66RS5



Cod.	Descrizione	Conf.	Prezzo
SCHON66RS5	3 bottoni	1	10,41 €

### KEY SHELL OTTONE FORD

Bottone apri/chiudi e bagagliaio, batteria integrata nel guscio, compatibilità "Silca TE".



SCSIP22ERS8



Cod.	Descrizione	Conf.	Prezzo
SCSIP22ERS8	3 bottoni	1	23,89 €

### KEY SHELL OTTONE HONDA

Bottone apri/chiudi e bagagliaio, batteria integrata nel circuito, con porta transponder, compatibilità "Silca TE".



SCHON66RS6



Cod.	Descrizione	Conf.	Prezzo
SCHON66RS6	3 bottoni	1	10,41 €

### KEY SHELL OTTONE HONDA

Bottone apri/chiudi, batteria integrata nel circuito, senza porta transponder, compatibilità "Silca TE".



SCHON66RS3



Cod.	Descrizione	Conf.	Prezzo
SCHON66RS3	2 bottoni	1	10,41 €

### KEY SHELL OTTONE HYUNDAI

Bottone apri/chiudi e bagagliaio, compatibilità "Silca TE".



SCKIA8RS8



Cod.	Descrizione	Conf.	Prezzo
SCKIA8RS8	3 bottoni	1	20,07 €

### KEY SHELL OTTONE JEEP

Bottone apri/chiedi e bagagliaio, batteria integrata nel guscio, compatibilità "Silca TE".



SCSIP22JRS8



Cod.	Descrizione	Conf.	Prezzo
SCSIP22JRS8	3 bottoni	1	33,86 €

### KEY SHELL OTTONE NISSAN

Bottone apri/chiedi e bagagliaio, batteria integrata nel guscio, compatibilità "Silca TE".



SCNSN14RS8

Cod.	Descrizione	Conf.	Prezzo
SCNSN14RS8	3 bottoni	1	10,41 €

### KEY SHELL ALPACCA MINI

Bottone apri/chiedi, batteria integrata nel guscio, con porta transponder.



Cod.	Descrizione	Conf.	Prezzo
SCHU200RS2	2 bottoni	1	20,07 €

### KEY SHELL OTTONE NISSAN

Bottone apri/chiedi, batteria integrata nel guscio, compatibilità "Silca TE".



SCNSN14DRS2

Cod.	Descrizione	Conf.	Prezzo
SCNSN14DRS2	2 bottoni	1	11,33 €

### KEY SHELL OTTONE MITSUBISHI

Bottone apri/chiedi e bagagliaio, con bottone rosso antipanico, compatibilità "Silca TE".



SCMIT8RS2

Cod.	Descrizione	Conf.	Prezzo
SCMIT8RS2	2 bottoni	1	10,41 €

### KEY SHELL OTTONE NISSAN

Bottone apri/chiedi, batteria integrata nel guscio, compatibilità "Silca TE".



SCNSN14RS2

Cod.	Descrizione	Conf.	Prezzo
SCNSN14RS2	2 bottoni	1	10,41 €

**KEY SHELL OTTONE  
OPEL - VAUXHALL**

Bottone apri/chiudi, batteria integrata nel guscio, compatibilità "Silca TE".



SCHU100RS2

Cod.	Descrizione	Conf.	Prezzo
SCHU100RS2	2 bottoni	1	20,07 €

**KEY SHELL ALPACCA PEUGEOT**

Bottone apri/chiudi, batteria integrata nel circuito, compatibilità "Silca TE".



SCHU83ARS2

Cod.	Descrizione	Conf.	Prezzo
SCHU83ARS2	2 bottoni	1	20,07 €

**KEY SHELL OTTONE OPEL - VAUXHALL**

Bottone apri/chiudi e bagagliaio, batteria integrata nel circuito, compatibilità "Silca TE".



SCHU100RS8

Cod.	Descrizione	Conf.	Prezzo
SCHU100RS8	3 bottoni	1	20,07 €

**KEY SHELL OLC PEUGEOT**

Bottone apri/chiudi e bagagliaio, batteria integrata nel circuito, compatibilità "Silca TE".



SCNE78BRS8N

Cod.	Descrizione	Conf.	Prezzo
SCNE78BRS8N	3 bottoni	1	20,07 €

**KEY SHELL OTTONE  
OPEL - VAUXHALL**

Bottone apri/chiudi, batteria integrata nel circuito, compatibilità "Silca TE".



SCHU87RS2

Cod.	Descrizione	Conf.	Prezzo
SCHU87RS2	2 bottoni	1	11,46 €

**KEY SHELL OLC PEUGEOT**

Bottone apri/chiudi, batteria integrata nel circuito, compatibilità "Silca TE".



SCVA2ARS2N

Cod.	Descrizione	Conf.	Prezzo
SCVA2ARS2N	2 bottoni	1	20,07 €

**KEY SHELL OLC PEUGEOT**

Bottone apri/chiudi e bagagliaio, batteria integrata nel circuito, compatibilità "Silca TE".



SCVA2BRS8N

Cod.	Descrizione	Conf.	Prezzo
SCVA2BRS8N	3 bottoni	1	20,07 €

**KEY SHELL OLC PEUGEOT**

Bottone apri/chiedi e per porte scorrevoli, batteria integrata nel circuito, compatibilità "Silca TE".



SCVA2CRS7N

Cod.	Descrizione	Conf.	Prezzo
SCVA2CRS7N	4 bottoni	1	20,07 €

**KEY SHELL PEUGEOT**

Bottone apri/chiedi, batteria integrata nel circuito, compatibilità "Silca TE".



SCNE78ARS2N

Cod.	Descrizione	Conf.	Prezzo
SCNE78ARS2N	2 bottoni	1	20,07 €

**KEY SHELL OLC PEUGEOT**

Bottone apri/chiedi, batteria integrata nel circuito, compatibilità "Silca TE".



SCNE78RS2N

Cod.	Descrizione	Conf.	Prezzo
SCNE78RS2N	2 bottoni	1	11,46 €

**KEY SHELL OTTONE PEUGEOT**

Bottone apri/chiedi e bagagliaio, batteria integrata nel guscio, compatibilità "Silca TE".



SCNE78BRS8

Cod.	Descrizione	Conf.	Prezzo
SCNE78BRS8	3 bottoni	1	20,07 €

**KEY SHELL OTTONE PEUGEOT**

Bottone apri/chiedi e bagagliaio, batteria integrata nel guscio, compatibilità "Silca TE".



SCVA2BRS8

Cod.	Descrizione	Conf.	Prezzo
SCVA2BRS8	3 bottoni	1	20,07 €

**KEY SHELL OTTONE PEUGEOT**

Bottone apri/chiedi e porte scorrevoli, batteria integrata nel guscio, compatibilità "Silca TE".



SCVA2CRS7

Cod.	Descrizione	Conf.	Prezzo
SCVA2CRS7	4 bottoni	1	20,07 €

**KEY SHELL OTTONE PEUGEOT**

Bottone apri/chiedi, batteria integrata nel guscio, compatibilità "Silca TE".



SCNE73RS2

Cod.	Descrizione	Conf.	Prezzo
SCNE73RS2	2 bottoni	1	11,46 €

### KEY SHELL OTTONE PEUGEOT

Bottone apri/chiedi, batteria integrata nel guscio, compatibilità "Silca TE".



SCSX9RS2

Cod.	Descrizione	Conf.	Prezzo
SCSX9RS2	2 bottoni	1	13,03 €

### KEY SHELL OTTONE RENAULT

Bottone apri/chiedi, batteria integrata nel guscio.



SCNE73BRS1

Cod.	Descrizione	Conf.	Prezzo
SCNE73BRS1	1 bottone	1	10,41 €

### KEY SHELL OLC RENAULT

Bottone apri/chiedi, batteria integrata nel guscio, compatibilità "Silca TE".



SCVAC102B1N

Cod.	Descrizione	Conf.	Prezzo
SCVAC102B1N	1 bottone	1	10,41 €

### KEY SHELL OTTONE RENAULT

Bottone apri/chiedi e bagagliaio, batteria integrata nel guscio, compatibilità "Silca TE".



SCVA2ERS8

Cod.	Descrizione	Conf.	Prezzo
SCVA2ERS8	3 bottoni	1	20,07 €

### KEY SHELL OTTONE RENAULT

Bottone apri/chiedi, batteria integrata nel guscio, compatibilità "Silca TE".



SCVA2ERS2

Cod.	Descrizione	Conf.	Prezzo
SCVA2ERS2	2 bottoni	1	20,07 €

### KEY SHELL OTTONE RENAULT

Bottone apri/chiedi, batteria integrata nel guscio, compatibilità "Silca TE".



SCVAC102ARS1

SCNE73ARS1

Cod.	Descrizione	Conf.	Prezzo
SCVAC102ARS1	1 bottone	1	10,41 €
SCNE73ARS1	1 bottone	1	10,41 €

### KEY SHELL OTTONE SMART

Bottone apri/chiedi, batteria integrata nel circuito.



Cod.	Descrizione	Conf.	Prezzo
SCYM23RS1	1 bottone	1	13,61 €

### KEY SHELL OTTONE SMART

Bottone apri/chiedi e bagagliaio, batteria integrata nel guscio, compatibilità "Silca TE".



SCVA2DRS8

Cod.	Descrizione	Conf.	Prezzo
SCVA2DRS8	3 bottoni	1	13,61 €

### KEY SHELL OTTONE SUBARU

Bottone apri/chiedi e bagagliaio, batteria integrata nel guscio, compatibilità "Silca TE".



SCDAT17BRS8

SCNSN19BRS8

Cod.	Descrizione	Conf.	Prezzo
SCDAT17BRS8	3 bottoni	1	9,97 €
SCNSN19BRS8	3 bottoni	1	9,97 €

### KEY SHELL OTTONE SMART

Bottone apri/chiedi e bagagliaio, batteria integrata nel circuito.



Cod.	Descrizione	Conf.	Prezzo
SCYM23RS8	3 bottoni	1	13,61 €

### KEY SHELL OTTONE SUZUKI

Bottone apri/chiedi, batteria integrata nel circuito, compatibilità "Silca TE".



CSZ11RRS2

Cod.	Descrizione	Conf.	Prezzo
SCSZ11RRS2	2 bottoni	1	13,61 €

### KEY SHELL OTTONE SEAT

Bottone apri/chiedi e bagagliaio, batteria integrata nel guscio, compatibilità "Silca TE".



SCHU66BRS8

Cod.	Descrizione	Conf.	Prezzo
SCHU66BRS8	3 bottoni	1	20,07 €

### KEY SHELL OTTONE TOYOTA

Bottone apri/chiedi e bagagliaio, batteria integrata nel circuito, compatibilità "Silca TE".



SCTOY43ARS8

Cod.	Descrizione	Conf.	Prezzo
SCTOY43ARS8	3 bottoni	1	13,03 €

**KEY SHELL OTTONE TOYOTA**

Bottone apri/chiudi, batteria integrata nel circuito, compatibilità "Silca TE".



Cod.	Descrizione	Conf.	Prezzo
SCTOY43ARS2	2 bottoni	1	13,03 €

**KEY SHELL OTTONE TOYOTA**

Bottone apri/chiudi e bagagliaio, batteria integrata nel circuito, compatibilità "Silca TE".



Cod.	Descrizione	Conf.	Prezzo
SCTOY41RBR8	3 bottoni	1	10,41 €
SCTOY47BR8	3 bottoni	1	10,41 €
SCTOY43BR8	3 bottoni	1	10,41 €
SCTOY48BR8	3 bottoni	1	10,41 €

**KEY SHELL OTTONE TOYOTA**

Bottone apri/chiudi, batteria integrata nel guscio.



Cod.	Descrizione	Conf.	Prezzo
SCVA2RS2	2 bottoni	1	10,41 €

**CANNA FLIP OTTONE KEY SHELL FORD**

Chiave a scatto, compatibilità "Silca TE".



Cod.	Descrizione	Conf.	Prezzo
SCHU101ARS8	3 bottoni	1	10,41 €

**CANNA FLIP OTTONE KEY SHELL VOLKSWAGEN**

Chiave a scatto, compatibilità "Silca TE".



Cod.	Descrizione	Conf.	Prezzo
SCHU66PRS	2 bottoni	1	9,49 €

**KEY SHELL OTTONE TOYOTA**

Bottone apri/chiudi, batteria integrata nel circuito, compatibilità "Silca TE".



Cod.	Descrizione	Conf.	Prezzo
SCTOY41RRS2	2 bottoni	1	10,41 €
SCTOY47BR8	2 bottoni	1	10,41 €

**CANNA FLIP OTTONE KEY SHELL VOLKSWAGEN**

Chiave a scatto, compatibilità "Silca TE".



Cod.	Descrizione	Conf.	Prezzo
SCHU66APRS	3 bottoni	1	9,49 €



### KEY SHELL OTTONE RUBBER PAD MINI



Bottone apri/chiudi.



Cod.	Descrizione	Conf.	Prezzo
SCYMRS1	1 bottone	1	1,82 €

### KEY SHELL OTTONE RUBBER PAD SMART



Bottone apri/chiudi e bagagliaio.



Cod.	Descrizione	Conf.	Prezzo
SCYMRS8	3 bottoni	1	1,82 €

### KEY SHELL OTTONE RUBBER PAD TOYOTA



Bottone apri/chiudi e bagagliaio.



Cod.	Descrizione	Conf.	Prezzo
SCTOYRS8	3 bottoni	1	1,82 €

### KEY SHELL OTTONE RUBBER PAD ABARTH



Bottone apri/chiudi e bagagliaio.



Cod.	Descrizione	Conf.	Prezzo
SCSIPRS8	3 bottoni	1	4,23 €

### KEY SHELL OTTONE RUBBER PAD ALFA ROMEO



Bottone apri/chiudi e bagagliaio.



Cod.	Descrizione	Conf.	Prezzo
SCARRS8	3 bottoni	1	53,83 €

### DUPLICATRICE MECCANICA POKER PRO



Duplicatrice interamente automatica per chiavi piatte. Con lettore ottico, controllo automatizzato della velocità di movimento e schermo protettivo.



Cod.	LxPxH mm	Conf.	Prezzo
SMPOKERPRO	320x410x340	1	8.977,00 €

### DUPLICATRICE MECCANICA MAPPA E DOPPIA MAPPA TARGA 2000P



Duplicatrici per chiavi mappa e doppia mappa maschio e femmina e chiavi a pompa. Design compatto, componenti alta qualità, movimentazione su boccole sinterizzate, leveraggi ergonomici, tolleranze centesimali di taglio.



Cod.	LxPxH mm	kg	Conf.	Prezzo
SMTARGA2000P	345x550x330	16,5	1	5.521,00 €

### DUPLICATRICE MECCANICA OMNIA 650



Duplicatrice professionale per chiavi a mappa e doppia mappa (maschio e femmina). Adatta anche per l'uso su chiavi in ottone.



Cod.	LxPxH mm	kg	Conf.	Prezzo
SMOMNIA650	395x550x320	32	1	7.698,00 €

### DUPLICATRICE MECCANICA LASER MATRIX EVO S



Duplicatrice meccanica di precisione per chiavi punzonate e laser. Con morsetto a tre posizioni, sistema di taratura elettromeccanico, movimentazione fluida del carrello e ghiera di regolazione micrometrica.



Cod.	LxPxH mm	kg	Conf.	Prezzo
SMMATRIXEVOS	310x400x470	24,6	1	6.622,00 €

## TESTA ELETTRONICA CON ADATTATORE



Cod.	Modello	Conf.	Prezzo
SCMHGTI	GTI	1	43,80 €
SCMHTA	CMH-TA	1	9,40 €

## MULTI TRANSPONDER GTI WEDGE



Transponder multifunzione per la clonazione delle più comuni chiavi per auto e moto.



Cod.	Modello	Conf.	Prezzo
SC03927	GTI WEDGE	1	36,50 €

## TRANSPONDER PHILIPS T490 CRYPTO-3



Per la clonazione e programmazione chiavi auto e radiocomandi.



Cod.	Modello	Conf.	Prezzo
SC104902	T490 CRYPTO-3	1	26,32 €

## TRANSPONDER T5 SOKYMAT



Per la clonazione e programmazione chiavi auto e radiocomandi.



Cod.	Modello	Pz	Conf.	Prezzo
SC01556PK5	T5 SOKYMAT	5	1	39,14 €

## TRANSPONDER T48 MEG CRY MAGIC GLASS



Per la clonazione e programmazione chiavi auto e radiocomandi.



Cod.	Modello	Conf.	Prezzo
SC03620	T48 MEG CRY MAGIC GLASS	1	32,17 €

## TRANSPONDER T50 PH CRY MULTI WEDGE



Transponder wedge multi-funzione per la copia di transponder Philips® Crypto (ID41, ID42, ID4W e ID45) per specifici modelli veicolo Ford®, LDV®, Nissan®, Peugeot®, Seat® e Volkswagen®. Compatibile con i dispositivi di clonazione transponder Silca RW4 Plus e Fast Copy Plus.



Cod.	Modello	Conf.	Prezzo
SC03800	T50 PH CRY MULTI WEDGE	1	26,32 €

## TRANSPONDER T80 CLONING WEDGE



Transponder wedge multi-funzione per la clonazione e programmazione delle chiavi auto e moto più diffuse.



Cod.	Modello	Conf.	Prezzo
SC03980	TEX.CRY80 CLONING WEDGE	1	26,32 €

## SCANNER RADIOCOMANDO EASY SCAN PLUS



Portatile e facile da usare. Ti guida nelle operazioni di copia dei radiocomandi residenziali, determinando se il radiocomando originale è duplicabile e indicando quale Air4 Silca utilizzare.



Cod.	Modello	Conf.	Prezzo
SD746776ZB	EASY SCAN PLUS	1	996,00 €

## RADIOCOMANDO REMOTE AIR4 V 64



Portata superiore del 25% rispetto ai modelli precedenti. Copia 'faccia a faccia' più veloce. Più memoria interna. Consente di duplicare radiocomandi a codice fisso e rolling con frequenze tra 433.92 e 868.35 MHz (AM/FM).



Cod.	Modello	Conf.	Prezzo
SARKE15400	AIR4 V 64	1	36,50 €

## RADIOCOMANDO REMOTE AIR4 L



Consente di duplicare radiocomandi a codice fisso e molti radiocomandi a codice rolling che utilizzano una frequenza di 433.92 MHz (AM).



Cod.	Modello	Conf.	Prezzo
SARKE10000	AIR4 L	1	25,25 €

## RADIOCOMANDO REMOTE AIR4 V 128



Copia i radiocomandi Cardin® 128bit. Duplica i radiocomandi FAAC® e Genius®. Consente di duplicare radiocomandi a codice fisso e rolling con frequenze tra 433.92 e 868.35 MHz (AM/FM). Maggiore memoria interna.



Cod.	Modello	Conf.	Prezzo
SARKE25200	AIR4 V 128	1	42,25 €

### RADIOCOMANDO UNIVERSALE DOOR



4 banchi per memorizzare fino a 4 diversi cancelli. Autoappendente. Mantiene la memoria nel cambio batterie. Indicatore luminoso. Facile da programmare. Batterie incluse. Colore nero.



Cod.	Modello	Conf.	Prezzo
929011	nero Mhz 433,92	1	14,70 €

### RADIOCOMANDO UNIVERSALE PASSEPARTOUT



4 banchi per memorizzare fino a 4 diversi cancelli. Autoappendente. Mantiene la memoria nel cambio batterie. Indicatore luminoso. Facile da programmare. Batterie incluse. Colore avorio.



Cod.	Modello	Conf.	Prezzo
929012	universale - MHz 433,92/868	1	24,45 €

### RADIOCOMANDO MAGIKO UNIVERSAL



Radiocomando apricancello rolling code autoapprendente. Copre tutti i modelli delle più importanti aziende del settore. Memorizza fino a 4 rolling code diversi.



Cod.	Frequenza	Conf.	Prezzo
929022	433,92 / 868	1	27,10 €

### RADIOCOMANDO AUTOAPPRENDENTE A RADIOFREQUENZA ALADINO



Duplica la maggior parte dei radiocomandi per cancello a norma CE. Può memorizzare fino a 4 radiocomandi diversi. Facile da programmare. Dotato di indicatore luminoso.



Cod.	Modello	Conf.	Prezzo
929096	universale - MHz 433	1	12,65 €

### RADIOCOMANDO NL/SMILE C



Smile-copy 2 canali trasmettitore 2 canali completo di supporto autoapprendimento codici standard fino a 96 bit, batt. 6 Volt. Disponibili in 11 colori. VIDEO DUPLICAZIONE RADIOCOMANDI IN SCHEDA TECNICA.



Cod.	Modello	Conf.	Prezzo
470021	NL/SMILE C - Mhz 433,92	1	25,60 €

### RADIOCOMANDO NL/SMILE CB ROLLING+FISSI



Smile-copy 2 canali trasmettitore 2 canali. Batt. 6 Volt. VIDEO DUPLICAZIONE RADIOCOMANDI IN SCHEDA TECNICA. Può duplicare radiocomandi rolling code e codici fissi in autoapprendimento.



Cod.	Modello	Conf.	Prezzo
470140	NL/SMILE CB - Mhz 433	1	26,90 €

### RADIOCOMANDO NL/EKO-C



Smile-copy 2 canali trasmettitore 2 canali completo di supporto autoapprendimento codici standard fino a 96 bit, batt. 6 Volt. Disponibili in 11 colori. VIDEO DUPLICAZIONE RADIOCOMANDI IN SCHEDA TECNICA.



Cod.	Modello	Conf.	Prezzo
470030	NL/EKO C - Mhz 433,92	1	18,80 €

### RADIOCOMANDO NL/SWING



Smile-copy 2 canali trasmettitore 2 canali completo di supporto autoapprendimento codici standard fino a 96 bit, batt. 6 Volt. Disponibili in 11 colori. VIDEO DUPLICAZIONE RADIOCOMANDI IN SCHEDA TECNICA.



Cod.	Modello	Conf.	Prezzo
470022	NL/SWING - Mhz 433,92	1	24,85 €

### RADIOCOMANDO NL/SWING 868 ROLLING+FISSI



Smile-copy 2 canali trasmettitore 2 canali. Batt. 6 Volt. VIDEO DUPLICAZIONE RADIOCOMANDI IN SCHEDA TECNICA. Può duplicare radiocomandi rolling code e codici fissi in autoapprendimento.



Cod.	Modello	Conf.	Prezzo
470141	NL/SWING - Mhz 868	1	26,90 €

### RADIOCOMANDO NL/SMART CD4



Trasmettitore universale, 4 canali doppio led. Autoapprendimento codici standard fino a 400 bit, batt. 12 Volt. VIDEO DUPLICAZIONE RADIOCOMANDI IN SCHEDA TECNICA.



Cod.	Modello	Conf.	Prezzo
470023	NL/SMART CD4 - universale	1	24,85 €

### RADIOCOMANDO NL/BANDY CD4

Trasmettitore universale, 4 canali doppio led. Autoapprendimento codici standard fino a 400 bit, batt. 12 Volt. Disponibile in 8 colori. VIDEO DUPLICAZIONE RADIOCOMANDI IN SCHEDA TECNICA.



Cod.	Modello	Conf.	Prezzo
470029	NL/BANDY CD4 - Mhz 433.92	1	25,00 €

### RADIOCOMANDO NL/BAD-C

Resistente alla pioggia. 3 canali. Autoapprendimento codici standard fino a 400 bit. Alimentazione 12V.



Cod.	Modello	Conf.	Prezzo
470036	NL/BAD-C - Mhz 433	1	17,15 €

### RADIOCOMANDO NL/BANDY ONE4

Trasmettitore universale, 4 canali doppio led. Autoapprendimento codici standard fino a 400 bit, batt. 12 Volt. VIDEO DUPLICAZIONE RADIOCOMANDI IN SCHEDA TECNICA.



Cod.	Modello	Conf.	Prezzo
470107	NL/BANDY ONE4 - Mhz 433/868	1	26,90 €

### RADIOCOMANDO NL/BANDY ONE4 ROLLING+FISSI

Trasmettitore universale, 4 canali doppio led. Batt. 12 Volt. VIDEO DUPLICAZIONE RADIOCOMANDI IN SCHEDA TECNICA. Può duplicare radiocomandi rolling code e codici fissi in autoapprendimento.



Cod.	Modello	Conf.	Prezzo
470143	NL/BANDY ONE4 - Mhz 433/868	1	27,70 €

### RADIOCOMANDO NL/SMART ONE6

Trasmettitore universale, 6 canali doppio led. Autoapprendimento codici standard fino a 400 bit, batt. 12 Volt. VIDEO DUPLICAZIONE RADIOCOMANDI IN SCHEDA TECNICA.



Cod.	Modello	Conf.	Prezzo
470083	NL/BANDY ONE6 - Mhz 433/868	1	31,10 €

### RADIOCOMANDO HORMANN

2 canali.



Cod.	Modello	Conf.	Prezzo
470120	H/436754 - MHz 868	10	83,70 €

### RADIOCOMANDO TX 4 CANALI INNESTO QUARZO

Per codici standard fino a 400 bit.



Cod.	Modello	Conf.	Prezzo
470080	NL/ROX QCD4 - quarzato universale	1	32,40 €

### RADIOCOMANDO NL/BOSS-QC2

Trasmettitore 2 canali predisposto per l'innesto del quarzo. Autoapprendimento e autogenerazione codici standard. Alimentazione 12V.



Cod.	Modello	Conf.	Prezzo
470034	NL/BOSS-QC2 - quarzato	1	27,70 €

### RADIOCOMANDO NL/OTTO

Trasmettitore universale, 2 canali. Batt. 12 Volt. VIDEO DUPLICAZIONE RADIOCOMANDI IN SCHEDA TECNICA. Può duplicare radiocomandi rolling code e codici fissi in autoapprendimento.



Cod.	Modello	Conf.	Prezzo
470142	NL/OTTO - Mhz 433	1	23,65 €

### RADIOCOMANDO NL/SMART QC2

Trasmettitore 2 canali predisposto per l'innesto del quarzo. Autoapprendimento e autogenerazione codici standard, batt. 12 Volt. Video duplicazione radiocomandi in scheda tecnica



Cod.	Modello	Conf.	Prezzo
470024	NL/SMART QC2 - quarzato	1	25,65 €

## RADIOCOMANDO NL/SMART QCA

Trasmettitore 4 canali predisposto per l'innesco del quarzo. Autoapprendimento e autogenerazione codici standard, batt. 12 Volt. VIDEO DUPLICAZIONE RADIOCOMANDI IN SCHEDA TECNICA.



Cod.	Modello	Conf.	Prezzo
470028	MHz 433,92 - quarzato	1	27,70 €

## RADIOCOMANDO NL/SMART QCD4 ROLLING+FISSI

Trasmettitore TX4 canali. Batt. 12 Volt. VIDEO DUPLICAZIONE RADIOCOMANDI IN SCHEDA TECNICA. Può duplicare radiocomandi rolling code e doppia frequenza in autoapprendimento..



Cod.	Modello	Conf.	Prezzo
470144	MHz 433,92 - quarzato	1	32,30 €

## RADIOCOMANDO ALLMATICROLLING CODE

Microtrasmettitore ultrasottile a 3 canali con supporto di serie. Alimentazione 3V con una batteria al litio CR2032 di lunga durata. OVER è un prodotto raffinato, di grande tecnologia e gradevole design. Portata: circa 80 mt.



Cod.	Modello	Conf.	Prezzo
470075	AL/12005380 - Mhz 433,92	1	26,50 €

## RADIOCOMANDO MULTIFREQUENZA CARTY-R ROLLING+FISSI

Rende possibile l'unificazione fino a quattro trasmettitori con codice diverso, codice fisso, multi-frequenza, codice rolling, uno per ogni tasto.



Cod.	Modello	Conf.	Prezzo
059465	4 canali - multifrequenza	1	26,90 €

## LETTORE DI FREQUENZA COPY CONTROL 2.0

Una soluzione evoluta per copiare e programmare radiocomandi. Semplice e intuitivo all'uso. Funzioni: identificazione codice Rolling Cod, trasferimento codice, controllo BIT, frequenzimetro, taratura comandi, analizzatore di spettro, verifica copertura.



Cod.	Modello	Conf.	Prezzo
059566	copy control 2.0	1	340,50 €

## QUARZO DI RICAMBIO PER COPY CONTROL 2.0

Cod.	Modello	Conf.	Prezzo
470001	Mhz 26.995	1	2,00 €
470002	Mhz 26.720	1	2,00 €
470003	Mhz 27.545	1	2,00 €
470004	Mhz 29.700	1	2,00 €
470005	Mhz 29.800	1	2,00 €
470006	Mhz 29.875	1	2,00 €
470007	Mhz 30.545	1	2,00 €
470008	Mhz 30.875	1	2,00 €
470009	Mhz 30.900	1	2,00 €
470010	Mhz 30.925	1	2,00 €
470011	Mhz 33.100	1	2,00 €
470012	Mhz 40.665	1	2,00 €
470013	Mhz 40.685	1	2,00 €
470014	Mhz 30.155	1	2,00 €
470015	Mhz 27.745	1	2,00 €
470016	Mhz 30.075	1	2,00 €
470017	Mhz 26.975	1	2,00 €
470018	Mhz 27.575	1	2,00 €
470019	Mhz 27.095	1	2,00 €
470020	Mhz 27.195	1	2,00 €

## RADIOCOMANDO BENINCA TO.GO

Trasmettitore 4 canali. Codifica Rolling Code. Alimentazione 12V.



Cod.	Modello	Conf.	Prezzo
470042	B/9863066 - Mhz 433,92	1	31,10 €

## RADIOCOMANDO BFT MITTO

Trasmettitore 2 canali. Codifica Rolling Code. Alimentazione 12V.



Cod.	Modello	Conf.	Prezzo
470046	BF/D111904 - Mhz 433,92	1	33,50 €

## RADIOCOMANDO BFT MITTO

Trasmettitore 4 canali. Codifica Rolling Code. Alimentazione 12V.



Cod.	Modello	Conf.	Prezzo
470047	BF/D111906 - Mhz 433,92	1	37,80 €

# I MAGNIFICI 5

IL SUPERPOTERE NELLE TUE MANI

BANDY  
-ONE



OTTO  
-C



SWING  
-CE



SMILE  
-CB



SMART  
-QCD4



MADE IN ITALY



## RADIOCOMANDO CAME

Trasmettitore 2 canali rolling-code.



Cod.	Modello	Conf.	Prezzo
470035	CA/001AT02 - Mhz 433,92	1	50,70 €

## RADIOCOMANDO CAME TOP

2 canali.



Cod.	Modello	Conf.	Prezzo
470097	CA/001TOP - 432EE - Mhz 433	1	36,30 €

## RADIOCOMANDO CARDIN

4 canali.



Cod.	Modello	Conf.	Prezzo
470053	C/TXQ449400 - Mhz 433,92	1	32,30 €

## RADIOCOMANDO CARDIN

2 canali.



Cod.	Modello	Conf.	Prezzo
470057	C/TXQ486200 - Mhz 868,3	1	33,80 €

## RADIOCOMANDO CARDIN

2 canali.



Cod.	Modello	Conf.	Prezzo
470055	C/TXQ504C2 - MHz 433,92	1	37,60 €

## RADIOCOMANDO CARDIN

2 canali.



Cod.	Modello	Conf.	Prezzo
470058	C/TRS435200 - Mhz 433,92	1	29,70 €

## RADIOCOMANDO CARDIN

4 canali.



Cod.	Modello	Conf.	Prezzo
470059	C/TRS435400 - Mhz 433,92	1	35,00 €

## RADIOCOMANDO DITEC 4

TX 4 funzioni fisso.



Cod.	Modello	Conf.	Prezzo
470051	D/ZEN 4- Mhz 433,92	1	34,60 €

## RADIOCOMANDO ENTREMATIc ZEN 4

4 funzioni.



Cod.	Modello	Conf.	Prezzo
470052	D/ZEN 4 - Mhz 433,92	1	32,30 €

## RADIOCOMANDO ELVOX

2 canali.



Cod.	Modello	Conf.	Prezzo
470078	EV/ETR5 - Mhz 433,92	1	51,30 €

## RADIOCOMANDO FAAC SLHLR

2 canali.



vecchi modelli



Cod.	Modello	Conf.	Prezzo
470067	FC/787007 - Mhz 433,92	1	34,30 €

**RADIOCOMANDO FAAC SLHLR**

2 canali.



vecchi modelli

Cod.	Modello	Conf.	Prezzo
470068	FC/787009 - Mhz 868,35	1	37,80 €

**RADIOCOMANDO FADINI SITI**

2 canali.



Cod.	Modello	Conf.	Prezzo
470104	FA/6313 - Mhz 433,92	1	35,10 €

**RADIOCOMANDO FAAC SLHLR**

4 canali.



vecchi modelli

Cod.	Modello	Conf.	Prezzo
470069	FC/787010 - Mhz 868,35	1	40,40 €

**RADIOCOMANDO GENIUS KILO**

2 canali.



Cod.	Modello	Conf.	Prezzo
470095	GE/6100332 - Mhz 868,35	1	33,10 €

**RADIOCOMANDO FAAC SLHLR**

4 canali.



vecchi modelli

Cod.	Modello	Conf.	Prezzo
470112	FC/7870081 - Mhz 433,92	1	40,40 €
470132	FC/7870071 - Mhz 433,92	1	35,90 €

**RADIOCOMANDO GIBIDI DOMINO**

4 canali.



Cod.	Modello	Conf.	Prezzo
470096	G/AU03000 - Mhz 433,92	1	31,80 €

**RADIOCOMANDO FADINI DIVO 71**

4 canali.



Cod.	Modello	Conf.	Prezzo
470061	FA/7113SL - quarzo - Mhz 433	1	36,50 €

**RADIOCOMANDO NICE ERA**

2 canali.



Cod.	Modello	Conf.	Prezzo
470111	NC/INTI2 - Mhz 433,92 (nero)	1	32,30 €
470118	NC/INTI2Y - Mhz 433,92 (giallo)	1	32,30 €
470115	NC/ONE2E - Mhz 433,92	1	37,20 €

**RADIOCOMANDO FADINI BIRIO**

2 canali.



Cod.	Modello	Conf.	Prezzo
470062	FA/8613 - Mhz 868,35	1	35,10 €

**RADIOCOMANDO NICE**

2 canali.



Cod.	Modello	Conf.	Prezzo
470070	NC/FL02R - Mhz 433,92	1	30,60 €



## RADIOCOMANDO NICE

4 canali.



Cod.	Modello	Conf.	Prezzo
470071	NC/FLO4R - Mhz 433,92	1	34,30 €

## ANELLO PORTACHIAVI PIATTO DORATO

DIESE



Cod.	Ø mm	Conf.	Prezzo
841000	33	50	1,57 €

## RADIOCOMANDO NICE SMILLO ROLLIN CODE



Cod.	Modello	Conf.	Prezzo
470073	2 canali - NC/SM2 - Mhz 433,92	1	37,60 €
470076	4 canali - NC/SM4 - Mhz 433,92	1	40,10 €

## ANELLO PORTACHIAVI

Acciaio nichelato.



DIESE

Cod.	mm	Conf.	Prezzo
016255	20	200	0,02 €
005543	30	200	0,04 €
005544	35	100	0,06 €

## RADIOCOMANDO NICE ONE



Cod.	Modello	Conf.	Prezzo
470116	NC/ON2FM - Mhz 433,92	1	39,70 €

## ANELLI PORTACHIAVI ASSORTITI



Cod.	Pz	Conf.	Prezzo
SI799	72	1	9,04 €

## RADIOCOMANDO SOMMER

2 canali.



Cod.	Modello	Conf.	Prezzo
470098	SO/4014 - Mhz 433,92	1	68,00 €

## PORTACHIAVI + CATENELLA CROMO



DIESE

Cod.	cm	Conf.	Prezzo
841025	53	20	1,45 €

## RADIOCOMANDO SOMMER

4 canali.



Cod.	Modello	Conf.	Prezzo
470102	SO/4013 - Mhz 433,92	1	68,00 €

## SEGNACHIAVE PIENO



DIESE

Cod.	Pz	Conf.	Prezzo
841005	300	1	15,00 €

**MOSCHETTONE PICCOLO SMALTATO + ANELLO**

DIESE



Cod.	mm	Conf.	Prezzo
841015	60	30	2,10 €

**PORTACHIAVI IN PLASTICA COLORATA CON MOSCHETTONE**

SIM



Cod.	Descrizione	Conf.	Prezzo
SI250	con moschettone	200	0,10 €

**MOSCHETTONE PICCOLO**

DIESE



Cod.	mm	Conf.	Prezzo
841020	60	50	0,98 €

**PORTACHIAVI IN PLASTICA COLORATA CON GANCIO S**

SIM



Cod.	Descrizione	Conf.	Prezzo
SI251	con gancio S	200	0,08 €

**PORTACHIAVI + CATENELLA ORO**

DIESE



Cod.	cm	Conf.	Prezzo
841026	47	20	8,98 €

**PORTACHIAVI MISTI**

Vari modelli e colori.



Cod.	Descrizione	Conf.	Prezzo
059350	12 soggetti	1	55,30 €
059351	12 soggetti	1	55,30 €
059352	12 soggetti	1	55,30 €
059353	12 soggetti	1	55,30 €

**PORTACHIAVI IN PLASTICA COLORATA CON GIVOLARE**

SIM



Cod.	Descrizione	Conf.	Prezzo
SI252	con givolare	200	0,17 €

**PORTACHIAVI EMOJI**

ALFA

Portachiavi in metallo.  
Fantasie assortite.



Cod.	Descrizione	Conf.	Prezzo
SAVK7241	12 soggetti	1	62,30 €