

casalinghi e idraulica

TANICHE

VASETTI

ACCESSORI CASA

STENDIBIANCHERIA

BIDONI

VENTILATORI

ACCENDIGAS

RACCORDI GAS

RACORDERIA

DOCETTE

RUBINETTERIA

ACCESSORI LAVANDINO

FILTRI



PANIERE PLASTICA OVALE



Cod.	Descrizione	Conf.	Prezzo
003402	manico incastro	10	9,18 €
038481	ricambio manico ovale incastro	10	1,95 €

CESTA TONDO MANICO PLASTICA



Cod.	Descrizione	lt	Conf.	Prezzo
4670050	in plastica	16	10	6,62 €
4670052	in plastica	20	10	8,18 €
009513	manico di ricambio per panierino da 20 lt		1	3,35 €

CESTO TONDO MANICO ACCIAIO



Cod.	Descrizione	lt	Conf.	Prezzo
010688	in metallo	15	10	10,25 €

MANIGLIA MASTELLO UVA



Cod.	Descrizione	Conf.	Prezzo
015169	da uva	10	3,67 €

MASTELLO UVA VINACCIA



Cod.	Descrizione	lt	cm	Conf.	Prezzo
004209	ovale	80	65x32h	1	28,60 €
059589	tondo	110	71x39h	1	29,40 €
059590	tondo	230	85x55h	1	42,90 €
059591	tondo	275	110x35h	1	58,00 €
059592	tondo	350	96x73h	1	62,70 €
059593	tondo	500	104x82h	1	82,40 €
059594	tondo	750	122x82h	1	127,00 €
059588	tondo	1000	140x90h	1	188,00 €

FILTRO PLASTICA SVINAROLA PER MASTELLO



Cod.	Descrizione	Conf.	Prezzo
041452	in plastica	1	4,68 €

RUBINETTO MASTELLO UVA



Cod.	Descrizione	Conf.	Prezzo
041451	attacco 1"	1	11,75 €

SECCHIO AGRICOLO MANICO IN FERRO



Cod.	lt	Conf.	Prezzo
013537	15	1	4,80 €

CASSA RETTANGOLARE SOVRAPPONIBILE



Cod.	cm	lt	Conf.	Prezzo
052726	52x42x29	50	100	12,75 €
052727	63x44x33	65	100	15,05 €

CASSETTA AGRICOLA IMPILABILE SEMICHIUSA



Cod.	cm	lt	Conf.	Prezzo
029815	55x36x31	40	150	6,90 €

CASSETTA AGRICOLA STANDARD SEMICHIUSA



Cod.	cm	lt	Conf.	Prezzo
029814	51x35x31	40	90	7,19 €

SESSOLA RETTANGOLARE



Cod.	cm	Conf.	Prezzo
S6031.43	43x15	6	3,16 €

SESSOLA ROTONDA



Cod.	cm	Conf.	Prezzo
S6136.19	19	48	1,10 €
S6136.24	24	36	1,29 €
S6136.29	29	36	1,51 €
S6136.34	34	24	2,00 €
S6136.38	38	24	2,38 €
S6136.42	42	24	2,99 €

SESSOLA PALOTTO QUADRA

Colore rosso.



Cod.	cm	Conf.	Prezzo
4670100	38	60	5,22 €

SESSOLA TONDA ALLUMINIO BRILLANTATA



Cod.	cm	Conf.	Prezzo
015230	12x6	1	5,71 €
008238	20x10	1	12,65 €
008247	23x12	1	19,95 €
008344	26x14	1	22,25 €
008554	30x16	1	22,25 €

RUBINETTO MONTATO SU TAPPO



Cod.	Descrizione	Conf.	Prezzo
003474	plastica	1	6,47 €

TAPPO PER TANICA



Cod.	Descrizione	Conf.	Prezzo
059663	con guarnizione	1	1,21 €

MOLTO VOLUME IN POCO SPAZIO

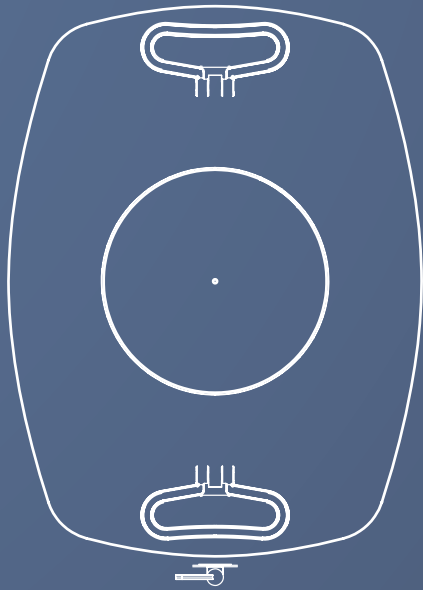

HDPE

100% RICICLABILE



PER ALIMENTI

**NUOVA FORMA
SALVASPAZIO**



PASSIONE E TRADIZIONE



Made in Italy



Scan me

TANICA NORMALE

Prodotto in polietilene ad alta densità per uso alimentare.



Cod.	Portata lt	Conf.	Prezzo
009814	2	12	1,82 €
003465	3	12	2,25 €
003466	5	4	3,20 €
003467	10	4	5,14 €
003468	15	4	7,21 €
003469	20	4	8,04 €
003470	25	4	9,25 €
003471	30	4	10,75 €

TANICA NORMALE CON RUBINETTO

Prodotto in polietilene ad alta densità per uso alimentare.



Cod.	Portata lt	Conf.	Prezzo
003472	10	4	13,40 €
003473	20	4	16,80 €

RUBINETTO TANICA BIANCO



Cod.	Descrizione	Conf.	Prezzo
063707	plastica	1	3,16 €

FUSTINO PLASTICA DEMETRA

Con manico in plastica e rubinetto.



Cod.	portata lt	cm	Conf.	Prezzo
063714	5	20x26h	1	13,40 €
059142	10	23x32h	1	14,80 €
059143	15	27x37h	1	17,90 €
059144	20	29x41h	1	20,15 €
059145	25	30x45 h	1	24,95 €
059146	50	36x56h	1	40,30 €

RUBINETTO PER FUSTINO DEMETRA



Cod.	n°	Misura	Descrizione	Conf.	Prezzo
061850	1	lt 5-20 - 3/8"	piccolo	1	3,07 €
061851	2	lt 25-100- 3/4"	grande	1	3,41 €
061852	3	lt 24 - 3/4"	con dado	1	3,27 €

COPERCHIO PER FUSTINO DEMETRA



Cod.	Misura	Descrizione	Conf.	Prezzo
061847	lt 5-25 - 12"	sfiato e tappo	1	6,07 €
061848	lt 50-100 - 20"	sfiato e tappo	1	8,72 €
061849	lt 5-20 - 12"	M85	1	1,48 €

TAPPO PER FUSTINO DEMETRA



Cod.	Misura	Descrizione	Conf.	Prezzo
061853	lt 5-20	piccolo	1	0,88 €
061854	lt 25-100	grande	1	1,24 €

COLMATORE

In plastica.



Cod.	Descrizione	Conf.	Prezzo
4670170	trasparente corto - attacco conico	1	10,30 €
018650	trasparente corto - attacco flangia	1	12,30 €
018507	trasparente lungo - attacco flangia	1	12,10 €
4670165	trasparente lungo - attacco conico	1	11,15 €

TAPPO IDRAULICO DAMIGIANA

Per fermentazione e stoccaggio del vino in damigiana.



Cod.	Descrizione	Conf.	Prezzo
4670158	damigiana da 35 lt	25	1,81 €
4670160	damigiana da 54 lt	25	1,57 €

CILINDRO GRADUATO COLLO ALTO

In polipropilene graduate esternamente.



Cod.	ml	Conf.	Prezzo
CO.361/A	500	1	3,59 €
CO.361/B	250	1	3,17 €
CO.361/C	100	1	1,94 €
CO.361/D	50	1	1,68 €

IMBUTO PLASTICA CON FILTRO

In polipropilene ad alta intensità.



Cod.	Ø cm	Conf.	Prezzo
4670190	15	25	2,28 €
4670192	18	15	2,74 €
4670195	21	12	3,95 €

IMBUTO PLASTICA

In polipropilene ad alta intensità.



Cod.	Ø cm	Conf.	Prezzo
4670196	10	5	0,72 €
4670197	12	5	0,92 €
4670198	14	36	1,11 €
4670199	16	24	1,36 €
4670200	18	5	2,08 €
4670205	20	12	2,22 €
4670208	22	10	2,50 €
4670210	24	10	2,75 €
4670215	26	10	3,21 €
4670220	30	10	4,38 €

FILTRO PER IMBUTO BIANCO



Cod.	Ø cm	Conf.	Prezzo
063694	10	1	4,06 €
063695	12	1	4,52 €

IMBUTO A TORTIGLIONE



Cod.	Ø cm	Conf.	Prezzo
4670225	15	6	3,64 €

IMBUTO AUTOREGOLATORE

Con filtro a gancio. Per un livello automatico delle bottiglie.



Cod.	Ø cm	Conf.	Prezzo
4670230	11	6	6,25 €

IMBUTO CURVA FLESSIBILE

Senza beccucci rigido.



Cod.	Ø mm	Conf.	Prezzo
4670500	21	12	8,58 €
064025	26	12	9,62 €

FILTRO IN COTONE

Utilizzare con imbuto a tortiglione.



Cod.	Descrizione	Conf.	Prezzo
4670235	puro cotone	10	4,46 €

FILTRO DI CARTA PIEGHETTATO

Per filtrare liquore e vino. Utilizzare con imbuto a tortiglione.



Cod.	Descrizione	Pz.	Conf.	Prezzo
4670240	piegati a mano	100	1	141,00 €

CARAFFA RIGIDA GRADUATA



Cod.	Portata lt	Conf.	Prezzo
S6006.010	1	48	2,49 €
S6006.020	2	60	2,71 €
S6006.030	3	20	3,46 €
S6006.050	5	20	4,30 €

CARAFFA RIGIDA GRADUATA



Cod.	lt	Conf.	Prezzo
CO.387	1	1	2,33 €
CO.397	2	1	3,52 €
CO.386	3	1	4,40 €
CO.394	5	1	6,85 €

BOCCALE DOSATORE



Cod.	lt	Descrizione	Conf.	Prezzo
4670180	0,5	-	12	1,94 €
4670185	1	graduato	12	2,82 €

CARAFFA GRADUATA



Cod.	lt	Conf.	Prezzo
4670485	1	12	8,08 €
4670490	2,5	12	9,12 €
4670495	5	12	11,55 €

AMPOLLA A CANNA CURVA



Cod.	ml	Conf.	Prezzo
CO.381/A	250	1	4,60 €

LEVAOLIO



Cod.	Descrizione	Conf.	Prezzo
4670175	tradizionale	12	4,69 €

TRAVASATORE

Per alimenti con innesco a soffio.
Con rubinetto minus.



Cod.	Tubo cm	Conf.	Prezzo
4670261	95	10	6,34 €

TRAVASATORE

Per alimenti con innesco a soffio.
Con rubinetto pulsante.



Cod.	Tubo cm	Conf.	Prezzo
4670260	115	10	8,55 €

TRAVASATORE A POLMONE

Per alimenti con innesco a polmone. Con rubinetto minus.



Cod.	Tubo cm	Conf.	Prezzo
4670262	95	10	8,85 €

TRAVASATORE AUTOMATICO AUTOREGOLATORE

Per alimenti con innesco a soffio. Con rubinetto automatico autoregolatore.



FERRARI

Cod.	Tubo cm	Conf.	Prezzo
4670263	115	10	16,15 €

TRAVASATORE A POLMONE

Per alimenti con innesco a polmone. Con rubinetto pulsante. In confezione appendibile.



FERRARI

Cod.	L tubo cm	Conf.	Prezzo
4670270	101	10	10,50 €

RUBINETTO TRAVASATORE



FERRARI

Cod.	Descrizione	Conf.	Prezzo
4670151	mod. minus	10	1,30 €

RUBINETTO PER CONTENITORE PICCOLO



FERRARI

Cod.	Descrizione	Conf.	Prezzo
4670140	28E - Ø 3/4"	10	1,99 €

RUBINETTO A PULSANTE



FERRARI

Cod.	Descrizione	Conf.	Prezzo
4670155	mod. E9	10	2,62 €

RUBINETTO PER CONTENITORE GROSSO



FERRARI

Cod.	Descrizione	Conf.	Prezzo
4670145	29E - Ø 3/4"	10	3,47 €

RUBINETTO RIEMPITORE AUTOMATICO MOD. E05

Autolivellante con arresto automatico e dispositivo antischiuma.



FERRARI

Cod.	Descrizione	Conf.	Prezzo
4670150	con autoregolatore	10	9,97 €

RUBINETTO TRAVASATORE

In metallo.



FERRARI

Cod.	Descrizione	Conf.	Prezzo
4670259	semiautomatico	10	22,85 €

LAVABOTTIGLIE IDRAULICO

Rivoluzionario lavabottiglie che consente il lavaggio di bottiglioni, bottiglie, contenitori, vasi, etc. Nessun collegamento elettrico, igiene massima, nessun costo di utilizzo.



G.F.

Cod.	Descrizione	Conf.	Prezzo
GF8010	0,0153 m ³ - 1,802 kg	1	104,50 €
032032	ricambio	1	16,90 €

LAVABOTTIGLIE ROTATIVO



Cod.	Descrizione	Conf.	Prezzo
4670250	classico rotativo	10	21,65 €

SPAZZOLINO LAVA BOTTIGLIE



Cod.	Descrizione	Conf.	Prezzo
004405	scovolo e fiocco	12	1,03 €

LAVADAMIGIANE A SCOVOLO



Cod.	Descrizione	Conf.	Prezzo
4670245	semplice a scovolo	3	14,50 €

SCOLABOTTIGLIE ECO



Modello fisso.

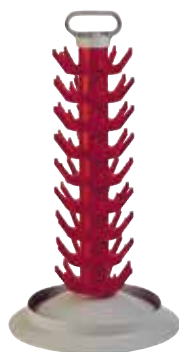

Cod.	Descrizione	Conf.	Prezzo
4670255	81 posti	4	17,75 €

**CESTELLO PORTA BOTTIGLIA
4 POSTI**



Cod.	cm	Colore	Conf.	Prezzo
050354	30x25x16	rosso	10	5,56 €
050355	30x25x16	verde	10	5,56 €

**CESTELLO PORTABOTTIGLIE
6 POSTI**



Cod.	cm	Colore	Conf.	Prezzo
050356	30x21x16	rosso	10	4,81 €
050357	30x21x16	verde	10	4,81 €

**CANTINETTA
4 RIPIANI**



Cod.	Descrizione	cm	Conf.	Prezzo
PN00654	4 ripiani	71,5x22x49,5	1	27,65 €

CANTINETTA IN LEGNO



Può contenere 18 bottiglie.
In legno.



Cod.	Descrizione	cm	Conf.	Prezzo
GA2990	6 ripiani	30x70x32	1	54,90 €

**KIT 6 BOTTIGLIE
COLORATE SWING**

Colorate. Cestello 6 posti.



Cod.	lt	Conf.	Prezzo
061410	1	1	15,00 €

**KIT 6 BOTTIGLIE
COLORATE MORESCA**

Colorate. Cestello 6 posti.



Cod.	lt	Conf.	Prezzo
061411	1	1	15,00 €

BOTTIGLIA VETRO ACQUA

cod. 038506 tappo Ø 31,5 mm.
cod. 041689 tappo Ø 35 mm.



Cod.	lt	Descrizione	Conf.	Prezzo
038506	1,5	trasparente - tappo a vite	12	1,47 €
041689	2	trasparente - tappo a vite	12	1,47 €

BOTTIGLIA VETRO COLORATO



Cod.	lt	Conf.	Prezzo
039721	1	6	1,82 €

BOTTIGLIA VETRO DA BIRRA



Cod.	lt	Conf.	Prezzo
054822	0,33	24	0,49 €
041937	0,50	20	0,54 €
038504	0,66	20	0,60 €

BOTTIGLIA VETRO ACQUA MINERALE



Cod.	lt	Descrizione	Conf.	Prezzo
038530	0,5	verde chiaro	15	0,70 €
038464	1	verde chiaro	15	0,73 €
038465	1	trasparente	15	0,73 €

FIASCO PAGLIA



Cod.	lt	Conf.	Prezzo
038520	0,75	18	2,75 €
038494	1	18	3,17 €
038495	1,5	8	3,48 €
038496	2	6	3,80 €

**BOTTIGLIA VETRO A COSTE
BIANCA**



Cod.	lt	Descrizione	Conf.	Prezzo
038505	1	tappo a scatto	15	1,07 €

BOTTIGLIA VETRO BORDOLESE



Cod.	Descrizione	lt	Conf.	Prezzo
056648	bianco	375	28	0,80 €
038463	bianco	750	24	0,61 €
038529	verde	750	24	0,60 €
038462	marrone	750	24	0,66 €

BOTTIGLIONE VETRO



Cod.	lt	Descrizione	Conf.	Prezzo
041690	2	trasparente - tappo a scatto	12	1,47 €
052979	2	verde - tappo a scatto	12	1,53 €

BOTTIGLIA SPUMANTE

TAPPO CORONA

Colore verde.



Cod.	lt	g	Conf.	Prezzo
063025	0,375	300	24	0,98 €
052427	0,75	475	20	0,81 €
052978	0,75	600	15	1,44 €
053675	0,75	900	12	1,44 €

BOTTIGLIA VETRO VIN SANTO PRIMAVERA



Cod.	ml	Conf.	Prezzo
062790	500	1	0,98 €

BOTTIGLIA VETRO LIMONCELLO

TERESA

Colore bianco.



Cod.	ml	Conf.	Prezzo
057723	250	6	1,48 €
057725	500	6	1,23 €

TAPPO A CORONA

Per bottiglie acqua e birra.
200 pz.



Cod.	lt	Ø mm	Colore	Conf.	Prezzo
4670371	1	26	oro	1	2,72 €
4670372	1	26	rosso	1	3,31 €

TAPPO A CORONA

Per bottiglie acqua e birra.
200 pz.



Cod.	lt	Ø mm	Colore	Conf.	Prezzo
4670374	1	29	giallo	1	4,60 €
4670375	2	29	oro	1	4,36 €
4670376	1	29	bianco	1	4,60 €
4670377	1	29	rosso	1	4,09 €
4670378	1	29	verde	1	4,09 €

TAPPO A CORONA CON BIDUL



Cod.	Ø mm	Colore	Pz	Conf.	Prezzo
4670380	29	oro	200	1	6,74 €
4670381	29	bianco	200	1	6,74 €
4670382	29	rosso	200	1	6,74 €
4670383	29	verde	200	1	6,74 €
4670384	29	giallo	200	1	6,74 €

TAPPO A CORONA CON BIDUL LUNGO



Cod.	Ø mm	Colore	Pz	Conf.	Prezzo
4670386	29	oro	100	1	4,32 €
4670387	29	bianco	100	1	4,32 €
4670388	29	rosso	100	1	4,32 €
4670389	29	verde	100	1	4,32 €

TAPPO A CORONA MAXITENUTA

Per vini spumanti. Assicura ottima resistenza alla pressione.



Cod.	Ø mm	Colore	Pz	Conf.	Prezzo
4670520	29	oro	200	1	11,20 €
4670525	29	rosso	200	1	11,20 €
4670530	29	verde	200	1	11,20 €

TAPPO BOTTIGLIA IN FILO



Cod.	Descrizione	Conf.	Prezzo
004569	1-2 lt	100	0,13 €
004570	5 lt	1	0,32 €

GUARNIZIONE BOTTIGLIA



Cod.	Descrizione	Conf.	Prezzo
001874	1 lt - 1 kg	1	9,79 €
008042	5 lt - 1 kg	1	12,35 €

TAPPO BOTTIGLIA SPUMANTE SENZA TESTA

Per vini fermi. Si toglie con normale levatappi.



Cod.	Pz	Conf.	Prezzo
4670360	100	1	5,49 €

TAPPO PLASTICA

Gambo alettato.



Cod.	Pz	Conf.	Prezzo
4670365	100	1	6,52 €

TAPPO LISCIO MAXI TENUTA

Gambo liscio.



Cod.	Pz	Conf.	Prezzo
4670369	100	20	7,87 €

SOTTOTAPPO IN PLASTICA CON BIDUL



Cod.	Pz	Conf.	Prezzo
4670370	200	10	3,84 €

GABBIETTA PER TAPPI A FUNGO



Cod.	Pz	Conf.	Prezzo
4670350	100	12	3,77 €

TAPPO BOTTIGLIA ESPANSIONE 2 GOMME



Cod.	Descrizione	Pz	Conf.	Prezzo
4670425	sfusi	1	100	0,86 €
4670420	blister	3	8	4,35 €

TAPPO ESPANSIONE LEX

Due gomme.



Cod.	Descrizione	Pz	Conf.	Prezzo
4670440	2 gomme	18	1	32,70 €
4670435	2 gomme	2 in blister	8	4,78 €

TAPPO BECCUCCIO DOSATORE



Cod.	Descrizione	Conf.	Prezzo
008779	blister 2 pz	12	8,56 €

TAPPO DAMIGIANA



FERRARI

Cod.	lt	Ø mm	Pz	Conf.	Prezzo
042684	5	44	100	1	9,46 €
003529	25	59 (60)	100	1	10,50 €
042683	54	77	100	1	10,40 €

**TAPPO SINTETICO
EXPANCORK FIRST**

Adatto all'imbottigliamento di vini fermi, shelf life 6-12 mesi.



Cod.	mm	Pz	Conf.	Prezzo
4670302	23x38	100	1	8,91 €

**TAPPO SUGHERO
MICROAGGLOMERATO**

Paraffinati pronti all'uso.



FERRARI

Cod.	mm	Pz	Conf.	Prezzo
4670330	24x38	100	6	8,24 €

TAPPO SUGHERO TIPO A

Paraffinati pronti per l'uso.



Cod.	mm	Pz	Conf.	Prezzo
4670315	24x40	100	6	9,80 €

**TAPPO SUGHERO TIPO
INVECCHIAMENTO**



Cod.	Misura	Pz	Conf.	Prezzo
061125	26x45	100	1	18,20 €

**TAPPO SUGHERO CONICO
TOSCANELLO**



Cod.	mm	Pz	Conf.	Prezzo
004314	21x27	100	1	9,92 €

TAPPO SUGHERO CONICO



Cod.	mm	Pz	Conf.	Prezzo
4670305	21x34	100	2	8,81 €

TAPPO SUGHERO COGNAC

In confezione appendibile.



Cod.	Pz	Conf.	Prezzo
061126	10	10	3,36 €

**TAPPI SUGHERO
PER DAMIGIANA**



Cod.	Ø mm	Conf.	Prezzo
042685	30	25	0,45 €
042686	35	25	0,51 €
042687	40	25	0,56 €
042688	45	25	0,65 €
042689	50	25	0,73 €

**CAPSULA TERMORETRAIBILE
PER BORDOLESI**



FERRARI

Cod.	Ø x H mm	Colore	Conf.	Conf.	Prezzo
4670401	31x55	nero	100	1	5,25 €
4670390	31x55	rosso	100	1	5,37 €
4670400	31x55	oro	100	1	5,26 €
4670405	31x55	verde	100	1	5,26 €
4670406	33x55	oro	100	1	5,05 €
4670408	33x55	verde	100	1	5,05 €

RIEMPITRICE EXTRA

Autolivellante con arresto automatico.



FERRARI

Cod.	Descrizione	Conf.	Prezzo
4670275	a 2 becchi	1	139,00 €

CAMPANA RICAMBIO PER TAPPATRICE CORONA



Cod.	mm	Conf.	Prezzo
002669	26	10	4,20 €
002676	29	10	4,41 €

CALAMITA RICAMBIO PER TAPPATRICE CORONA



Cod.	Descrizione	Conf.	Prezzo
002673	calamita	1	2,21 €

TAPPATRICE CORONA

A colonna.



CORONA

Cod.	Descrizione	Conf.	Prezzo
054786	2 testine Ø 26-29	1	29,00 €

MOLLA RICAMBIO PER TAPPATRICE CORONA



Cod.	Descrizione	Conf.	Prezzo
002674	piccola	1	0,91 €

MOLLA RICAMBIO PER TAPPATRICE CORONA



Cod.	Descrizione	Conf.	Prezzo
002677	grande	1	4,14 €

TAPPATRICE CORONA CREMAGLIERA

2 colonne.



Cod.	Descrizione	Conf.	Prezzo
002675	2 testine Ø 26-29	1	53,70 €

TAPPATRICE 2 LEVE PER TAPPI CORONA

2 boccole.



Risparmio

Cod.	Descrizione	Conf.	Prezzo
4670300	6-29-31	6	12,00 €

TAPPATRICE 2 LEVE PER TAPPI IN SUGHERO

2 boccole.



CORONA

Cod.	Descrizione	Conf.	Prezzo
4670285	leve regolabili	1	18,09 €

**TAPPATRICE A COLONNA
PER TAPPI SUGHERO**



Cod.	Descrizione	Conf.	Prezzo
002671	a colonna	1	104,50 €

**POMPA DA VINO
PER TRAVASO BE-M 20**

Pompa autoaspirante bisenso in ottone.
Portata: 1.700 l/h.
340 W.



Cod.	Ø mm	Hp	rpm	Conf.	Prezzo
054398	20	0.5	2850	1	102,00 €

**POMPA DA VINO
PER TRAVASO BE-M 25**

Pompa autoaspirante bisenso in ottone.
Portata: 2.400 l/h.
420 W.



Cod.	Ø mm	Hp	rpm	Conf.	Prezzo
054399	25	0.6	1450	1	125,00 €

**POMPA DA VINO
PER TRAVASO BE-M 30**

Pompa autoaspirante bisenso in ottone.
Portata: 5.000 l/h.
650 W.



Cod.	Ø mm	Hp	rpm	Conf.	Prezzo
054400	30	1	1450	1	184,50 €

**POMPA DA VINO
PER TRAVASO BE-M 40**

Pompa autoaspirante bisenso in ottone.
Portata: 6.500 l/h.
800 W.



Cod.	Ø mm	Hp	rpm	Conf.	Prezzo
054401	40	1.2	1450	1	313,50 €

**POMPA PER TRAVASO
DRILL 14**

Pompa autoaspirante bisenso in ottone.
Per il corretto funzionamento usare
un trapano che sviluppi almeno 2.000
rpm. Portata: 1.400 l/h.



Cod.	Ø mm	rpm	Conf.	Prezzo
054403	14	2850	1	54,00 €

POMPA UNIVERSALE PER LIQUIDI

Capacità totale 1500 litri/ora.
Pescaggio profondità 2,5 m. Altezza
portata 10 m. Funzionamento a secco
30°.



Cod.	Gambo Ø mm	Tubo	rpm	Conf.	Prezzo
3890	8	1/2"	3400	5	17,85 €

**MOSTIMETRO BABO
TASCABILE**

Misura la percentuale di zucchero
contenuta nel mosto da cui si stima
il grado alcolico finale del vino.



Cod.	Descrizione	Conf.	Prezzo
4670120	con scala graduata	12	6,00 €

VINOMETRO



Cod.	Descrizione	Conf.	Prezzo
4670125	graduato	1	4,12 €

OLIO DI VASELINA



Cod.	lt	Conf.	Prezzo
4670743	1	15	6,30 €
4670744	5	4	31,50 €

KIT DI FERMENTAZIONE MR. MALT

FERRARI

Composto di accessori.



Cod.	Descrizione	Conf.	Prezzo
4670705	kit fermentazione	1	87,80 €

TUBO SPIRALATO ALI-FLEX 25 MT



Cod.	mm	Conf.	Prezzo
GA2260	20	1	48,80 €
GA2261	25	1	58,50 €
GA2262	30	1	76,50 €
GA2263	35	1	93,00 €
GA2264	40	1	116,50 €
GA2265	50	1	163,00 €
GA226555	60	1	209,50 €

BIDONE INOX OLIO MILANO

UNIBRODOLINA



Cod.	lt	Descrizione	Conf.	Prezzo
031486	2	-	1	44,20 €
012488	5	-	1	58,00 €
013965	10	-	1	60,80 €
000641	15	-	1	71,80 €
016883	20	-	1	74,60 €
008878	25	-	1	77,30 €
002749	30	basso	1	82,80 €
009204	50	-	1	89,70 €
015398	50	basso	1	103,50 €

TAPPO BIDONE OLIO MILANO + GUARNIZIONE

UNIBRODOLINA



Cod.	Descrizione	Conf.	Prezzo
040256	tappo - bocca larga	1	25,50 €
040255	tappo - bocca stretta	1	19,50 €
031487	guarnizione - bocca larga	1	3,60 €
031488	guarnizione - bocca stretta	1	2,70 €

BIDONE INOX OLIO

BV



Cod.	lt	Conf.	Prezzo
053740	5	1	84,20 €

BIDONE INOX OLIO

BV



Cod.	lt	Descrizione	Conf.	Prezzo
012486	15	-	1	69,00 €
015197	20	-	1	70,40 €
010168	30	basso	1	73,20 €
011511	50	-	1	75,90 €
019015	100	-	1	135,50 €

TAPPO BIDONE INOX OLIO + GUARNIZIONE

BV



Cod.	Descrizione	Conf.	Prezzo
040254	tappo - bocca larga	1	18,00 €
040253	tappo - bocca stretta	1	16,05 €
000532	guarnizione - bocca larga	1	3,60 €
013966	guarnizione - bocca stretta	1	1,80 €

BIDONE INOX OLIO SALDATO



BV

Cod.	lt	Descrizione	Conf.	Prezzo
053744	30	basso	1	91,40 €
053745	50	-	1	94,90 €

RUBINETTO BIDONE OLIO



Cod.	Descrizione	Conf.	Prezzo
GA8255	3/8"	1	5,85 €
012495	1/2"	1	6,59 €
016753	3/4"	1	12,15 €
019081	1"	1	25,25 €

RUBINETTO BIDONE OLIO INOX



Cod.	Descrizione	Conf.	Prezzo
009205	3/8" - antigoccia	1	15,65 €
008150	1/2" - antigoccia	1	15,65 €

BARATTOLO LATTA RETTANGOLARE CON TAPPO



Cod.	lt	Conf.	Prezzo
059596	0,25	1	1,35 €
059595	0,50	1	1,76 €
031673	1	1	2,20 €
039722	2	1	2,99 €
017207	3	1	3,13 €
016816	5	1	3,30 €
016888	10	1	8,39 €

TAPPO LATTA RETTANGOLARE



Cod.	lt	Conf.	Prezzo
039798	0,25-0,50	100	0,34 €
039797	1-2	100	0,31 €
032960	3-5-10	100	0,37 €

AMPOLLA VETRO SOFFIATO A GOCCIA



Cod.	ml	Conf.	Prezzo
053382	250	6	14,50 €
053383	500	6	18,10 €

AMPOLLA VETRO DA OLIO PAGLIA TUSCIA



Cod.	ml	Descrizione	Conf.	Prezzo
038497	250	paglia tuscia	12	3,39 €
038498	500	paglia tuscia	6	3,92 €
038635	500	brocchetta	6	7,91 €

BOTTIGLIA VETRO DA OLIO MARASCA BIANCA



Cod.	ml	Descrizione	Conf.	Prezzo
038466	100	tappo Ø 24 mm	96	0,51 €
038525	250	tappo Ø 31,5 mm	45	0,46 €
038526	500	tappo Ø 31,5 mm	40	0,71 €
038527	750	tappo Ø 31,5 mm	28	0,75 €
038528	1000	tappo Ø 31,5 mm	24	1,12 €

BOTTIGLIA VETRO DA OLIO MARASCA VERDE



Cod.	ml	Descrizione	Conf.	Prezzo
056936	100	tappo Ø 24 mm	96	0,51 €
038467	250	tappo Ø 31,5 mm	45	0,46 €
038468	500	tappo Ø 31,5 mm	40	0,65 €
038469	750	tappo Ø 31,5 mm	28	0,69 €
038470	1000	tappo Ø 31,5 mm	20	1,09 €

DAMA FONDO PAGLIA



Cod.	lt	Descrizione	Conf.	Prezzo
038917	1	tappo Ø 31,5 mm	12	2,78 €
038675	2	tappo Ø 35 mm	6	4,27 €
038491	3	tappo Ø 31,5 mm	6	3,80 €
038492	5	tappo Ø 35 mm	6	3,96 €

DAMA FONDO PLASTICA



Cod.	lt	Descrizione	Conf.	Prezzo
041688	5	tappo a scatto	1	3,64 €
038493	5	tappo a vite Ø 35	1	3,64 €

TAPPO BOTTIGLIA MARASCA - DAMA



Cod.	Descrizione	Colore	Ø mm	Conf.	Prezzo
038701	plastica con salvagoccia	oro	24	100	0,13 €
038839	metallo con salvagoccia	oro	31,5	100	0,11 €
038499	plastica con salvagoccia	verde	35	100	0,14 €
038665	metallo con salvagoccia	verde	35	100	0,15 €
038664	metallo senza salvagoccia	oro	35	100	0,14 €

TAPPO ANTIRABBOCCO AD INCASTRO MARASCA



Cod.	Colore	Ø mm	Conf.	Prezzo
057108	verde	31,5	1	0,48 €
057109	oro	31,5	1	0,48 €
057109N	nero	31,5	1	0,48 €

AGO PER ACCOPPIAMENTO RETI



Cod.	m	Conf.	Prezzo
028650	4x50	500	27,05 €

RETE OLIVE ANTISPINA PESANTE

90 g/mq.



Cod.	m	Conf.	Prezzo
029690	6x6	1	28,80 €
029691	8x8	1	51,20 €
029692	10x10	1	80,00 €
029693	12x12	1	115,50 €

RETE OLIVE ANTISPINA PESANTE

90 g/mq.



Cod.	m	Conf.	Prezzo
032784	4x50	1	146,00 €
032785	5x50	1	182,50 €
032786	6x50	1	219,00 €
038074	7x50	1	255,50 €
042420	8x50	1	292,00 €

CASSETTA AGRICOLA IMPILABILE APERTA DRITTA



Cod.	cm	Capacità lt	Conf.	Prezzo
029813	55x36x31	40	150	6,56 €

CASSETTA AGRICOLA STANDARD APERTA



Cod.	cm	Capacità lt	Conf.	Prezzo
029812	51x35x31	40	90	7,11 €

SACCO RAFIA BIANCO



Cod.	cm	Conf.	Prezzo
061902	35x50	1000	0,44 €
040834	45x75	1000	0,56 €
040833	55x100	1000	0,59 €

SACCO JUTA

Biodegradabile e riciclabile al 100%, ha una buona resistenza, è molto traspirante e impedisce il passaggio diretto della luce. 420 g/mq.



Cod.	cm	Conf.	Prezzo
062066	40x701	1	2,24 €
062067	56x100	1	4,90 €
062068	70x110	1	4,76 €

RASTRELLO COGLI OLIVA MANICATO



Cod.	cm	Descrizione	Conf.	Prezzo
038473	150	in plastica	5	4,99 €

RASTRELLO RACCOLTA OLIVE



Cod.	Denti	cm	Conf.	Prezzo
GA1080L	9	14	1	0,82 €

MANICATO COGLI OLIVA A RASTRELLO

In plastica. Asta cod. 054731.



Cod.	Descrizione	cm	Conf.	Prezzo
K00077	attrezzo completo	80/150	5	5,35 €

SCOPA LARGA PER FOGLIE E OLIVE

In polipropilene.



Cod.	cm	Conf.	Prezzo
000517	55	1	3,98 €

SCOPA PLASTICA

Da olive.



Cod.	cm	Conf.	Prezzo
000515	39	1	3,63 €

SCOPA PLASTICA DA OLIVE

Manico in legno.



Cod.	Descrizione	cm	Conf.	Prezzo
000515	senza manico	39	1	3,63 €
016294	manicata	39	1	8,10 €

DEFOGLIATRICE ELETTRICO PER OLIVE



Cod.	Potenza W	Conf.	Prezzo
039566	0,35	1	700,00 €

OLIO AGRITECNO FLU

Olio atossico per la lubrificazione degli apparati pneumatici. Antigelo fino a -20°C. Uso professionale in agricoltura.



Cod.	lt	Conf.	Prezzo
063410	1	1	9,04 €

COGLI OLIVA ADRIAN A BATTERIA 12V

Sistema antiblocco, 8 astine in carbonio intercambiabili, asta telescopica. 1400 cicli dinamici al minuto, capacità produttiva 100 kg/h. Il più leggero in commercio.



Cod.	Asta	Peso	Conf.	Prezzo
053326	150/250 cm	1,5 kg	1	588,00 €

SCUOTITORE ULIVI OLYTECH ESSENTIAL

8 astine in fibra di carbonio a sostituzione rapida. Lunghezza rebbi 32 cm. Testa di raccolta inclinata. Movimento pettini alternato con ampiezza di 50 cm. Impugnatura ergonomica. Alimentazione diretta dalla batteria. Asta telescopica di serie da 2,10 - 3,00 m. Dotato di cavo alimentazione da 15 m con pinze e connettori. Produttività: 80-110 kg/h.



Cod.	062040
Motore	12 V cc
Batteria	consigliata 12V - 60/70 Ah
Battute al minuto	950
Peso	2,5 kg
Prezzo	607,00 €

Cod.	Descrizione	Conf.	Prezzo
062057	astina carbonio 455L/555L	1	9,70 €
062060	rinforzo astina carbonio grigio	1	3,42 €



Abbacchiatore per olive a batteria

Dettagli tecnici:

Astine in carbonio intercambiabili;
 Motore elettrico Made in Italy;
 Capacità produttiva 100 kg/h;
 Cicli dinamici al minuto 1400;
 Alimentazione 12 V;
 Peso asta telescopica 650 gr;
 Batteria (non inclusa) 50 A;
 Assorbimento 25 Amp/h;
 Cavo standard 20 mt con morsetti.

Ampiezza di raccolta

Chiuso 30 cm
 Aperto 40 cm

Materiale astine

Carbonio

Asta telescopica

150 - 300 cm

nuovo appoggio per asta



MADE IN ITALY 

TECNOLOGIA E AFFIDABILITÀ AL SERVIZIO DELL'OPERATORE

Gli scuotitori **VOLPI** sono in grado di soddisfare le esigenze sempre più evolute sia del piccolo produttore che del professionista. Vengono progettati e realizzati **interamente in Italia** e offrono la tecnologia più avanzata per la raccolta delle olive. **Potenza, affidabilità e tecnologia al servizio del mondo olivicolo.**



ORIGINALE
VOLPI

QUALITÀ DA OLTRE 140 ANNI

**VASO VETRO BORMIOLI LISCIO
ORTOMANIA**

Completo di coperchio.



Cod.	ml	Ø mm	Conf.	Prezzo
061970	150	70	6	1,04 €
061971	250	70	6	1,10 €
061972	500	70	6	1,18 €
061973	1000	70	6	1,46 €

**CAPSULA VASO HELVETIA
CON FLIP**



Cod.	Descrizione	Ø mm	Conf.	Prezzo
053673	uso sterilizzazione	53	100	0,07 €
054501	uso sterilizzazione	63	100	0,11 €
054502	uso sterilizzazione	70	100	0,14 €
053674	uso sterilizzazione	82	100	0,15 €
054908	uso pastorizzazione	63	100	0,11 €

VASO HELVETIA



Cod.	g	Ø	Conf.	Prezzo
035449	41	43	120	0,25 €
017398	106	53	40	0,26 €
026477	212	63	28	0,30 €
005189	314	63	24	0,32 €
059328	370	63	24	0,38 €
010815	580	82	20	0,50 €
005191	720	82	20	0,53 €
005192	1062	82	12	0,63 €
018218	1700	110	8	1,72 €
018219	3000	110	6	2,52 €

CAPSULA VASO HELVETIA



Cod.	Ø mm	Conf.	Prezzo
013911	38	100	0,08 €
013159	43	100	0,08 €
013131	48	100	0,09 €
004558	53	100	0,06 €
038098	58	100	0,08 €
004559	63	100	0,08 €
038099	66	100	0,10 €
004560	70	100	0,09 €
038100	77	100	0,12 €
004561	82	100	0,10 €
038101	100	100	0,35 €
002989	110	100	0,38 €

VASO ERMETICO BORMIOLI



Cod.	ml	Conf.	Prezzo
008074	500	6	3,05 €
012290	750	6	3,25 €
005196	1000	6	3,45 €
005197	1500	6	3,69 €
012289	2000	6	4,36 €
013716	3000	6	5,64 €
054828	4000	6	6,85 €
042611	5000	6	7,63 €

VASO BORMIOLI FUNGO



Cod.	g	Ø mm	Conf.	Prezzo
005193F	300	70	6	1,12 €
005194F	500	86	6	1,43 €

VASO FIRENZE QUADRO



Cod.	ml	Ø mm	Conf.	Prezzo
053339	212	58	28	0,69 €
059925	314	63	24	0,82 €

VASO BORMIOLI 4 STAGIONI



Cod.	ml	Ø mm	Conf.	Prezzo
025239	150	56	12	0,78 €
005193	250	70	6	1,01 €
005194	500	70	6	1,26 €
0051947	700	86	6	1,35 €
005195	1000	86	6	1,54 €
008075	1500	86	6	2,13 €

CAPSULA VASO BORMIOLI QUATTRO STAGIONI



Cod.	Ø mm	Pz	Conf.	Prezzo
025240	56	3	108	0,38 €
004562	70	2	108	0,44 €
004563	86	2	96	0,67 €

CAPSULA VASO BORMIOLI ORTOMANIA



Cod.	Ø mm	Pz	Conf.	Prezzo
021495	70	1	108	0,30 €
021496	86	1	108	0,56 €

VASO HELVETIA PER MIELE



Cod.	Descrizione	g	Ø mm	Conf.	Prezzo
054907	liscio	390	70	24	0,38 €
033336	cellette	390	70	24	0,38 €
032947	cellette	780	82	20	0,48 €

CAPSULA ALVEARE PER VASO HELVETIA



Cod.	Ø mm	Conf.	Prezzo
036235	70	100	0,09 €
032948	82	100	0,10 €

VASO VETRO ORTES

Con tappo a vite rosso.



Cod.	g	Conf.	Prezzo
042341	1000	12	2,75 €
042297	2500	6	5,38 €
042298	3500	6	6,80 €
042299	5000	6	7,18 €

BOTTIGLIA VETRO PER PASSATA



Cod.	g	Ø mm	Conf.	Prezzo
023642	446	53	20	0,44 €
023644	720	53	20	0,47 €

PRESSINO PER VASI VETRO

Cod. 040282 e 040283 sono blister da 10 pezzi.



Cod.	Ø mm	Conf.	Prezzo
040282	50	10	1,96 €
040283	70	10	2,76 €
056690	105	10	0,34 €
056691	150	10	0,68 €
056692	180	10	0,88 €

GUARNIZIONE PER TAPPI VASO



FERRARI

Cod.	Pz	Conf.	Prezzo
4670395	10	10	0,27 €

COLA POMODORO

Il "Colapomodoro" è un utile accessorio per ergere da un recipiente il pomodoro o qualsiasi altro alimento. In alluminio per alimenti.



Cod.	Dimensioni imballo	Conf.	Prezzo
012276	30x83x25	20	10,15 €

IMBUTO PER CONSERVE BIANCO

In plastica.



Cod.	Ø cm	Conf.	Prezzo
040284	18	6	2,60 €

RIEMPIBOTTIGLIE FUNNY



Cod.	lt	Conf.	Prezzo
059372	16	12	10,15 €

FORNELLONE GAS 4 ZAMPE

In ghisa.

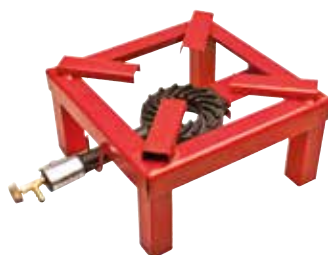

Cod.	cm	Conf.	Prezzo
GA1131	30x30	2	28,70 €
GA1130	40x40	2	30,70 €

FORNELLONE GAS 4 PIEDI

Fornello in ghisa. Accensione piezoelettrica e dispositivo di sicurezza.



Cod.	cm	Conf.	Prezzo
063693	40x40	1	57,70 €

PENTOLA CALDAIA PESANTE E COPERCHIO

In alluminio.



Cod.	Ø cm	Conf.	Prezzo
Coperchio			
003321	24	1	2,90 €
003322	26	1	3,00 €
003323	28	1	3,13 €
003324	30	1	3,48 €
003325	32	1	3,91 €
003326	34	1	4,04 €
004102	36	1	4,29 €
003328	38	1	4,52 €
003329	40	1	4,87 €
003330	42	1	5,25 €
003331	44	1	6,18 €
040467	46	1	6,43 €
003333	48	1	7,06 €
009264	52	1	8,65 €
003335	56	1	9,56 €
003336	60	1	10,85 €
003337	64	1	12,25 €
Pentola			
009265	24	1	4,64 €
009266	26	1	5,02 €
009267	28	1	5,42 €
009268	30	1	6,10 €
009269	32	1	6,76 €
009270	34	1	7,69 €
009271	36	1	9,28 €
009272	38	1	9,96 €
009273	40	1	10,75 €
009274	42	1	14,90 €
012271	44	1	16,40 €
040466	46	1	18,90 €
042578	48	1	24,95 €
042568	52	1	29,00 €
042569	56	1	33,30 €
042570	60	1	39,40 €
042571	64	1	48,70 €

SPREMIPOMODORO ELETTRICO SKUIZZI



Macchina per la trasformazione del pomodoro "in passata" studiata ergonomicamente per un facile uso e una buona pulizia. Corpo macchina e ghiera in alluminio pressofuso brillantato per alimenti.



Cod.	Descrizione	Conf.	Prezzo
052326	900 W	1	130,50 €

**SPREMIPOMODORO ELETTRICO
INOX SPREMITO**

Corpo ed elica in ghisa stagnata.
Tramoggia e collettore in acciaio inox.
Filtro in acciaio inox. Potenza motore
300 W.



Cod.	Descrizione	Conf.	Prezzo
059368	N.3	1	250,00 €

**SPREMIPOMODORO ELETTRICO
MED-JUNIOR**

Corpo ed elica in ghisa stagnata.
Tramoggia e collettore in acciaio inox.
Filtro in acciaio inox. Potenza motore
300 W.



Cod.	Descrizione	Conf.	Prezzo
059369	inox - N.4	1	274,00 €

**SPREMIPOMODORO
ELETTRICO SM5**

Macchina per la trasformazione del
pomodoro "in passata" studiata
ergonomicamente per un facile
uso e una buona pulizia. Corpo
macchina ghiera e carter in
alluminio UNI 50 pressofuso
brillantato per alimenti.



Cod.	Descrizione	Conf.	Prezzo
052328	SM5 inox 0,5 HP	1	255,00 €

**SPREMIPOMODORO
ELETTRICO SM3**

Macchina per la trasformazione del
pomodoro "in passata" studiata
ergonomicamente per un facile
uso e una buona pulizia. Corpo
macchina ghiera e carter in
alluminio UNI 50 pressofuso
brillantato per alimenti.



Cod.	Descrizione	Conf.	Prezzo
052327	SM3 inox 0,5 HP	1	206,50 €

**SPREMIPOMODORO ELETTRICO
CON BANCO**

Macchina per la trasformazione del
pomodoro "in passata" studiata
ergonomicamente per un facile
uso e una buona pulizia. Corpo
macchina e ghiera in alluminio
UNI 50 pressofuso brillantato per
alimenti.



Cod.	Descrizione	Conf.	Prezzo
052325	TS PLAST 0,45 HP	1	243,50 €

SPREMIPOMODORO MANUALE



Cod.	Descrizione	Conf.	Prezzo
059370	N. 2	1	69,20 €
059371	N. 3	1	84,50 €

**ACCESSORIO TRITACARNE
PER SPREMITO E JUNIOR**

Composto da tritacarne, elica e ghiera
in ghisa, tramoggia in plastica, pestello
in plastica, piastra inox Ø foto 6 mm e
coltello inox.



Cod.	Descrizione	Conf.	Prezzo
059753	N. 8	1	116,50 €

ACCESSORIO TRITACARNE



Cod.	Descrizione	Conf.	Prezzo
052943	N. 12	1	136,50 €

RICAMBI SPREMIPOMODORO ELETTRICO



Cod.	Descrizione	Modello	Conf.	Prezzo
052333	filtro inox	n° 3	1	30,50 €
052335	imbuto inox	n° 3	1	34,00 €
052340	pernio	n° 3	1	12,20 €
052334	filtro inox	n° 5	1	29,00 €
052336	imbuto inox	n° 5	1	40,60 €

PASSATUTTO EMANUEL

Passatutto in acciaio inox con tre filtri intercambiabili e tre piedini pieghevoli.



Cod.	Misura	Ø cm	Conf.	Prezzo
032829	n.2	22	1	16,60 €
032830	n.3	32	1	21,85 €

SPREMIPOMODORO MANUALE

GULLIVER

Sprempomodoro in acciaio inox con guarnizione salvatavolo in plastica e morsetto per il fissaggio.



Cod.	cm	Conf.	Prezzo
008106	17x22,5x30	12	32,20 €

PASSATUTTO PLASTICA

TILLY

Passatutto in plastica a 3 dischi, con particolari in acciaio inox.



Cod.	Misura	Ø cm	Conf.	Prezzo
054285	n.2	20	1	8,29 €
054286	n.3	24	1	10,25 €

SPREMIPOMODORO MANUALE

VELOX

Con corpo in polipropilene, rullo a manovella in poliammide e retina in acciaio inox. Ventosa in gomma caucciù e con movimenti del gruppo ventosa in poliammide, completamente e facilmente smontabile per un'accurata pulizia.



Cod.	cm	g	Conf.	Prezzo
004380	22,5x19x25,5	980	1	24,65 €

SCHIACCIAPATATE INOX QUICK



Cod.	Ø fori	Conf.	Prezzo
054287	2,5 mm	1	14,95 €

SPREMIPOMODORO MANUALE

MASTER

Con corpo in polipropilene, rullo a manovella in poliammide e retina in acciaio inox. Ventosa in gomma caucciù e con movimenti del gruppo ventosa in poliammide, completamente e facilmente smontabile per un'accurata pulizia.



Cod.	cm	g	Conf.	Prezzo
004381	24x20x31,5	1180	1	29,90 €

PASSACOLINO INOX

Ideale per setacciare finemente frutta, verdura, pomodori, legumi e altro.



Cod.	Ø cm	Conf.	Prezzo
054288	20	1	21,90 €

TRITACARNE GHISA MANUALE



Cod.	Descrizione	Conf.	Prezzo
031739	N° 5	1	28,75 €
029766	N° 8	1	35,00 €
032509	N° 10	1	42,70 €

TRITACARNE GHISA MANUALE



Cod.	Descrizione	Conf.	Prezzo
036008	N° 12	1	47,70 €
036009	N° 22	1	74,10 €

TRITACARNE ELETTRICO



Cod.	Descrizione	Conf.	Prezzo
052329	SM12 inox 0,5 HP	1	281,50 €
052330	SM22 inox 1 HP	1	436,50 €

TRITATUTTO IN PLASTICA

In polipropilene con dischi in acciaio carbonitrurato e rettificati. Ventosa in gomma caucciù e movimenti del gruppo ventosa in poliammide 66. Articolo facilmente smontabile per un'accurata pulizia. Lavabile in lavastoviglie.



Cod.	Descrizione	Conf.	Prezzo
004645	art. 120	24	14,60 €

TRITACARNE PLASTICA

In polipropilene per uso alimentare. Dischi carne in acciaio carbonitrurato e rettificati. Coltello in acciaio inox temperato e rettificato. Ventosa in gomma caucciù. Movimenti del gruppo ventosa in poliammide 66. Facilmente smontabile per una accurata pulizia. Lavabile in lavastoviglie.



Cod.	Descrizione	Conf.	Prezzo
004644	art. 125	1	14,60 €

ELICA GHISA TRITACARNE



Cod.	Descrizione	Conf.	Prezzo
064007	n. 22	1	120,00 €
064008	n. 32	1	60,00 €
064009	32 EL - 1,5 hp	1	120,00 €

CUSCINETTO ELICA TRITACARNE



Cod.	Descrizione	Conf.	Prezzo
064004	32EL - 1,5 hp	1	4,96 €

IMBUTO PL TRITACARNE



Cod.	Descrizione	Ø foro	Conf.	Prezzo
064010	n. 22	10 mm	1	3,90 €
064011	n. 22	20 mm	1	3,90 €
064012	n. 22	30 mm	1	3,90 €
064013	n.32	10 mm	1	3,90 €
064014	n.32	20 mm	1	3,90 €
064015	n.32	30 mm	1	3,90 €

MANOVELLA TRITACARNE



Cod.	Descrizione	Conf.	Prezzo
064016	n. 22	1	19,50 €
064017	n. 32	1	24,00 €

PERNO ELICA TRITACARNE



Cod.	Descrizione	Conf.	Prezzo
063740	n. 22	1	11,25 €
063741	n.32	1	9,00 €

PESTELLA TRITACARNE



Cod.	Descrizione	Conf.	Prezzo
059410	plastica	1	5,70 €

VITE MANOVELLA TRITACARNE



Cod.	Descrizione	Conf.	Prezzo
036017	n. 5	1	43,80 €
063742	n. 12/22/32	1	3,00 €

PIASTRA TRITACARNE INOX

Con mozzo.



Cod.	Descrizione	Ø foro	Conf.	Prezzo
004626	n. 22	4,5 cm	1	26,45 €
004621	n. 22	6 cm	1	26,45 €
037228	n. 22	8 cm	1	26,45 €
037229	n. 22	10 cm	1	26,45 €
037230	n. 22	12 cm	1	26,45 €
037251	n. 22	14 cm	1	26,45 €
004622	n.32	6 cm	1	41,10 €
037232	n.32	8 cm	1	41,10 €
061295	n.32	10 cm	1	41,10 €
061296	n.32	12 cm	1	41,10 €
061297	n.32	14 cm	1	41,10 €

PIASTRA TRITACARNE INOX

Senza mozzo.



Cod.	Descrizione	Ø foro	Conf.	Prezzo
004623	n. 5	4,5 cm	1	12,20 €
032510	n. 5	6 cm	1	12,20 €
032511	n. 5	8 cm	1	12,20 €
054105	n. 5	10 cm	1	12,20 €
054106	n. 5	12 cm	1	12,20 €
004624	n. 8	4,5 cm	1	19,05 €
004619	n. 8	6 cm	1	19,05 €
037223	n. 8	8 cm	1	19,05 €
037224	n. 8	10 cm	1	19,05 €
037225	n. 8	12 cm	1	19,05 €
037227	n. 10/12	8 cm	1	25,10 €
035817	n. 10/12	10 cm	1	25,10 €
035818	n. 10/12	12 cm	1	25,10 €

PIASTRA TRITACARNE INOX

Foro 0.



Cod.	Descrizione	Conf.	Prezzo
062329	n. 22	1	26,45 €
062328	n. 32	1	41,10 €

COLTELLO TRITACARNE MANUALE INOX



Cod.	Descrizione	Conf.	Prezzo
039200	n. 5	1	6,70 €
004630	n. 8	1	8,01 €
035819	n. 10/12	1	9,66 €
004633	n. 22	1	11,75 €
004634	n.32	1	15,15 €

INSACCATRICE MANUALE INOX



Cod.	Kg	Conf.	Prezzo
052331	5	1	217,50 €
052332	8	1	232,00 €

INSACCATRICE MANUALE MOD.10

Cilindro inox dalla capacità di 10 lt. Cremagliera in acciaio al carbonio. Realizzata con materiali che garantiscono una lunga durata nel tempo. Con doppia velocità del pistone per un carico più veloce.



Cod.	kg	Conf.	Prezzo
063719	20	1	493,00 €

GANCIO DA MACELLAIO

In acciaio inox.



Cod.	mm	Conf.	Prezzo
010585	80x4	10	0,68 €
001750	100x4	10	0,71 €
001751	120x5	10	0,95 €
001752	140x5	10	0,98 €
001753	160x6	10	1,22 €
001756	180x8	10	2,46 €
001757	200x8	10	2,97 €

PUNGISALAME



Cod.	Descrizione	Conf.	Prezzo
007543	impugnatura in plastica	10	11,00 €

AFFILACOLTELLI INOX



Cod.	Descrizione	Conf.	Prezzo
000154	art. 1	120	6,19 €

APRISCATOLA PROFESSIONAL



Cod.	Descrizione	Conf.	Prezzo
005525	art. 6	1	8,74 €

APRISCATOLA FARFALLA FAMILY

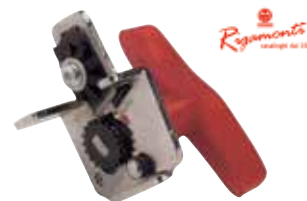

Cod.	Descrizione	Conf.	Prezzo
000031	art. 5	120	6,11 €

APRISCATOLA FARFALLA RAPID INOX



Cod.	Descrizione	Conf.	Prezzo
000030	art. 10	100	6,33 €

STACCIO DA FARINA IN RETE



Cod.	Maglia	Ø cm	Conf.	Prezzo
063199	24	20	1	14,85 €
063200	24	28	1	20,70 €
063201	30	20	1	15,00 €
063202	30	28	1	21,35 €

STACCIO DA GRANO



Cod.	Descrizione	Ø cm	Conf.	Prezzo
063665	per grano	40	1	35,10 €
063665	per fagioli	40	1	35,10 €

SPAGO CANDIDO



Cod.	Misura	g	Pz	Conf.	Prezzo
000765	2/4	100	10	1	22,10 €

SPAGO PPL BIANCO



Cod.	m	kg	Pz	Conf.	Prezzo
040334	370	2	12	1	77,60 €
000810	500	2	12	1	77,60 €
040591	1200	2	6	1	77,60 €

SPAGO GREZZO



Cod.	Misura	g	Pz	Conf.	Prezzo
000772	2/1	100	10	1	12,30 €
000768	2/2	100	10	1	13,80 €
053902	2/3	100	10	1	15,50 €
000767	2/3,4	100	10	1	9,11 €
000766	2/4	100	10	1	15,90 €
013833	2/6	100	10	1	16,60 €
023304	2/10	100	10	1	27,05 €

MACCHINA SOTTOVUOTO WENDY

Compatta, pratica e semplicissima da usare. Pannello di comando digitale con LED luminoso. Camera del vuoto con taglio di sicurezza a 45°. In dotazione: 10 buste goffrate 20x30 cm.



Cod.	W	Portata aria	Conf.	Prezzo
062904	42	12 l/min	1	143,00 €

SPAGO GREZZO 500 G



Cod.	Misura	g	Pz	Conf.	Prezzo
028561	2/1	500	6	1	33,20 €
000770	2/2	500	6	1	38,70 €
000769	2/3,4	500	6	1	25,15 €
013834	2/4	500	6	1	33,20 €

MACCHINA SOTTOVUOTO ELITE 300 PLUS

Ultracompatta, semplice e automatica, con parte inferiore staccabile e lavabile anche in lavastoviglie - brevettata, made in Italy, completa di 50 sacchetti per sottovuoto rigati 20x30 cm.



Cod.	W	Conf.	Prezzo
PN00435	170	6	152,00 €

SSPAGO PPL BIANCO GOMITOLO



Cod.	m	g	Conf.	Prezzo
041415	500	300	12	3,63 €

MACCHINA SOTTOVUOTO COMPACT MV KIT

Macchina sottovuoto potente e ultracompatta con taglia-sacchetti bidirezionale integrato. Comodo oblio per un corretto posizionamento del sacchetto. Ciclo per la creazione del vuoto nei contenitori. Barra saldante: 30 cm. Sacchetti in omaggio.



Cod.	Descrizione	Conf.	Prezzo
063070	230 V - 50 Hz	1	97,70 €

CONTENITORE SOTTOVUOTO



Cod.	Portata lt	Conf.	Prezzo
GA8560	1	1	25,28 €
GA8570	1,5	1	25,28 €

SACCHETTI PER SOTTOVUOTO PRETAGLIATI E ROTOLI



Cod.	Descrizione	cm	Pz	Conf.	Prezzo
BS1525P	sacchetti	15x25	50	1	4,38 €
BS1530	sacchetti	15x30	100	1	10,30 €
BS2030	sacchetti	20x30	100	1	13,75 €
BS2535P	sacchetti	25x35	50	1	10,25 €
BS3040	sacchetti	30x40	100	1	27,55 €
BR1506	rotoli	15x600	4	1	25,50 €
BR3006	rotoli	30x600	2	1	23,75 €

FORBICE MULTIUSO

Impugnatura in fibra di vetro.



Cod.	Descrizione	Conf.	Prezzo
FU-29405	multiuso	1	11,20 €

FORBICE DA CUCINA IN TITANIO

Manico in gomma.



Cod.	Lama	Conf.	Prezzo
FU-29401	5,5"	12	2,80 €

FORBICI PER CUCINA

Lama al titanio con manico gommato antiscivolo.



Cod.	Lama	Conf.	Prezzo
FU-29402	7,50"	1	3,30 €
FU-29403	8,50"	1	3,50 €
FU-29404	9,75"	1	3,70 €

FORBICE DA CUCINA IN TITANIO



Betakut

Cod.	Descrizione	Conf.	Prezzo
040663	5"	6	3,95 €

FORBICE DA CUCINA IN TITANIO



Betakut

Cod.	Descrizione	Conf.	Prezzo
040664	7"	6	5,41 €

FORBICE DA CUCINA IN TITANIO



Betakut

Cod.	Descrizione	Conf.	Prezzo
040665	8"	6	6,21 €

ESPOSITORE FORBICE DA CUCINA IN TITANIO

6 forbici 5" (040663)
6 forbici 7" (040664)
6 forbici 8" (040665)



Betakut

Cod.	Pz	Conf.	Prezzo
042301	18	10	87,60 €

FORBICE LAVORO



Cod.	Descrizione	Conf.	Prezzo
010264	5"	12	8,31 €
010265	6"	12	9,64 €
010266	7"	12	11,00 €

FORBICE SARTO



Cod.	Descrizione	Conf.	Prezzo
006432	8"	12	15,70 €

FORBICE SARTINA



Cod.	Descrizione	Conf.	Prezzo
009146	7"	12	11,65 €

FORBICE RICAMO



Cod.	Descrizione	Conf.	Prezzo
012442	3" 1/2	12	7,23 €

FORBICE MANICURE



Cod.	Descrizione	Conf.	Prezzo
012440	3" 1/2 - curva	12	6,51 €
013158	4" - curva	12	6,99 €

TAGLIAUNGHIA



Cod.	Descrizione	Conf.	Prezzo
004831	piccolo	12	1,21 €
017050	grande	12	2,05 €

ESPOSITORE RICARICA GAS BUTANO RN13

Qualità universale. Ricarica da 18 ml.



Cod.	Descrizione	Conf.	Prezzo
3760050	qualità universale	25	0,90 €

ESPOSITORE RICARICA GAS BUTANO R14

Ricarica alta qualità. In bomboletta metallo da 19 ml.



Cod.	Descrizione	Conf.	Prezzo
3760055	alta qualità	24	1,74 €

ACCENDIGAS VIVI MINI BBQ

5 colori assortiti.



Cod.	Descrizione	Conf.	Prezzo
063145	ricaricabile	25	21,75 €

ACCENDINO ELETTRICO DOPPIA FIAMMA

5 colori metallici assortiti. Design con elementi in gomma.



Cod.	Descrizione	Conf.	Prezzo
063150	ricaricabile	25	66,00 €

ACCENDIGAS GINA BBQ

4 colori assortiti.



Cod.	Descrizione	Conf.	Prezzo
063146	ricaricabile	12	20,90 €

ACCENDIGAS MARIO BBQ

4 colori assortiti.
Canna flessibile.



Cod.	Descrizione	Conf.	Prezzo
063148	ricaricabile	20	30,60 €

ACCENDINO ELETTRICO DOPPIA FIAMMA

5 colori assortiti. Semitrasparenti. Design con elementi in gomma.



Cod.	Descrizione	Conf.	Prezzo
063151	ricaricabile	25	66,00 €

ACCENDINO ELETTRICO TURBO FIAMMA ROSSA

5 colori assortiti. Design con elementi in gomma.



Cod.	Descrizione	Conf.	Prezzo
063149	ricaricabile	50	40,50 €

ACCENDIGAS JORDAN BBQ

4 colori assortiti.



Cod.	Descrizione	Conf.	Prezzo
063147	ricaricabile	16	20,65 €

RIDUTTORE PER FORNELLI



Cod.	Descrizione	Conf.	Prezzo
841205	per fornelli piccoli	10	0,62 €
841206	per fornelli grandi	10	1,36 €

ACCENDINO ELETTRICO DOPPIA FIAMMA

5 colori mimetici assortiti. Design con elementi in gomma.



Cod.	Descrizione	Conf.	Prezzo
063152	ricaricabile	25	66,00 €

RETINA SPARGIFIAMMA



Cod.	Ø cm	Conf.	Prezzo
028179	17	10	1,63 €
028180	20	10	1,91 €

GRATICOLA DA PANE



Cod.	Descrizione	cm	Conf.	Prezzo
001808	in acciaio inox	25x25	25	9,25 €

DISPENSER OLIO ED ACETO OLITO

Scomparti olio e aceto separati. Dosatore manuale a pressione.



Cod.	Descrizione	Conf.	Prezzo
PN00491	2 scomparti	1	12,90 €

PORTASPEZIE A TORRE SPEZIO

Fornito senza spezie. Sei scomparti separati. Regolazione della dimensione del macinato.



Cod.	Descrizione	Conf.	Prezzo
PN00492	6 scomparti	1	15,75 €

MACINALE SPICE 16

Corpo in metracrilato trasparente e brillante. Equipaggiato con macine coniche in ceramica.



Cod.	H cm	g	Conf.	Prezzo
062906	16	280	1	37,60 €

MACINAPEPE SPICE 16

Macine coniche in acciaio temprato per una perfetta regolazione e precisione di macinatura. Corpo in metracrilato trasparente e brillante.



Cod.	H cm	g	Conf.	Prezzo
062905	16	280	1	37,60 €

MACINAPEPERONCINO FINITURA ROSSO

Realizzato in pregiato legno di faggio a lunga stagionatura. Macine coniche giganti in acciaio temprato. Protezione superficiale antiruggine delle macine. Dentature di precisione.



Cod.	H cm	g	Conf.	Prezzo
062907	13	320	1	47,10 €

MACINAPEPE COL 15

Corpo in pregiato legno di faggio stagionato. Macine coniche in acciaio temprato. Protezione superficiale antiruggine delle macine. Dentature di precisione.



Cod.	H cm	g	Conf.	Prezzo
062908	15	250	1	39,70 €

MACINAPEPE COL 21

Corpo in pregiato legno di faggio stagionato. Macine coniche in acciaio temprato. Protezione superficiale antiruggine delle macine. Dentature di precisione.



Cod.	H cm	g	Conf.	Prezzo
062909	21	300	1	42,60 €

CARAMELIZZATORE PROFESSIONALE TORCH CAI

Apparecchio in alluminio a fiamma affidabile e durevole. Uscita della fiamma regolabile per un uso controllato. Caratteristiche di sicurezza approvate da TÜV. Valvola del gas di grado superiore per ricaricare in modo sicuro.



Cod.	Temperatura fiamma	Conf.	Prezzo
3760020	1.300 °C / 2.340 °F	12	20,70 €

FORNELLO A GAS MINERVA

Base in alluminio con piedini in plastica, griglia removibile, regolazione della fiamma, funzionamento a gpl, solo per utilizzo esterno, colore bianco.



Cod.	Descrizione	Conf.	Prezzo
PN01095	2 fuochi	4	40,50 €
PN01094	3 fuochi	4	46,30 €

FORNELLO 3 FUOCHI GAS

Smaltato bianco, con coperchio, bruciatori in lega Pyral N2, spartifiamma in ottone stampato, griglia in acciaio cromato. Dimensioni: 71 x 32 x 14,5 cm. Peso: kg. 6,1



Cod.	Descrizione	Conf.	Prezzo
158538	GPL	1	123,00 €
158540	metano	1	123,00 €

FORNELLO 1 FUOCO GAS

Smaltato bianco, con coperchio, bruciatori in lega Pyral N2, spartifiamma in ottone stampato, griglia in acciaio cromato. Dimensioni: cm 29 x 29 cm. Peso: 2,3 kg.



Cod.	Descrizione	Conf.	Prezzo
158532	GPL	1	59,00 €
158533	metano	1	59,00 €

FORNO ELETTRICO DIABLO

Con girarrosto e luce interna. Timer 60 minuti.



Cod.	W	cm	Conf.	Prezzo
PN01079	800	38x21x27	1	46,00 €

FORNELLO 2 FUOCHI GAS

Smaltato bianco, con coperchio, bruciatori in lega Pyral N2, spartifiamma in ottone stampato, griglia in acciaio cromato. Dimensioni: cm 48 x 29 x 12 cm. Peso: 3,4 kg.



Cod.	Descrizione	Conf.	Prezzo
158534	GPL	1	74,80 €
158536	metano	1	74,80 €

BOLLITORE ELETTRICO VINTAGE 2200 W

Capacità 1,8 lt. Controllo di sicurezza STRIX. Filtro anticalcare removibile e lavabile. Funzione autospegnimento all'ebollizione dell'acqua.



Cod.	lt	Conf.	Prezzo
PN00493	1,8	1	52,00 €

FORNELLO 3 FUOCHI GAS

Smaltato bianco, con coperchio, bruciatori in lega Pyral N2, spartifiamma in ottone stampato, griglia in acciaio cromato. Dimensioni: cm 58,5 x 27,5 x 12,5 cm. Peso: 4,2 kg.



Cod.	Descrizione	Conf.	Prezzo
158542	GPL	1	93,70 €
158544	metano	1	93,70 €

SPREMIAGRUMI ELETTRICO

Spremitura regolabile a pressione. Doppio senso di rotazione. Vano avvolgicavo. Due coni in dotazione. Filtro antipolpa.



Cod.	W	lt	Conf.	Prezzo
PN01046	25	0,5	1	18,00 €

BOLLITORE ELETTRICO

Indicatore del livello dell'acqua. Spegnimento automatico ebollizione. Strix controller. Indicatore luminoso funzionamento.



Cod.	lt	Conf.	Prezzo
PN01257	1,7	6	24,55 €

BILANCIA PESA PERSONA ELETTRONICA

Display LCD. Graduazione 0,1 Kg, 4 sensori ad alta precisione, piatto in vetro, accensione e spegnimento automatico, indicatore di sovraccarico, indicatore batteria scarica.



Cod.	Portata max kg	Conf.	Prezzo
PN01112	180	1	22,80 €

BILANCIA PESA PERSONA DIGITALE

Graduazione 0,1 kg. Display LCD. Sensori ad alta precisione. Elegante rivestimento effetto pelle. Accensione e spegnimento automatico. Indicatore di sovraccarico. Indicatore batteria scarica. Batterie 2XAAA.



Cod.	Portata kg	Conf.	Prezzo
PN01259	180	6	26,60 €

ASCIUGACAPELLI PROFESSIONALE

2 velocità. 3 livelli di temperatura. Tecnologia a ioni negativi con griglia ceramica. Filtro magnetico per agevolare la pulizia. Concentratore e diffusore. Occhietto per aggancio phon.



Cod.	W	Conf.	Prezzo
PN01258	2000	8	31,40 €

ASCIUGACAPELLI DA VIAGGIO HAND STYLE



Doppia alimentazione 115/230 V 50/60Hz, motore DC, manico pieghevole, 2 posizioni di temperatura. Autospegnimento di sicurezza.



Cod.	W	Colore	Conf.	Prezzo
PN01311	1200	bianco	6	13,00 €

BILANCIA A MOLLA



Cod.	Kg	Conf.	Prezzo
FU-8711	12	1	7,46 €

SACCO ASPIRAPOLVERE

Sachetto di carta ad alta filtrazione.



Cod.	Descrizione	Pz	Conf.	Prezzo
PN00523	per PN00520	5	1	13,55 €

ASPIRAPOLVERE CON SACCO ZANUSSI

Con indicatore sacco pieno. Maniglia da trasporto comoda ed ergonomica. Spazzola combinata DustPro per tappeti e pavimenti duri. Spazzola Mini Turbo per la pulizia profonda di imbottiti. Accessorio bocchetta per fessure e pennello per mobili 2 in 1, bocchetta per imbottiti. Tubo in alluminio telescopico. Impugnatura standard.



Cod.	PN00520
Potenza	600 W
Classe	A
Colore	rosa metallico
Peso	3,7 Kg
Prezzo	104,50 €

DEUMIDIFICATORE COMPATTO TD-C1410 **TÖYÖTÖMI**

Con compressore e ionizzatore incluso.
Rumorosità max 46 DB. Consumo max
0,205 Kw. Con due velocità di ventola.



Cod.	lt	Conf.	Prezzo
059599	10	1	222,50 €

CLIMATIZZATORE PORTATILE BIANCO **TÖYÖTÖMI**

2,05 kW.



Cod.	Descrizione	Conf.	Prezzo
056829	320x290x260 m3/h	1	474,00 €

VENTILATORE A TORRE **AXEL**



Cod.	Descrizione	cm	Conf.	Prezzo
FU-8162	3 velocità	73	1	35,50 €

VENTILATORE A PIANTANA BIANCO **AXEL**

Base a croce.



Cod.	Ø cm	Conf.	Prezzo
FU-8167	40	1	27,30 €

VENTILATORE A PIANTANA 3 IN 1 **AXEL**

Base tonda.



Cod.	Ø cm	Conf.	Prezzo
FU-8168	46	1	48,90 €

PALETTA ABBATTIMOSCHE

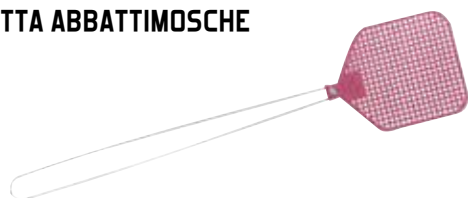

Cod.	Descrizione	Conf.	Prezzo
007077	manico in ferro	25	0,52 €

PINZA RACCOGLI TUTTO



Cod.	cm	Conf.	Prezzo
054739	100	1	19,55 €

SCOPA TRADIZIONALE SABRINA



Cod.	Descrizione	Conf.	Prezzo
054720	fibre semirigide	1	3,21 €

SCOPA EUROPA



Cod.	Descrizione	Conf.	Prezzo
008528	senza manico	12	1,74 €

SCOPA TRADIZIONALE HELENE



Cod.	Descrizione	Conf.	Prezzo
054721	fibre micropiumate	1	4,12 €

SCOPA SALVARREDI LORENA



Cod.	Descrizione	Conf.	Prezzo
054723	gommino salvarredi	1	5,97 €

SCOPA CATTURAPOLVERE CRISTINA



Cod.	Descrizione	Conf.	Prezzo
054722	attacco universale	6	5,92 €

SCOPA DA CORTILE PULITO & NATURA



Cod.	Descrizione	Conf.	Prezzo
054725	in legno	6	5,68 €

SCOPINO PER BAMBINI



Cod.	Descrizione	Conf.	Prezzo
054734	sintetico	25	1,87 €

SCOPA PAVIMENTI AGILE CON PALETTA PER INTERNI.



Cod.	cm	Conf.	Prezzo
063593	35x10x131	6	10,65 €

SCOPA SALVARREDI MAGIA



Cod.	Descrizione	Conf.	Prezzo
054724	con manico allungabile	12	8,24 €

SCOPA VILEDA 2 IN 1

Per rimuovere ogni tipo di sporco, la polvere ed i capelli in una sola passata senza sollevarli.



Cod.	Descrizione	Conf.	Prezzo
PN00136	con paracolpi	1	

SCOPA ERCOLE ESTENSIBILE



Cod.	Descrizione	Conf.	Prezzo
030121	manico in alluminio	12	12,80 €

SCOPETTINA FOCOLARE BIMBO

Made in Italy.



Cod.	Descrizione	Conf.	Prezzo
000310	manico lungo	10	4,40 €

SPAZZOLINO SAGGINA

Made in Italy.



Cod.	Descrizione	Conf.	Prezzo
004483	tondo	10	

SCOPINO SAGGINA AUTO

Manico corto.
Made in Italy.



Cod.	Descrizione	Conf.	Prezzo
023078	manico in legno	10	3,80 €

SCOPA SAGGINA 4 FILI

Made in Italy.



Cod.	Descrizione	Conf.	Prezzo
008558	con manico	20	8,96 €

SCOPA INDUSTRIALE NERA



Cod.	Descrizione	Conf.	Prezzo
054726	piumata pvc	10	2,56 €

SCOPA INDUSTRIALE



Cod.	Descrizione	Conf.	Prezzo
007560	nera	12	1,80 €

MANICATO SCOPA INDUSTRIALE



Cod.	Descrizione	Conf.	Prezzo
016353	scopa industriale	1	2,89 €

SCOPETTONE INDUSTRIALE IN LEGNO



Cod.	cm	Conf.	Prezzo
007561	60	6	6,18 €
008570	80	6	7,81 €

SPAZZETTONE SAN FRANCESCO

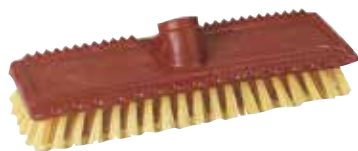

Cod.	Descrizione	Conf.	Prezzo
011776	in plastica	12	1,62 €

SPAZZETTONE PAVIMENTO RECORD



Cod.	Descrizione	Conf.	Prezzo
054728	puntonato	24	2,11 €

SPAZZETTONE PAVIMENTO KOLOSSAL



Cod.	Descrizione	Conf.	Prezzo
054729	in plastica	24	2,35 €

PORTASCOPE 1 POSTO LUX



Cod.	Varie	Conf.	Prezzo
841200	1 posto	30	2,14 €

PORTASCOPE 3 POSTI LUX



Cod.	Varie	Conf.	Prezzo
841201	3 posto	6	7,13 €

GANCIO APPENDISCOPA A 1 POSTO

Prodotto interamente in acciaio inossidabile satinato per garantire durata nel tempo. La particolare forma è stata studiata per offrire praticità d'uso e sicurezza di tenuta.



Cod.	Descrizione	Conf.	Prezzo
063254	senza biadesivo	50	0,90 €
063255	con biadesivo	50	1,28 €

GANCIO APPENDISCOPA A 2 POSTI

Prodotto interamente in acciaio inossidabile satinato per garantire durata nel tempo. La particolare forma è stata studiata per offrire praticità d'uso e sicurezza di tenuta.



Cod.	Descrizione	Conf.	Prezzo
063256	con biadesivo	50	7,95 €

MANICO SCOPA METALLO



Cod.	Descrizione	Conf.	Prezzo
004490	in metallo - 120 cm	25	0,62 €

MANICO SCOPA



Cod.	mm	Descrizione	Conf.	Prezzo
GA7608	1500	in legno verniciato	25	2,38 €

MANICO SCOPA IN METALLO ROBUSTO



Cod.	cm	Conf.	Prezzo
054730	130	25	1,78 €

MANICO ALLUNGABILE



Cod.	cm	Conf.	Prezzo
054731	150	12	2,58 €

ASTA TELESCOPICA 3 M IMBIANCARE



Cod.	m	Conf.	Prezzo
000654	3	12	3,34 €

PALETTA IN PLASTICA PER POLVERE



Cod.	cm	Conf.	Prezzo
057404	22x25	1	0,55 €

SCOPINO CON PALETTA



Cod.	Descrizione	Conf.	Prezzo
003584	in plastica	12	1,84 €

ALZA IMMONDIZIA



Cod.	Descrizione	Conf.	Prezzo
028644	in acciaio zincato	24	3,65 €

ALZA IMMONDIZIA



Cod.	Descrizione	Conf.	Prezzo
003026	in plastica	6	2,81 €

ALZA IMMONDIZIA ROBUSTO

Altezza 90 cm.



Cod.	Descrizione	Conf.	Prezzo
054732	manico acciaio	12	4,89 €

ALZA IMMONDIZIA DUCK PIÙ

Alzaimmondizia con baffo in gomma, solido manico in metallo e piedino posteriore ferma-paletta.



Cod.	Misure cm	Conf.	Prezzo
023365	27x27x84	12	5,38 €

ALZA IMMONDIZIA



Cod.	Descrizione	Conf.	Prezzo
004457	in acciaio zincato	24	8,27 €

ALZA IMMONDIZIA TIRAMI SU'

In acciaio colorato.
Zincato e verniciato.



Cod.	Colore	Conf.	Prezzo
004458	verde	6	11,50 €
004459	azzurro	6	11,50 €
004460	rosso	6	11,50 €
004461	giallo	6	11,50 €

PALETTA ALZA IMMONDIZIA

Modello Beverly.



Cod.	Misure cm	Conf.	Prezzo
059613	35	12	11,90 €

SPAZZOLA PULIZIA TERMOSIFONE



Cod.	Descrizione	Conf.	Prezzo
009975	biforcuta	12	2,52 €

SPAZZOLA PULITERMO



Cod.	cm	Conf.	Prezzo
013963	80	12	2,08 €

SPAZZOLA CON RASCHIETTO



Cod.	Descrizione	Conf.	Prezzo
054735	con raschietto	15	4,74 €

LEVARAGNATELE FRECCIA



Cod.	Descrizione	Conf.	Prezzo
054736	senza manico	12	6,81 €

LEVARAGNATELE SPLENDOR

Senza manico.



Cod.	Descrizione	Conf.	Prezzo
030334	senza manico	12	3,56 €

PIUMINO SPEEDY ALLUNGABILE



Cod.	Descrizione	Conf.	Prezzo
030333	allungabile	12	5,04 €

RICAMBIO PIUMINO SPEEDY



Cod.	Pz	Conf.	Prezzo
028844	10	24	4,15 €

SPAZZOLA SOLAR PER PANNELLI SOLARI

Kit pulizia pannelli fotovoltaici. Spazzola con paraurti gomma e microfibra antigraffio. Manico telescopico predisposto al passaggio dell'acqua. Attacco rapido acquastop. Blocco portapanno e pannello in fibra.



Cod.	cm	Conf.	Prezzo
141326	150/410	1	77,60 €

LAVAVETRO TELESCOPICO



Cod.	cm	Conf.	Prezzo
011009	20	1	8,67 €

TERGIVETRO CON STRIZZATORE TELESCOPICO



Cod.	Descrizione	Conf.	Prezzo
023363	cromato	6	22,25 €

LAVAVETRO CON SPUGNA



Cod.	Descrizione	cm	Conf.	Prezzo
011005	-	25	1	6,40 €
011006	ricambio spugna	25	12	2,93 €

SPATOLA CON PUNTALE



Cod.	cm	Conf.	Prezzo
012734	25	1	5,33 €
040870	35	1	6,08 €
011001	45	1	6,82 €

VELOMOP CON MANICO E STAFFA

Staffa 40 cm con spugna bagnata e manico, 20 veli umidificati, ideale per catturare polvere e lucidare qualsiasi superficie.



Cod.	Descrizione	Conf.	Prezzo
PN01225	attrezzo + spugna + veli	1	9,11 €

RICAMBIO VELOMOP

Panno in TNT impregnato di sostanze minerali biodegradabili. Utilizzabile con staffa o senza.



Cod.	cm	Pz	Conf.	Prezzo
PN01226	22x60	20	1	1,51 €

SUPERMOP MAGICO



Cod.	cm	Conf.	Prezzo
PN01220	40	1	8,27 €

RICAMBIO SUPERMOP



Cod.	cm	Conf.	Prezzo
PN01221	45	1	4,96 €

MOCIO MOPPONE



Cod.	Descrizione	Conf.	Prezzo
054748	senza manico - 300 g	24	3,85 €

SCOPAMOP IN COTONE CON STAFFA

In cotone con frange e tasche. Lavabile in lavatrice a 60°.



Cod.	cm	Conf.	Prezzo
PN01222	45	1	8,27 €

MOCIO FURBO IN MICROFIBRA



Cod.	Descrizione	Conf.	Prezzo
054749	con frange - 140 g	12	3,56 €

RICAMBIO SCOPAMOP IN COTONE

In cotone con frange e tasche. Lavabile in lavatrice a 60°.



Cod.	cm	Conf.	Prezzo
PN01223	45	1	4,96 €

MOCIO SUPER



Cod.	Descrizione	Conf.	Prezzo
054750	ecologico	24	1,93 €

MOCIO IN COTONE



Cod.	Descrizione	Conf.	Prezzo
054746	filo continuo - 160 g	12	2,67 €

MOCIO SVELTO



Cod.	Descrizione	Conf.	Prezzo
054747	senza manico - 220 g	24	3,41 €

RICAMBIO SUPERMOCIO VILEDA



Cod.	Descrizione	Conf.	Prezzo
063678	senza manico	1	5,10 €

SUPERMOCIO VILEDÄ

Nuovo strizzatore che permette di strizzare con 40% di sforzo in meno.



Cod.	Descrizione	Conf.	Prezzo
PN01235	con bastone e fiocco	1	

SUPER MOCIO CON MANICO 3 SEZIONI

Sistema ideale per la pulizia dei pavimenti ed ora col nuovo strizzatore Torsion Powerti permette di avere una strizzatura più efficace con meno fatica.



Cod.	lt	Conf.	Prezzo
059341	10	1	20,90 €

LAVAPAVIMENTI REVOLUTION SISTEMA

Set completo di secchio e sistema lavapavimenti. Con panno 2in1 in microfibra per rimuove facilmente lo sporco.



Cod.	Descrizione	Conf.	Prezzo
063030	set completo di panno	1	28,90 €
063035	ricambio	1	7,93 €

SECCHIO PER MOCIO CON STRIZZATORE



Cod.	Descrizione	Conf.	Prezzo
026679	in plastica	12	4,44 €

SPINGIACQUA PLASTICA

Senza manico.



Cod.	cm	Conf.	Prezzo
009687	44	6	3,11 €

SPINGIACQUA PLASTICA

Senza manico.



Cod.	cm	Conf.	Prezzo
054751	55	12	3,70 €

SPINGIACQUA INDUSTRIALE IN METALLO



Cod.	cm	Conf.	Prezzo
004309	60	12	6,52 €
004310	75	12	7,67 €

SPATOLA GRANDE DOPPIA



Cod.	cm	Conf.	Prezzo
012738	55	12	5,69 €

STRACCIO CANDIDO GIGANTE



Cod.	Descrizione	Conf.	Prezzo
026829	43x60 cm	25	1,60 €

PANNO MICROFIBRA FURBETTO

Fibra magnetica catturasporco.



Cod.	Descrizione	Conf.	Prezzo
054757	vetri e specchi	12	1,57 €

PANNO MICROFIBRA PAVIMENTI



Cod.	Descrizione	Conf.	Prezzo
054755	in microfibra	12	1,57 €

PANNO MICROFIBRA FURBETTO MULTIUSO



Cod.	Descrizione	Conf.	Prezzo
054756	multiuso	12	1,57 €

SPUGNA MAGICA

Elimina sporco, macchie, muffa, impronte, da pavimenti, pareti e arredi.



Cod.	Pz	Conf.	Prezzo
030819	2	12	2,22 €

PANNO FURBETTO



Cod.	Descrizione	Pz	Conf.	Prezzo
054760	in microfibra	5	24	5,18 €

PANNO MICROFIBRA COLORS

Panno multiuso 100% microfibra, fantasie assortite.



Cod.	cm	Pz	Conf.	Prezzo
059343	30x30	8	10	10,20 €

PANNO MICROFIBRA COLORS PAVIMENTI

Panno colorato in 100% microfibra.



Cod.	cm	Pz	Conf.	Prezzo
059340	40x50	2	12	5,49 €

SPUGNA MILLEUSI ONDATIVA COLORS 3+1

Spugna da cucina abrasiva e antigraffio ideale per pulire le padelle antiaderenti e le superfici delicate. Diversi colori.



Cod.	Descrizione	Conf.	Prezzo
059342	colori assortiti	16	2,83 €

SPUGNA ABRASIVA VERDE/GIALLA



Cod.	cm	Conf.	Prezzo
026118	9x14x2,5	10	0,53 €

SPUGNA ABRASIVA



Cod.	Pz	Conf.	Prezzo
054763	1	72	0,77 €

SPUGNA ABRASIVA CON IMPUGNATURA



Cod.	Pz	Conf.	Prezzo
054764	3	48	1,22 €

FIBRA SCROSTATUTTO PROFESSIONALE



Cod.	Pz	Conf.	Prezzo
054766	3	24	2,22 €

SPAZZOLA PER BUCATO



Cod.	Descrizione	Conf.	Prezzo
054769	in trebbia naturale	6	4,59 €
054770	in trebbia sintetica	6	2,34 €

CARTA PURA CELLULOSA

Carta in pura cellulosa a 2 veli.
Lavorazione froffata incollata
Dimensioni foglio 240x215 mm.
Ogni confezione contiene 200 fogli.



Cod.	Pz	Conf.	Prezzo
062911	15	1	34,10 €

CARTA PURA CELLULOSA SANDI

Goffrata 2 veli.
Strappo 24x25,5.
2,7 kg.



Cod.	Descrizione	Conf.	Prezzo
054395	800 strappi	2	6,58 €

CARTA PURA CELLULOSA VELI FEMY

Carta in pura cellulosa a 3 veli.
Dimensioni fogli 215x240 mm.
Lavorazione groffata incaollata.



Cod.	Descrizione	Conf.	Prezzo
062910	208 strappi		2,94 €

CARTA PURA CELLULOSA

Strappo 24x25,5.
3,7 kg.



Cod.	Strappi	kg	Conf.	Prezzo
047RC	800	1,9	2	8,74 €

PORTAROTOLO A TERRA



Cod.	Descrizione	Conf.	Prezzo
8005	a terra	1	26,95 €

PORTAROTOLO A MURO



Cod.	Descrizione	Conf.	Prezzo
8010	a muro	1	15,60 €

PEZZAME SFORBICIATO LENZUOLA

10 kg.



Cod.	Descrizione	Conf.	Prezzo
15001	maglietta	1	4,73 €
15004	lenzuola	1	6,60 €

PEZZAME MISTO COLORATO

10 kg.



Cod.	Descrizione	Conf.	Prezzo
15003	misto colorato	1	2,55 €

SECCHIO PLASTICA INDUSTRIALE CON BECCO



Cod.	Colore	Capacità lt	Conf.	Prezzo
050340	Bianco	9	10	6,27 €
050341	Bianco	12	10	7,30 €
050342	Bianco	15	10	8,85 €

BACINELLA QUADRA



Cod.	cm	lt	Conf.	Prezzo
050661	33X31X15	10	15	4,22 €
050662	38x36x17	15	15	5,14 €

SECCHIO PLASTICA INDUSTRIALE CON BECCO



Cod.	Colore	Capacità lt	Conf.	Prezzo
009434	Nero	15	10	5,67 €

BACINELLA ROTONDA



Cod.	Ø cm	Conf.	Prezzo
050333	35	20	3,51 €
050334	40	20	4,91 €
050335	45	20	6,34 €
050659	52 (pesante)	10	11,90 €
050660	57 (pesante)	10	12,70 €

SECCHIO PLASTICA CASALINGO



Cod.	Capacità lt	Conf.	Prezzo
050336	7	10	4,04 €
050337	9	10	4,45 €
050338	12	10	5,56 €
050339	15	10	6,76 €

BACINELLA OVALE



Cod.	cm	Conf.	Prezzo
003547	45	5	5,18 €
003548	50	5	7,15 €
003549	55	5	8,20 €
003550	60	5	10,90 €
003551	65	5	13,30 €
003552	70	5	15,70 €
003553	80	5	19,75 €

SECCHIO ZINCATO

In zinco.



Cod.	lt	Conf.	Prezzo
PN00043	5	20	7,49 €
PN00044	8	12	10,35 €
PN00045	10	12	11,70 €
PN00046	12	12	13,65 €

**MASTELLO
TRE MANICI**



Cod.	cm	Capacità lt	Conf.	Prezzo
003532	45x33	30	5	12,25 €
003533	50x36	43	5	15,25 €
003534	55x37	60	5	20,90 €
003535	60x41	78	5	24,85 €
003536	65x43	83	5	29,60 €
003537	70x51	120	5	39,10 €

**MOLLETTA BUCATO
GIGANTI IN LEGNO**



Cod.	Pz	Conf.	Prezzo
054768	20	24	2,08 €

**MOLLETTA PER
BUCATO CREMONESI**

Antiruggine, molla in acciaio.



Cod.	Pz	Conf.	Prezzo
008767	10	50	1,04 €

MOLLETTA BUCATO



Cod.	Pz	Conf.	Prezzo
015963	in acciaio inox	100	2,22 €

**MOLLETTA BUCATO
IN PLASTICA**

Colori assortiti.



Cod.	Pz	Conf.	Prezzo
030807	20	25	2,22 €

**STENDIBIANCHERIA DA BALCONE
IN ALLUMINIO GIACINTO**

In alluminio anodizzato.



Cod.	Descrizione	Conf.	Prezzo
PN00530	superficie 10 m	1	23,45 €

STENDIBIANCHERIA DA BALCONE PEGGY

In resina.



Cod.	cm	kg	Conf.	Prezzo
81300072	26x75x108	1,8	1	11,60 €

STENDIBIANCHERIA A TORRE

In acciaio.



Cod.	Descrizione	cm	Conf.	Prezzo
PN00534	superficie 20 m	66x60x148	30	44,90 €

**STENDIBIANCHERIA DA
TERMOFONE BABY**

In alluminio anodizzato.



Cod.	Descrizione	Conf.	Prezzo
PN00533	superficie 4 m	1	12,05 €

STENDIBIANCHERIA PER RADIATORE SCALDASALVIETTE

In polipropilene. È applicabile a scaldasalviette con tubi scaldanti da Ø 18-26 mm e con una distanza minima tra 10-17 mm.



Cod.	cm	Conf.	Prezzo
PN01294	51x32	6	8,00 €

STENDIBIANCHERIA RESINA DONATELLO

Dimensioni:
53x173
(34x105x34)
h 113 cm.



Cod.	Descrizione	Conf.	Prezzo
054893	superficie 20 m	1	23,40 €

STENDIBIANCHERIA RESINA NANNI CON RUOTE E PORTAMOLLETTE

Dimensioni:
55x175 (36x103x36)
h 115 cm.



Cod.	Descrizione	Conf.	Prezzo
054892	superficie 20 m	1	30,00 €

STENDIBIANCHERIA ALLUMINIO NEW ATLANTIK

Griglia
in alluminio
anodizzato,
gambe in acciaio.



Cod.	Descrizione	Conf.	Prezzo
PN00531	superficie 18 m	4	34,70 €

STENDIBIANCHERIA A CAVALLETTO STENDI- PIÙ

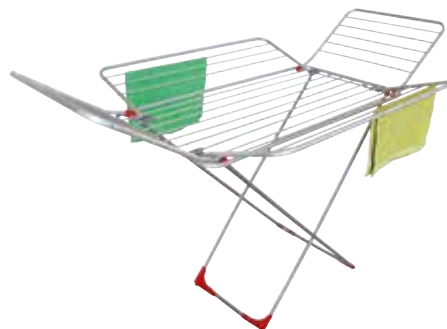

Cod.	Descrizione	Conf.	Prezzo
PN00532	superficie 30 m	3	44,20 €

CORDA ACCIAIO OTTONATO PLASTIFICATO BIANCA



Cod.	Ø mm	m	Conf.	Prezzo
041121	4,5	10	20	3,58 €

CORDA ACCIAIO OTTONATO PLASTIFICATO



Cod.	Ø mm	m	Conf.	Prezzo
041122	4	10	20	1,99 €
041124	6	10	20	3,17 €
039436	6	20	15	6,31 €

CORDA ACCIAIO ZINCATO PLASTIFICATO



Cod.	Ø mm	m	Conf.	Prezzo
041125	4	10	20	3,16 €
041126	5	10	20	4,02 €



CAVETTO D'ACCIAIO ZINCATO IL BIANCONE IN MATASSA



CAVETTO d'acciaio zincato rivestito con speciale PVC bianco anticorrosione, con fascetta descrittiva e termoretraibile. Carico di rottura 450 kg circa.



Cod.	Ø esterno mm	Ø interno mm	m	Conf.	Prezzo
02.01.012	4,5	2,5	10	40	5,55 €

CAVETTO STENDIBIANCHERIA



Acciaio ottonato. Rivetto in PVC. Antitorsione. Carico di rottura 250 kg. Bianco.



Cod.	Ø mm	m	Conf.	Prezzo
FU-2987	4,5	20	1	5,02 €

CAVETTO D'ACCIAIO IL BIANCONE IN ROTOLO



CAVETTO d'acciaio ottonato o zincato rivestito con speciali PVC bianchi anticorrosione. Carico di rottura 450 kg circa.



Cod.	Ø mm	m	Conf.	Prezzo
02.01.200	4,5	200	4	91,40 €

CORDA ACCIAIO OTTONATO PLASTIFICATO BIANCA



CAVETTO d'acciaio zincato rivestito con speciale PVC bianco anticorrosione, in bobina flangiata. Carico di rottura 450 kg circa.



Cod.	Ø mm	m	Conf.	Prezzo
02.01.500	4,5	500	1	194,00 €

MORSETTO PLASTICA FILETTATO PER BIANCONE



Cod.	Descrizione	Conf.	Prezzo
M07751	dispenser 100 pz	12	29,40 €

TENDICAVO TIRA-TIRA BOX ESPOSITORE



Cod.	Pz	Conf.	Prezzo
054800	16	12	28,15 €

STENDIBIANCHERIA PER BALCONE PIEGHEVOLE

Ferromicaceo modello pieghevole 3 posizioni. Prodotto esclusivo. Stop alle chiavi ed utensili, velocità e semplicità d'installazione, stop alle bombolette spray.



Cod.	Descrizione	Conf.	Prezzo
063248	versione con pomoli	12	19,20 €

STENDIBIANCHERIA PER BALCONE FISSO

Ferromicaceo modello fisso con piastra antisbattimento. Prodotto esclusivo. Stop alle chiavi ed utensili, velocità e semplicità d'installazione, stop alle bombolette spray.



Cod.	Descrizione	Conf.	Prezzo
063251	versione normale	12	9,47 €

STENDIBIANCHERIA A MURO PIEGHEVOLE

Il particolare sistema costruttivo permette di poter utilizzare il prodotto in due posizioni: riposo e stenditura. Dotato di piastre di fissaggio alla parete. Incluso nel kit, anche 8 viti truciolari e 8 tasselli da 8 mm per il fissaggio delle piastre.



Cod.	Descrizione	Conf.	Prezzo
063250	ribaltabile zincato	12	11,80 €

STENDIBIANCHERIA DA BALCONE

Il particolare sistema costruttivo permette di poter utilizzare il prodotto in tre posizioni: riposo, stenditura esterna e stenditura interna. Dotato di piastre di fissaggio alla ringhiera del balcone è un articolo versatile ed universale. Oltre alla doppia staffa in dotazione tutto l'occorrente per l'assemblaggio.



Cod.	Descrizione	Conf.	Prezzo
063249	ribaltabile zincato	12	11,80 €

FERRO DA STIRO CERAMICO

Piastra in ceramica, vapore verticale. funzione self clean.



Cod.	W	Conf.	Prezzo
PN01113	2200	1	28,10 €

FERRO DA STIRO DA VIAGGIO

Ferro da viaggio compatto con vapore verticale per rinfrescare i tessuti dopo ogni viaggio. Piastra in acciaio inox resistente ai graffi e scorrevole su tutti i tessuti. Doppio voltaggio, regolazione di temperatura e vapore continuo, funzione stiro a secco. Pratico Travel Bag per portarlo comodamente in viaggio.



Cod.	W	Conf.	Prezzo
PN00521	800	1	29,05 €

ASSE DA STIRO COLOR

Regolazione d'altezza in 10 posizioni fino a 92 cm, poggiaferro rinforzato con inserti in silicone, foderina 100 % cotone. Colore: fucsia con foderina Parigi / Magic Flower, Verde acido con foderina Roma / Magic Flower 2.



Cod.	cm	kg	Conf.	Prezzo
052346	114 x 36	4,5	10	32,90 €

ASSE DA STIRO PROFY



Cod.	cm	Altezza cm	Conf.	Prezzo
036057	120x40	95	2	36,40 €

SPAZZOLA CARTA ADESIVA PULIRELLA



Cod.	m	Conf.	Prezzo
052911	10	10	1,84 €

OLIO MACCHINA DA CUCIRE



Cod.	ml	Conf.	Prezzo
005423	50	1	1,49 €

SACCO SALVASPAZIO CON VALVOLA

Confezione da 2 pz.



Cod.	cm	Conf.	Prezzo
027760	70x90	10	5,01 €
027761	80x120	10	6,22 €

SACCHETTI SALVASPAZIO

Con valvola per sottovuoto. 4 diverse profumazioni. Lavanda, rosa, vaniglia, oceano.



Cod.	cm	Conf.	Prezzo
PN00067	136x98	72	5,10 €

PATTUMIERA A PEDALE



Cod.	Capacità lt	cm	Colore	Conf.	Prezzo
050350	18	29x34x41	bianca	1	19,05 €
050352	18	29x34x41	grigia	1	19,05 €

PATTUMIERA BASCULINA



Cod.	Capacità lt	cm	Colore	Conf.	Prezzo
050358	50	43x39x76	bianca	1	23,70 €

PATTUMIERA ECOPLUS MONOSPORTELLO

In plastica.



Cod.	Capacità lt	cm	Colore	Conf.	Prezzo
061890	20	34,5x34,5x34,5	verde	2	8,89 €
061891	20	34,5x34,5x34,5	blu	2	8,89 €
061892	20	34,5x34,5x34,5	giallo	2	8,89 €
061893	20	34,5x34,5x34,5	mix 3x2 pz	1	51,20 €

PATTUMIERA ECOLOGICA DOPPIO SPORTELLO

In plastica.



Cod.	Capacità lt	cm	Colore	Conf.	Prezzo
061886	28	38x36,5x37	verde	3	13,65 €
061887	28	38x36,5x37	blu	3	313,60 €
061888	28	38x36,5x37	giallo	3	13,60 €
061889	28	38x36,5x37	mix 3x3	1	117,50 €

PATTUMIERA ECOPLUS MONOSPORTELLO

In plastica.



Cod.	Capacità lt	cm	Colore	Conf.	Prezzo
061894	35	43x36x43,5	verde	2	12,00 €
061895	35	43x36x43,5	blu	2	12,00 €
061896	35	43x36x43,5	giallo	2	12,00 €
061897	35	43x36x43,5	mix 3x2 pz	1	68,80 €

BIDONCINO PORTARIFIUTI DUSTY

Capacità 25 lt. Coperchio due chiusure esterne.



Cod.	cm	Colore	Conf.	Prezzo
056768	40x45	verde	1	12,80 €
056769	40x45	blu	1	12,80 €
056770	40x45	giallo	1	12,80 €
056771	40x45	rosso	1	12,80 €

BIDONE IMMONDIZIA GRIGIO E COPERCHIO COLORATO

Capacità 100 lt. Con maniglia ergonomica e rinforzata, coperchio con chiusura a clip e ruote antisdrucchiolo.



Cod.	cm	Colore	Conf.	Prezzo
PN00658B	49x54x85	blu	1	41,90 €
PN00658G	49x54x85	giallo	1	41,90 €
PN00658R	49x54x85	rosso	1	41,90 €
PN00658V	49x54x85	verde	1	41,90 €

BIDONE IMMONDIZIA

Colore verde.
In polietilene alta densità PE-HD.
Con ruote da 200 mm.
Resistente agli agenti chimici.
Lavabile e sterilizzabile.
Peso 9,2 kg.



Cod.	lt	cm	Conf.	Prezzo
PN00659	120	48x55x93h	1	62,00 €

BIDONE PLASTICA VERDE

Senza coperchio.



Cod.	Capacità lt	cm	Conf.	Prezzo
050371	50	41x49	1	16,20 €
050372	75	44x63	1	21,00 €
050373	100	53x66	1	29,40 €
050374	120	53x79	1	36,70 €

TREPOLO GRIGLIATO

Colore verde. In polipropilene.



Cod.	lt	cm	Conf.	Prezzo
PN00652	110	h 85,5 x Ø 36,5/50	1	21,40 €

BIDONE IMMONDIZIA

In zinco.



Cod.	lt	Conf.	Prezzo
PN00051	35	8	26,45 €
PN00052	62	6	38,30 €

COPERCHIO PER BIDONE



Cod.	Colore	cm	Conf.	Prezzo
050375	nero	41	12	2,14 €
050376	nero	44	12	4,17 €
050377	nero	53	12	5,51 €
050378	verde	41	12	3,19 €
050379	verde	44	12	6,30 €
050380	verde	53	12	8,68 €

BIDONE CON FERMASACCO

Per sacchetto da 72x110 cm.
Per la raccolta di tutti i dispositivi di protezione individuale, ICS ha studiato un contenitore con anello fermasacchetto fisso con ampia apertura che permette di non entrare MAI A CONTATTO con i rifiuti.
Per una MASSIMA SICUREZZA il nuovo bidone evita il fenomeno dell'aspirazione dell'aria provocato dall'apertura e dalla chiusura dei contenitori con pedale.



Cod.	Capacità lt	Conf.	Prezzo
061797	50	1	17,70 €

BIDONE PLASTICA NERO

Senza coperchio.



Cod.	Capacità lt	cm	Conf.	Prezzo
050367	50	41x49	5	10,50 €
050368	75	44x63	5	13,50 €
050369	100	53x66	4	18,65 €
050370	120	53x79	4	23,30 €

SACCO IMMONDIZIA ROTOLO 10 PEZZI



Cod.	cm	Micron	Colore	Conf.	Prezzo
057527	85x120	50	nero	15	3,86 €
061565	90x120	60	giallo	15	6,12 €
061564	90x120	60	nero	15	4,86 €

SACCO IMMONDIZIA NERO

80 Micron.



Cod.	cm	Conf.	Prezzo kg
061566	90x120	20	3,22 €

SACCO IMMONDIZIA GIALLO

80 Micron.



Cod.	cm	Conf.	Prezzo kg
061567	90x120	20	4,35 €

SACCO IMMONDIZIA



Cod.	cm	Colore	Pz	Conf.	Prezzo
NS70001	50x60	nero	20	50	1,25 €
NS70002	55x65	celeste	15	50	1,43 €
NS70005	72x110	trasparente	10	30	2,57 €
NS70003	72x110	nero	10	25	2,11 €

SACCO IMMONDIZIA

20 gr.



Cod.	cm	Colore	Pz	Conf.	Prezzo
059301	72x110	neutro	10	1	1,78 €
059302	72x110	azzurro	10	1	1,75 €
059303	72x110	verde	10	1	1,75 €

SACCHETI PATTUMIERA PER UMIDO BIODEGRADABILE

In rotolo da 25 pezzi.



Cod.	cm	Pz	Conf.	Prezzo
057528	42x44	25	1	2,50 €

SHOPPERS COMPOSTABILE RICICLABILE



Cod.	cm	Pz	Conf.	Prezzo
052474	22+6+6x42	1000	1	72,00 €
051526	26+6+6x50	500	1	45,80 €
051527	30+9+9x60	500	1	73,50 €

SACCHETTO CARTA



Cod.	Misura	g	Conf.	Prezzo
FU-9212	12x28	9	1000	0,03 €

BORSA ECO BIO



Cod.	Misura	g	Conf.	Prezzo
FU-9211	25+7+7x50	9	500	0,10 €

SHOPPERS BAG PESANTE



Cod.	Misura	Conf.	Prezzo
FU-9210	44+20x38	1	1,67 €

CARRELLO MODULA

In plastica. Con ruote.
Versatile con vaschette estraibili.



Cod.	cm	Colore	Conf.	Prezzo
062003	41,5x29xh19,5	tortora	1	21,95 €
061898	41,5x29xh19,5	rosso	1	21,95 €

MOBILE TUTTOPIANI LINEA STEEL

Sistema anti-usura con cerniere in acciaio che garantiscono una chiusura a scatto. Prodotti in polipropilene, materiale antiurto, resistente al freddo, alle intemperie, agli oli e ai solventi.



Cod.	cm	Conf.	Prezzo
PN00650	70x39x172 h	1	117,50 €

MOBILE PORTASCOPE LINEA STEEL

Sistema anti-usura con cerniere in acciaio che garantiscono una chiusura a scatto. Prodotti in polipropilene, materiale antiurto, resistente al freddo, alle intemperie, agli oli e ai solventi.



Cod.	cm	Conf.	Prezzo
PN00651	70x39x165h	1	117,50 €

ARMADIO LINEA STEEL

Sistema antiusura con cerniere in acciaio che garantiscono una chiusura a scatto. Prodotti in polipropilene, materiale antiurto, resistente al freddo, alle intemperie, agli oli e ai solventi.



Cod.	cm	Conf.	Prezzo
PN00656	70x39x85 h	1	65,00 €

BAULE

In polipropilene, compatto, robusto e capiente, resistente a freddo, intemperie, oli e solventi. Montaggio semplice e veloce, senza l'utilizzo di utensili. Prodotto con plastica riciclata e riciclabile.



Cod.	cm	Conf.	Prezzo
PN00653	95x53xh57	1	71,40 €

PENSILINA DA ESTERNO

In kit di facile montaggio, può essere montata da sola o in serie. Struttura in ABS nero, copertura in policarbonato neutro.



Cod.	cm	Conf.	Prezzo
SG1882	100x80	1	52,40 €
SG1880	120x100	1	76,50 €
SG1881	150x100	1	92,40 €

ZERBINO MILLEPUNTE

Colore verde.



Cod.	cm	Conf.	Prezzo
SI1792	68x34	20	11,50 €

PANNELLI RIVESTIMENTO PLASTONDA

Lastra in polipropilene alveolare 50x100 cm, molto resistente, con stampa serigrafica su una sola facciata. È ideale come rivestimento per tutte quelle pareti che hanno bisogno di essere rivestite o mascherate in modo rapido, sicuro ed economico. Molto leggero e flessibile. È resistente all'acqua, all'umidità ed alle intemperie, rendendo così questa lastra utilizzabile in vari ambienti.



Cod.	Modello	Conf.	Prezzo
058072	vintage	5	12,20 €
058073	saloon	5	12,20 €
058074	pietra	5	12,20 €
058075	brick	5	12,20 €

SPECCHIO PLASTICO CON FORI ARGENTO

Colore argento. Spessore 3 mm.



Cod.	cm	Conf.	Prezzo
SP6040A	60x40	5	19,20 €

LASTRA VETRO SINTETICO TRASPARENTE



Cod.	Descrizione	Conf.	Prezzo
FU-5500	25x50 cm spessore 2 mm	10	2,14 €
FU-5501	50x50 cm spessore 2 mm	10	4,31 €
FU-5502	50x100 cm spessore 2 mm	10	8,59 €
FU-5503	50x125 cm spessore 2 mm	10	10,80 €
FU-5504	50x150 cm spessore 2 mm	10	12,90 €
FU-5510	25x50 cm spessore 4 mm	5	4,31 €
FU-5511	50x50 cm spessore 4 mm	5	8,59 €
FU-5512	50x100 cm spessore 4 mm	5	17,20 €
FU-5513	50x125 cm spessore 4 mm	5	21,50 €
FU-5514	50x150 cm spessore 4 mm	5	25,80 €

LASTRA POLIONDA VARI COLORI



Cod.	Descrizione	Conf.	Prezzo
PO5050A	azzurro 50x50 cm sp.2,5 mm	8	2,11 €
PO5050B	bianco 50x50 cm sp.2,5 mm	8	2,11 €
PO5050G	giallo 50x50 cm sp.2,5 mm	8	2,11 €
PO5050N	nero 50x50 cm sp.2,5 mm	8	2,11 €
PO5050NT	neutro 50x50 cm sp.2,5 mm	8	2,11 €
PO5050R	rosso 50x50 cm sp.2,5 mm	8	2,11 €
PO5050S	silver 50x50 cm sp.2,5 mm	8	2,11 €
PO5050V	verde 50x50 cm sp.2,5 mm	8	2,11 €
PO50100A	azzurro 50x100 cm sp.2,5 mm	8	4,16 €
PO50100B	bianco 50x100 cm sp.2,5 mm	8	4,16 €
PO50100G	giallo 50x100 cm sp.2,5 mm	8	4,16 €
PO50100N	nero 50x100 cm sp.2,5 mm	8	4,16 €
PO50100NT	neutro 50x100 cm sp.2,5 mm	8	4,16 €
PO50100R	rosso 50x100 cm sp.2,5 mm	8	4,16 €
PO50100S	silver 50x100 cm sp.2,5 mm	8	4,16 €
PO50100V	verde 50x100 cm sp.2,5 mm	8	4,16 €

BATTISEDIA TRASPARENTE CON BIADESIVO



Cod.	cm	Conf.	Prezzo
BS1280T	12x80	25	6,79 €

POLIKRISTAL TRASPARENTE



Cod.	h cm	Spessore mm	Conf.	Prezzo
PK1001000T	100	0,25	100	3,76 €

ATTACCAGLIE FISSE IN OTTONE IN BLISTER



Cod.	Descrizione	Pz	Conf.	Prezzo
841042	n° 1	16	12	1,04 €
841037	n° 2	6	12	0,96 €

ATTACCAGLIE SNODATE IN OTTONE IN BLISTER



Cod.	Descrizione	Pz	Conf.	Prezzo
841046	n° 1	15	12	1,04 €

ATTACCAGLIE TELA IN BLISTER



Cod.	Descrizione	Pz	Conf.	Prezzo
841045	in tela	6	12	1,04 €

CHIODINI IN OTTONE IN BLISTER



Cod.	Descrizione	Pz	Conf.	Prezzo
841050	per ganci X	100	12	0,98 €
001844	per ganci X	100	30	0,56 €

CHIODINI IN ACCIAIO TESTA IN OTTONE IN BLISTER



Cod.	Descrizione	Pz	Conf.	Prezzo
841055	20 mm	20	12	1,04 €
841056	25 mm	18	12	1,04 €
841057	30 mm	15	12	1,04 €

GANCIO GIGLIO MICRO IN BLISTER



Cod.	mm	Colore	Pz	Conf.	Prezzo
841065	24	argento	6	12	0,98 €
841066	24	bronzo	6	12	0,98 €
841067	24	oro	6	12	0,98 €

GANCIO GIGLIO PICCOLO IN BLISTER



Cod.	mm	Colore	Pz	Conf.	Prezzo
841070	33	argento	5	12	0,98 €
841071	33	bronzo	5	12	1,04 €
841072	33	oro	5	12	1,04 €

GANCIO GIGLIO GRANDE IN BLISTER



Cod.	mm	Colore	Pz	Conf.	Prezzo
841075	47	argento	3	12	1,04 €
841076	47	bronzo	3	12	1,04 €
841077	47	oro	3	12	1,04 €

GANCIO GOCCIA ORO IN BLISTER



Cod.	mm	Pz	Conf.	Prezzo
841081	27	3	12	0,98 €

GANCIO GOCCIA CROMO IN BLISTER



Cod.	mm	Pz	Conf.	Prezzo
841082	27	3	12	1,04 €

GANCIO POLO CROMO IN BLISTER



Cod.	mm	Pz	Conf.	Prezzo
841085	20	4	12	1,20 €

GANCIO POLO ORO IN BLISTER

DIESE



Cod.	mm	Pz	Conf.	Prezzo
841086	20	4	12	1,20 €

GANCIO TIPO BLITZ TRASPARENTE IN BLISTER

DIESE



Cod.	Pz	Conf.	Prezzo
841090	20	12	1,04 €

GANCIO APPENDITUTTO IN NYLON

SIM



Cod.	Pz	Conf.	Prezzo
S1192	10	60	2,10 €

GANCI X

DIESE



Cod.	Descrizione	Pz	Conf.	Prezzo
841094	n° 2	6	12	1,04 €

GANCIO X BLISTER

DIESE



Cod.	Descrizione	Pz	Conf.	Prezzo
841095	n° 0	10	12	1,20 €
001837	n° 1	10	30	0,54 €
841094	n° 2	10	12	1,04 €

GANCIO X IN BLISTER

DIESE



Cod.	Descrizione	Pz	Conf.	Prezzo
841097	n° 3	5	12	1,20 €

GANCIO X PIENO IN BLISTER

DIESE



Cod.	Descrizione	Pz	Conf.	Prezzo
841100	n° 3	4	12	1,20 €

RAMPINO CON STOP IN BLISTER

DIESE



Cod.	Descrizione	Pz	Conf.	Prezzo
841115	con stop	10	12	0,98 €

RAMPINO CON STOP

DIESE



Cod.	Pz	Conf.	Prezzo
841116	10	30	0,73 €

PUNTINE DA DISEGNO

DIESE



Cod.	Colore	Pz	Conf.	Prezzo
841105	bianche	70	30	0,91 €
841106	blu	70	30	0,91 €
841107	assortite	70	30	0,91 €
841108	gialle	70	30	0,91 €
841110	nere	70	30	0,91 €
841111	rosse	70	30	0,91 €
841112	verdi	70	30	0,91 €

ANELLO TENDA CROMO BLISTER

DIESE



Cod.	Pz	Conf.	Prezzo
841120	6	12	3,62 €

ANELLO TENDA IN FERRO BATTUTO BLISTER **DIESE**



Cod.	Pz	Conf.	Prezzo
841121	6	12	3,62 €

ANELLO TENDA OTTONE SPAZZOLATO BLISTER **DIESE**



Cod.	Pz	Conf.	Prezzo
841123	6	12	5,21 €

ANELLO TENDA RAME SPAZZOLATO IN BLISTER **DIESE**



Cod.	Pz	Conf.	Prezzo
841124	6	12	5,21 €

GANCIO NYLON QUADRI TURBOFIX 3 PUNTE



GEKO

Cod.	Pz	Conf.	Prezzo
797500	10	60	1,49 €

GANCIO NYLON QUADRI TURBOFIX 1 PUNTA



GEKO

Cod.	Pz	Conf.	Prezzo
797505	20	60	1,49 €

GANCIO ADESIVO BRIS METALLO BIANCO **DIESE**



Cod.	Ø mm	Conf.	Prezzo
841125	25	100	0,58 €

GANCIO ADESIVO BRIS METALLO BIANCO IN BLISTER **DIESE**



Cod.	Ø mm	Pz	Conf.	Prezzo
841144	25	2	6	0,98 €
841137	25	4	6	0,98 €

GANCIO ADESIVO BRIS METALLO BRONZO **DIESE**



Cod.	Ø mm	Conf.	Prezzo
841127	25	100	0,58 €

GANCIO ADESIVO BRIS METALLO BRONZO IN BLISTER **DIESE**



Cod.	Ø mm	Pz	Conf.	Prezzo
841133	25	2	6	0,98 €

GANCIO ADESIVO BRIS METALLO CROMO **DIESE**



Cod.	Ø mm	Conf.	Prezzo
841128	25	100	0,58 €

GANCIO ADESIVO BRIS METALLO CROMO IN BLISTER **DIESE**



Cod.	Ø mm	Pz	Conf.	Prezzo
841132	25	2	6	0,96 €

GANCIO ADESIVO BRIS METALLO ORO



Cod.	Ø mm	Conf.	Prezzo
841130	25	100	0,58 €

GANCIO ADESIVO BRIS METALLO ORO IN BLISTER



Cod.	Ø mm	Pz	Conf.	Prezzo
841131	25	4	20	2,88 €

GANCI PER BRIS METALLO IN BLISTER



Cod.	Colore	Pz	Conf.	Prezzo
841135	bianco	4	12	1,04 €

GANCI PER BRIS METALLO OX BLISTER



Cod.	Pz	Conf.	Prezzo
841136	4	12	1,04 €

GANCIO BRIS PLASTICATO



Cod.	Colore	Pz	Conf.	Prezzo
841140	bianco	100	1	11,00 €

GANCIO BRIS PLASTICATO



Cod.	Colore	Pz	Conf.	Prezzo
841141	marrone	100	1	11,00 €

GANCIO BRIS PLASTICATO OX



Cod.	Pz	Conf.	Prezzo
841142	100	1	11,00 €

GANCIO BRIS PLASTICATO OX IN BLISTER



Cod.	Pz	Conf.	Prezzo
841143	6	6	0,98 €

GUAINA SPIRALINO + ACCESSORI



Cod.	mt	Conf.	Prezzo
841145	50	50	0,45 €

GUIDA TENDE A MOLLA ECO

Colore bianco.



Cod.	cm	Pz	Conf.	Prezzo
007404	40	2	1	1,48 €
007405	50	2	1	1,56 €
007406	60	2	1	1,70 €

GUIDA PER TENDE ESTENSIBILE TONDY UNIVERSALE CP



Cod.	mm	Colore	Conf.	Prezzo
841150	27/36	bianco	10	2,66 €
841151	36/60	bianco	10	3,34 €
841152	63/110	bianco	10	4,76 €

GUIDA TONDY CROMO UNIVERSALE CP



Cod.	mm	Conf.	Prezzo
841153	27/36	10	2,92 €
841154	36/60	10	4,13 €
841155	63/110	10	6,03 €

GUIDA TONDY ORO UNIVERSALE CP

DIESE



Cod.	mm	Conf.	Prezzo
841156	27/36	10	2,92 €
841157	36/60	10	4,13 €
841158	63/110	10	6,03 €

GUIDA DUCHESSA CP

DIESE



Cod.	mm	Colore	Conf.	Prezzo
841176	27/36	oro	10	2,97 €
841177	36/60	oro	10	4,21 €
841178	63/110	oro	10	6,14 €

GUIDA ALLUMINIO ORO PIATTO CP

DIESE



Cod.	cm	Conf.	Prezzo
841160	27/40	20	1,85 €
841161	39/60	20	2,27 €
841162	55/90	10	2,97 €
841163	87/150	10	4,46 €

TERMOMETRO LEGNO GANCIO

DIESE



Cod.	Gancio	Conf.	Prezzo
841185	bronzo	1	6,65 €
841186	oro	1	6,65 €

GUIDA TENDA PIATTY CP

DIESE



Cod.	cm	Colore	Conf.	Prezzo
841165	27/40	bianca	10	1,08 €
841166	39/60	bianca	10	1,21 €
841167	55/90	bianca	10	1,52 €
841168	87/150	bianca	10	1,98 €

FERMATOVAGLIE

DIESE



Cod.	mm	Colore	Conf.	Prezzo
841190	40x50	nichelato	50	0,54 €
001361	40x50	bianco	50	0,61 €

GUIDA DUCHESSA CP

DIESE



Cod.	mm	Colore	Conf.	Prezzo
841170	27/36	b/oro	10	2,97 €
841171	36/60	b/oro	10	4,21 €
841172	63/110	b/oro	10	6,14 €

FERMATOVAGLIE GRANDE

DIESE



Cod.	mm	Colore	Conf.	Prezzo
841191	60x65	nichelato	30	0,74 €

GUIDA DUCHESSA CP

DIESE



Cod.	mm	Colore	Conf.	Prezzo
841173	27/36	cromo	10	2,97 €
841174	36/60	cromo	10	4,21 €
841175	63/110	cromo	10	6,14 €

MOLLE APPENDIPIATTI

DIESE



Cod.	Varie	Conf.	Prezzo
841195	n° 1	10	1,28 €
841196	n° 2	10	1,30 €
841197	n° 3	10	1,40 €

FERMAPORTE BIRILLO IN BLISTER

DIESE



Cod.	Colore	Pz	Conf.	Prezzo
841210	marrone	2	12	1,04 €

FERMAPORTE BIRILLO IN BLISTER

DIESE



Cod.	Colore	Pz	Conf.	Prezzo
841211	trasparente	2	12	1,04 €

FERMAPORTE TRAPEZIO IN BLISTER

DIESE



Cod.	Colore	Pz	Conf.	Prezzo
841212	bianco	4	12	0,98 €
841214	marrone	4	12	1,04 €

FERMAPORTE TRAPEZIO

DIESE



Cod.	Colore	Pz	Conf.	Prezzo
007297	bianco	100	1	0,17 €
841213	marrone	100	1	17,25 €

GANCIO OVALE MEDIO ASSORTITO

DIESE



Cod.	mm	Pz	Conf.	Prezzo
841217	55	100	1	28,50 €

METALGANCIO 1P

DIESE



Cod.	Colore	Pz	Conf.	Prezzo
841220	bianco	100	1	23,70 €
841221	marrone	100	1	23,70 €

SUPERGANCIO

DIESE



Cod.	Colore	Pz	Conf.	Prezzo
841225	bianco	25	1	16,25 €
841227	marrone	25	1	16,25 €

GANCIO APPENDI ASCIUGAMANO

In acciaio inossidabile satinato. Con biadesivo premontato sul retro. Ideale per appendere presine, strofinacci, utensili da cucina.



Cod.	mm	Descrizione	Conf.	Prezzo
063252	40x13	gancio piccolo	200	0,24 €
063253	60x25	gancio grande	100	0,33 €

GANCIO SMERALDO BLISTER

DIESE



Cod.	Colore	Pz	Conf.	Prezzo
841230	bianco	2	6	3,84 €
841231	cromo	2	6	3,84 €
841232	oro	2	6	3,84 €
841233	rame	2	6	3,84 €

GANCIO A S IN BLISTER

DIESE



Cod.	mm	Colore	Pz	Conf.	Prezzo
841346	52	ferro battuto	4	12	2,32 €
841348	52	ottone spazzolato	4	12	2,32 €
841349	52	rame spazzolato	4	12	2,32 €

VENTOSA CON GANCIO IN PLASTICA

DIESE



Cod.	mm	Tipo	Conf.	Prezzo
841350	60	alpina	25	1,27 €
841352	65	tenax	20	1,36 €

VENTOSA CON GANCIO FILETTATO

DIESE



Cod.	mm	Conf.	Prezzo
841351	40	100	0,27 €

GANCIO LEGNO 2P

DIESE



Cod.	Colore	Conf.	Prezzo
841236	noce/bronzo	8	4,42 €

GANCIO LEGNO 3P

DIESE



Cod.	Colore	Conf.	Prezzo
841238	noce/bronzo	6	6,17 €

PORTABITI LADY

DIESE



Cod.	Colore	Conf.	Prezzo
841245	bianco	8	2,41 €
841246	bronzo	8	3,05 €
841247	cromo	8	3,05 €
841248	ferro battuto	8	2,41 €
841250	nero	8	2,41 €
841251	oro	8	3,05 €
841252	rame	8	3,05 €

PORTABITI SEVEN IN LEGNO

DIESE



Cod.	Colore	Conf.	Prezzo
841240	bianco	2	11,00 €
841241	frassino	2	11,00 €
841242	noce	2	11,00 €

TAPPO COPRIFORO

DIESE



Cod.	Colore	Conf.	Prezzo
841300	bianco	10	1,09 €
841301	cromato	10	1,09 €

ANTIURTO MANIGLIA 1 FORO

DIESE



Cod.	Pz	Conf.	Prezzo
017817	100	1	0,21 €

ANTIURTO MANIGLIA

DIESE



Cod.	mm	Conf.	Prezzo
841310	200x130	100	0,12 €

ANTIURTO MANIGLIA IN BLISTER

DIESE



Cod.	mm	Pz	Conf.	Prezzo
841311	200x130	4	12	0,98 €

CINTURINO ANTIURTO

DIESE



Cod.	mm	Conf.	Prezzo
841315	60x140	60	0,37 €

PARASPIGOLO ANGOLARE ADESIVO

DIESE



Cod.	mm	Colore	PZ	Conf.	Prezzo
841343	33x33	trasparente	-	50	0,56 €
841344	33x33	trasparente	2	6	1,04 €

GOMMINI PER SEDIE CONICI



Cod.	mm	Colore	Pz	Conf.	Prezzo
841325	25	bianco	4	30	0,89 €
841326	25	nero	4	30	0,89 €

GOMMINI PER SEDIE IN BLISTER



Cod.	mm	Colore	Pz	Conf.	Prezzo
841330	25	bianco	8	12	1,04 €
841331	25	nero	8	12	1,04 €

TAPPO SOTTOSEDIA INTERNO



Cod.	mm	Conf.	Prezzo
052627	18	200	0,05 €
052628	20	200	0,06 €
052629	22	200	0,07 €
052630	25	200	0,09 €
052631	28	200	0,13 €
052632	30	200	0,14 €
052633	35	200	0,19 €
052634	40	200	0,23 €

TAPPO PASSACAPO

In plastica.



Cod.	Ø mm	colore	Conf.	Prezzo
052657	60	bianco	50	1,15 €
052658	80	bianco	50	0,97 €
052659	60	marrone	50	1,15 €
052660	80	marrone	50	1,22 €
052661	60	nero	50	1,22 €
052662	80	nero	50	1,22 €

PARACOLPO MORBIDO ADESIVO



Cod.	Ø mm	Pz	Conf.	Prezzo
841335	10x3	50	30	0,99 €

FELTRINI TONDI



Cod.	Colore	mm	Pz	Conf.	Prezzo
852000	bianco	18	12	50	0,25 €
852002	bianco	22	10	50	0,25 €
852004	bianco	24	8	50	0,25 €
852006	bianco	26	8	50	0,25 €
852008	bianco	32	4	50	0,25 €
852010	bianco	40	2	50	0,25 €
852011	bianco	50	2	50	0,25 €
852012	marrone	18	12	50	0,25 €
852014	marrone	22	10	50	0,25 €
852016	marrone	24	8	50	0,25 €
852018	marrone	26	8	50	0,25 €
852019	marrone	28	6	50	0,25 €
8520195	marrone	30	6	50	0,25 €
852020	marrone	32	4	50	0,25 €
852022	marrone	40	2	50	0,25 €
852024	marrone	50	2	50	0,25 €

FELTRINI QUADRATI



Cod.	Colore	mm	Pz	Conf.	Prezzo
852030	bianco	20x20	10	50	0,25 €
852032	bianco	25x25	8	50	0,25 €
852034	bianco	30x30	6	50	0,25 €
852036	bianco	40x40	2	50	0,25 €
852038	marrone	20x20	10	50	0,25 €
852040	marrone	25x25	8	50	0,25 €
852042	marrone	30x30	6	50	0,25 €
852044	marrone	40x40	2	50	0,25 €

FELTRINI RETTANGOLARI



Cod.	Colore	mm	Pz	Conf.	Prezzo
852050	bianco	25x50	1	50	0,25 €
852052	bianco	50x100	1	50	0,25 €
841322	bianco	100x100	1	50	17,20 €
852054	marrone	25x50	1	50	0,25 €
852056	marrone	50x100	1	50	0,25 €
852057	marrone	100x100	1	50	0,25 €

FLESSIBILE PER DOCCIA

Aggraffatura doppia, dado F1/2 conico e F1/2 normale zigrinato.

BL17800025
BL17800030



Cod.	Attacco cm	Conf.	Prezzo
RB8820	150	1	5,46 €
RB8825	200	1	7,26 €

FLESSIBILE PER DOCCIA

Aggraffatura doppia, dado F1/2 conico e F1/2 normale zigrinato. Alta qualità.



Cod.	Attacco cm	Conf.	Prezzo
RB9030	150	1	9,44 €
RB9035	200	1	11,70 €

RICAMBIO PER FLESSIBILE

Per miscelatori livello cucina o estraibili.

BL17800070



Cod.	Attacco	cm	Conf.	Prezzo
PI780021	M15A x F1/2 conico	150	10	11,40 €

LACCIO DOCCIA

In PVC bianco antitorsione. In blister.



Cod.	L cm	Ø mm	Conf.	Prezzo
PI780032	150	14	20	12,05 €

FLESSIBILE DOCCIA

Flessibile in doccia in Biflex spiralato colore cromo/bianco, dado F1/2 conico liscio con OR F1/2 normale zincato.

BL17800060



Cod.	cm	Conf.	Prezzo
PI780042	150	10	6,76 €

SALISCENDI PER DOCCIA QUARZO

Cromato. In blister.



Cod.	Descrizione	Conf.	Prezzo
PI780100	doccetta monofunzione	10	23,70 €

SALISCENDI PER DOCCIA TOPAZIO

Laccio doccia in acciaio doppia aggraffatura 150 cm. Asta H 60 cm - Ø 22 mm. Doccetta H 25 cm - Ø 10 cm. In blister.



Cod.	Descrizione	Conf.	Prezzo
PI780103	doccetta 5 funzioni	10	33,50 €

SALISCENDI PER DOCCIA AVORIO

Laccio doccia in acciaio doppia aggraffatura 150 cm. Asta H 67 cm - Ø 30 mm. Doccetta H 27 cm - Ø 12 cm. In blister.



Cod.	Descrizione	Conf.	Prezzo
PI780105	doccetta 5 funzioni	10	48,90 €

SALISCENDI PER DOCCIA EXTRA

Interasse regolabile. Laccio doccia in acciaio doppia aggraffatura 150 cm. Asta regolabile H 75 cm - Ø 22 mm. Doccetta H 25 cm - Ø 10 cm. In blister.



Cod.	Descrizione	Conf.	Prezzo
RB7010	doccetta 5 funzioni	24	39,20 €

ASTA PER SALISCENDI

Con portasapone. In blister.



Cod.	H cm	Ø cm	Conf.	Prezzo
PI780122	60	22	10	21,35 €

RICAMBIO PORTASAPONE



Cod.	Descrizione	Conf.	Prezzo
PI780140	ricambio portasapone	10	5,85 €

SCORREVOLE RICAMBIO PER SALISCENDI

Per mod. Giada, Gemma, Smeraldo. (315LN-315S-315LG).



Cod.	Ø mm	Conf.	Prezzo
PI780150	25	10	5,36 €

SCORREVOLE RICAMBIO PER SALISCENDI

Per mod. Opale, Turchese. (315QN e 315FN).



Cod.	Ø mm	Conf.	Prezzo
PI780155	22	10	3,73 €

DOCCEtta MONO FUNZIONE QUARZO

In ABS cromo. In blister.



Cod.	H cm	Ø mm	Conf.	Prezzo
BL17800105	20	7	10	7,56 €

DOCCEtta OTTO FUNZIONI TURCHESE

In ABS cromo. In blister.



Cod.	H cm	Ø mm	Conf.	Prezzo
BL17800125	22	8	20	10,90 €

DOCCEtta CINQUE FUNZIONI TOPAZIO

In ABS cromo/satinato. In blister.



Cod.	H cm	Ø mm	Conf.	Prezzo
BL17800145	25	10	20	14,55 €

DOCCEtta CINQUE FUNZIONI AVORIO

In ABS cromo. In blister.



Cod.	H cm	Ø mm	Conf.	Prezzo
BL17800135	27	12	20	19,60 €

DOCCEtta TRE FUNZIONI GEMMA

In ABS cromo con supporto. In blister.



Cod.	H cm	Ø mm	Conf.	Prezzo
BL17800165	26	16	20	19,90 €

DOCCEtta CINQUE FUNZIONI MAXI

Risparmio idrico del 40%. In blister.



Cod.	H cm	Ø cm	Conf.	Prezzo
68910090	25	9,2	20	14,00 €

DOCCEtta

BL17800175



Cod.	Descrizione	Conf.	Prezzo
PI780245	per gruppi vasca normale	10	7,08 €

DOCCEtta CURVA

BL17800180



Cod.	Descrizione	Conf.	Prezzo
PI780250	per duplex normale	10	8,30 €

DOCCEtta PESANTE

Cromata. Per miscelatori lavello cucina estraibili.

BL17800190



Cod.	Descrizione	Conf.	Prezzo
PI780260	cromata	5	9,06 €

SOFFIONE DOCCIA UN GETTO

In ABS cromato e satinato. In blister.



Cod.	Ø cm	Conf.	Prezzo
PI780270	10	24	12,60 €

SOFFIONE DOCCIA MONOGETTO

In metallo cromato con anticalcare.

BL17800205



Cod.	Descrizione	Conf.	Prezzo
PI780280	in metallo cromato	10	11,70 €

SOFFIONE DOCCIA MONOGETTO

In ABS cromo anticalcare. Ugelli in caucciù. In blister.



Cod.	Ø cm	Conf.	Prezzo
PI780290	16	10	13,35 €

SOFFIONE DOCCIA MONOGETTO

In ABS cromo anticalcare. Ugelli in caucciù. In blister.



Cod.	Ø cm	Conf.	Prezzo
RB7120	22,5	10	32,00 €

SOFFIONE DOCCIA MERCURY

In ABS.

BL17800225



Cod.	Descrizione	Conf.	Prezzo
PI780300	cromo/nero	10	6,30 €

SOFFIONE DOCCIA CON SNODO

In lastra di ottone cromato.

BL17800150



Cod.	Descrizione	Conf.	Prezzo
PI780315	con snodo	10	11,10 €

CURVETTA PER SALISCENDI

In ottone cromato con rosone.

BL17800240



Cod.	Misura	Conf.	Prezzo
RB8850	1/2 M x 1/2 M	20	5,19 €

SUPPORTO ESTERNO

BL17800245
BL17800075



CART PICC



Cod.	Descrizione	Conf.	Prezzo
PI780450	per doccetta duplex in ottone	10	7,08 €
PI780451	per doccetta attacco conico	10	6,76 €

BRACCIO DOCCIA FUSO MEDIO

BL17800160



PLAC



Cod.	cm	Conf.	Prezzo
PI780325	1/2x20	10	7,67 €

BRACCIO DOCCIA LEGGERO FISSO

Senza rosone.

BL17800155



CART PICC



Cod.	cm	Conf.	Prezzo
PI780320	1/2x30	10	10,45 €

MISCELATORE MONOCOMANDO LAVABO 1" 1/4 SERIE FLAVIA

FDA



MADE IN ITALY

Cod.	Descrizione	Conf.	Prezzo
PI780550	per lavabo	1	77,10 €

MISCELATORE MONOCOMANDO BIDET 1" 1/4 SERIE FLAVIA

FDA



MADE IN ITALY

Cod.	Descrizione	Conf.	Prezzo
PI780555	per bidet	1	71,40 €

MISCELATORE MONOCOMANDO VASCA FLEX E DOCCETTA SERIE FLAVIA

FDA



MADE IN ITALY

Cod.	Descrizione	cm	Conf.	Prezzo
PI780560	per vasca flex e doccetta	120	1	106,50 €

MISCELATORE DOCCIA DA ESTERNO SERIE FLAVIA

FDA

Solo doccia senza accessori.



MADE IN ITALY

Cod.	Descrizione	Conf.	Prezzo
PI780558	per doccia da esterno	1	75,50 €

MISCELATORE DOCCIA DA INCASSO SERIE FLAVIA

FDA



MADE IN ITALY

Cod.	Descrizione	Conf.	Prezzo
PI780565	per doccia da incasso	1	47,90 €

MISCELATORE LAVELLO LATERALE CON CANNA ALTA E OVALE SERIE FLAVIA

FDA



MADE IN ITALY

Cod.	Descrizione	Conf.	Prezzo
PI780570	per lavello canna alta e ovale	1	73,70 €

MISCELATORE MONOCOMANDO LAVELLO MONOFORO CON BOCCA GIREVOLE SERIE FLAVIA

FDA



MADE IN ITALY

Cod.	Descrizione	Conf.	Prezzo
PI780575	per lavello bocca girevole	1	60,30 €

MISCELATORE MONOCOMANDO LAVELLO A MURO CON CANNA A S SERIE FLAVIA



Cod.	Descrizione	Conf.	Prezzo
PI780580	per lavello canna a S	1	76,30 €

MISCELATORE BIDET SALTARELLO



Miscelatore monocomando per bidet, con scarico saltarello in ottone.



Cod.	Attacco	Conf.	Prezzo
063064	1" 1/4	1	59,40 €

MISCELATORE MONOCOMANDO PER LAVABO SERIE EUROPA



Ottone cromato. Con flessibile sottolavandino e piletta.



Cod.	Descrizione	Conf.	Prezzo
RB3001	per lavello	24	44,10 €

MISCELATORE MONOCOMANDO PER VASCA SERIE EUROPA



Ottone cromato con duplex. Con doccetta, supporto e flessibile.



Cod.	Descrizione	Conf.	Prezzo
RB3010	per vasca	24	52,30 €

MISCELATORE MONOCOMANDO PER BIDET SERIE EUROPA



Ottone cromato. Con flessibile sottolavandino e piletta.



Cod.	Descrizione	Conf.	Prezzo
RB3005	per bidet	24	44,80 €

MISCELATORE DOCCIA DA INCASSO



Miscelatore monocomando per doccia da incasso.



Cod.	Descrizione	Conf.	Prezzo
063065	per doccia	1	30,00 €

MISCELATORE LAVABO SALTARELLO



Miscelatore monocomando per lavabo, con scarico saltarello in ottone.



Cod.	Attacco	Conf.	Prezzo
063063	1" 1/4	1	48,00 €

MISCELATORE PER DOCCIA DA INCASSO SERIE EUROPA



Ottone cromato.



Cod.	Descrizione	Conf.	Prezzo
RB3022	per doccia	24	30,90 €

**MISCELATORE LAVELLO
CANNA IN GOMMA**

Miscelatore monocomando per lavello con canna orientabile in gomma colorata.



Cod.	Colore	Conf.	Prezzo
063058	bianco	1	66,20 €

**MISCELATORE PER LAVELLO DA CUCINA
SERIE EUROPA**



Cod.	Descrizione	Conf.	Prezzo
RB5030	per lavello cucina	24	42,40 €

**MISCELATORE LAVELLO
CANNA IN GOMMA**

Miscelatore monocomando per lavello con canna orientabile in gomma colorata.



Cod.	Colore	Conf.	Prezzo
063059	nero	1	66,20 €

CARTUCCIA PER MISCELATORE



Cod.	Descrizione	Ø mm	Conf.	Prezzo
PI780600	senza distribuzione	40	1	9,14 €
PI780605	con distribuzione	40	1	9,14 €

**MISCELATORE LAVELLO
CANNA IN GOMMA**

Miscelatore monocomando per lavello con canna orientabile in gomma colorata.



Cod.	Colore	Conf.	Prezzo
063060	grigio	1	66,20 €

**GRUPPO LAVABO CON SCARICO
AUTOMATICO 1" 1/4
SERIE TRADIZIONALE**



Cod.	Descrizione	Conf.	Prezzo
PI780515	batteria lavabo	1	90,80 €

**MISCELATORE PER LAVELLO MONOFORO
CANNA ALTA SERIE EUROPA**

Con flessibile sottolavandino.



Cod.	Descrizione	Conf.	Prezzo
RB5045	per lavello canna alta	24	42,50 €

**GRUPPO BIDET CON SCARICO
AUTOMATICO 1" 1/4
SERIE TRADIZIONALE**



Cod.	Descrizione	Conf.	Prezzo
PI780520	batteria bidet	1	54,20 €

**GRUPPO VASCA CON DOCCIA E FLESSIBILE
SERIE TRADIZIONALE**



Cod.	Descrizione	cm	Conf.	Prezzo
PI780510	gruppo vasca	120-150	1	82,60 €

**RUBINETTO CROMATO SNODO PESANTE E
CANNA A S SERIE TRADIZIONALE**

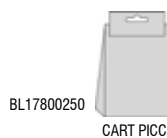

Cod.	Descrizione	Conf.	Prezzo
PI780585	snodo a S	6	21,00 €

**GRUPPO LAVELLO MONOFORO
CANNA A J
SERIE TRADIZIONALE**



Cod.	Descrizione	Conf.	Prezzo
PI780500	per lavello canna a J	1	50,20 €

CANNA A SNODO

Attacco universale da 3/4.

BL17400005
BL17400010



Cod.	cm	Conf.	Prezzo
PI740000	20	10	10,60 €
PI740005	25	10	11,05 €

**GRUPPO LAVELLO A PARETE CON CANNA A S
SERIE TRADIZIONALE**



Cod.	Descrizione	Conf.	Prezzo
PI780505	per lavello canna a S	1	52,20 €

CANNA MOD. JOTA

BL17400015



Cod.	Attacco	Conf.	Prezzo
PI740010	universale da 3/4	10	10,15 €

**KIT VITONI UNIVERSALI
PER RUBINETTI**



Cod.	Pz	Conf.	Prezzo
PI180035	5	1	17,20 €

CANNA PONTE

Attacco universale da 3/4.

BL17400020
BL17400025



Cod.	cm	Conf.	Prezzo
PI740015	20	10	11,20 €
PI740020	25	10	11,85 €

AERATORE PER RUBINETTI



Cod.	Tipo	Conf.	Prezzo
841260	F 22x1	30	0,28 €
841261	M 24X1	30	0,45 €

AERATORE FEMMINA PER RUBINETTI

In ottone cromato con filtro.

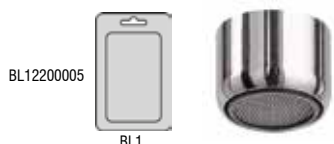

Cod.	Attacco	Conf.	Prezzo
PI220000	22x1	10	0,99 €

AERATORE MASCHIO PER RUBINETTI

In ottone cromato con filtro.



Cod.	Attacco	Conf.	Prezzo
PI220005	24x1	10	0,91 €

AERATORE MASCHIO PER RUBINETTI

In ottone cromato con filtro.



Cod.	Attacco	Conf.	Prezzo
PI220010	28x1	10	1,44 €

AERATORE MINIMALISTA PER RUBINETTI



Cod.	Attacco	Conf.	Prezzo
PI220018	F Ø 16	10	2,04 €
PI220019	M Ø 18	10	2,03 €

AERATORE A SNODO M PER BIDET

In ottone cromato.



Cod.	Attacco	Conf.	Prezzo
PI220015	Ø 24	10	4,19 €

KIT AERATORE



Cod.	Descrizione	Conf.	Prezzo
BL12200040	4 pz Ø 22	50	3,43 €
BL12200050	3 pz Ø 22 + 1 pz Ø28	100	2,94 €

INTERNO PER AERATORE IN PLASTICA

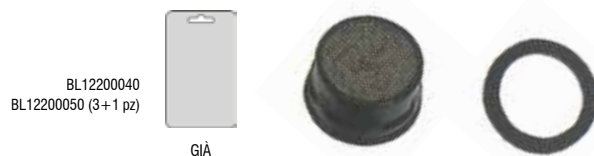

Cod.	Attacco	Conf.	Prezzo
PI220020	Ø 22/24	100	0,74 €
PI220022	Ø 28	100	0,88 €

INTERNO PER AERATORE IN PLASTICA

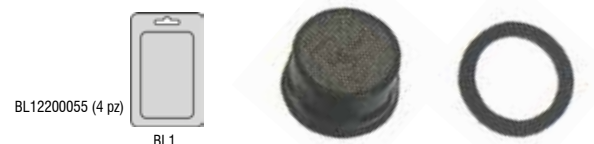

Cod.	Descrizione	Attacco	Conf.	Prezzo
PI220025	limitatore portata 60 lt/min	Ø 22/24	50	1,05 €

INTERNO PER AERATORE



Cod.	Attacco	Conf.	Prezzo
PI220026	Ø 22/24	10	0,42 €

RIDUZIONE IN OTTONE CROMATO PER AERATORE



Cod.	Attacco	Conf.	Prezzo
PI220029	M24 x M22	25	2,00 €

RIDUZIONE PER AERATORE

In ottone cromato per attacco flex doccia. Adatto per mix-rub con attacco maschio.

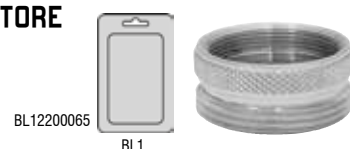

Cod.	Attacco	Conf.	Prezzo
PI220030	F22 x M1/2	25	2,46 €

RIDUZIONE PER AERATORE

In ottone cromato per attacco flex doccia. Adatto per mix-rub con attacco maschio.

BL12200070

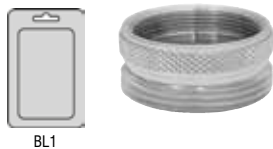

BL1

Cod.	Attacco	Conf.	Prezzo
PI220035	F22 x M3/4	25	2,76 €

RIDUZIONE IN OTTONE CROMATO PER AERATORE

Per attacco flex doccia. Adatto per mix-rub con attacco maschio.

BL12200073



BL1

Cod.	Attacco	Conf.	Prezzo
PI220039	M24 x M1/2	25	3,53 €

RIDUZIONE IN OTTONE PER RUBINETTI

In ottone giallo.

BL17800080



BL1

Cod.	Attacco	Conf.	Prezzo
PI550010	3/8x1/2	50	1,10 €

ROMPIGETTO AERATORE/DOCCETTA

Con snodo cromato.

BL12200075



BL3

Cod.	Attacco	Conf.	Prezzo
PI220040	F22	10	3,22 €

ROMPIGETTO SIRIUS CROMATO



Cod.	Descrizione	Filetto F	Filetto M	Conf.	Prezzo
PI220270	nero	22x1M	24x1M	25	4,34 €

ROMPIGETTO SIRIUS CROMATO



Con snodo ottone.



Cod.	Descrizione	Filetto F	Filetto M	Conf.	Prezzo
PI220280	nero	22x1M	24x1M	30	6,16 €

ROMPIGETTO SIRIUS CROMATO



Con doppio snodo e ghiera in ottone. Economizzatore incorporato.



Cod.	Descrizione	Filetto F	Filetto M	Conf.	Prezzo
PI220290	nero	22x1F	24x1M	30	6,95 €

ROMPIGETTO AERATORE CROMATO



Con doppio snodo. In blister.



Cod.	Descrizione	Filetto F	Filetto M	Conf.	Prezzo
PI220200	bianco	22x1M	24x1M	30	5,68 €

ROMPIGETTO AERATORE DOCCETTA CROMATO CON SNODO



Per rubinetti senza filettatura sino a Ø 20 mm. In blister.



Cod.	Descrizione	Conf.	Prezzo
PI220210	bianco/nero	20	6,10 €

ROMPIGETTO AERATORE DOCCETTA CROMATO



Per rubinetti senza filettatura sino a Ø 20 mm. In blister.



Cod.	Descrizione	Conf.	Prezzo
PI220220	bianco/nero	30	5,01 €

CANNUCCIA ROMPIGETTO CON AERATORE DOCCETTA CROMATO



Per rubinetti senza filettatura sino a Ø 20 mm. Cannuccia rompigetto da 15 cm. In blister.



Cod.	Descrizione	Conf.	Prezzo
PI220230	bianco/nero	25	5,39 €

CANNUCCIA ROMPIGETTO SIRIUS BIANCA SIROFLEX

In blister.



Cod.	Descrizione	cm	Filetto F	Conf.	Prezzo
PI220250	ghiera in ottone	14	22x1M	20	6,95 €

CANNUCCIA ROMPIGETTO SIRIUS EXTRA SIROFLEX

In blister.



Cod.	Descrizione	cm	Filetto F	Conf.	Prezzo
PI220260	ghiera in ottone	14	22x1M	20	7,27 €

CANNUCCIA FLESSIBILE TIPO LUSO SIROFLEX

Integralmente in ottone cromato, doppia aggraffatura e dotata di rompigetto Sirius cromato/nero. Ghiera con filetto F 22x1M. In blister.

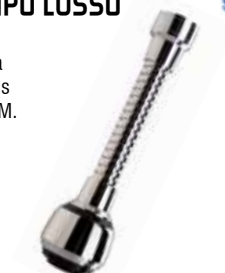

Cod.	Descrizione	cm	Conf.	Prezzo
PI220240	ottone cromato	14	20	11,75 €

CANNUCCIA CROMATA

Per rubinetti con filettatura femmina 22. In blister.

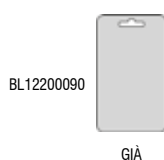

BL12200090

GIÀ

Cod.	Descrizione	Conf.	Prezzo
BL12200090	aeratore/doccetta	10	5,23 €

GHIERA ABS CROMATA PER FORO TROPPO PIENO



BL12200350
BL12200351
BL12200352

BL1

Cod.	Ø mm	Conf.	Prezzo
PI310000	19	10	0,69 €
PI310001	24	10	0,69 €
PI310002	28	10	0,77 €

SALTARELLO LEGGERO CROMATO



Cod.	mm	Tipo	Conf.	Prezzo
841280	36,5	bidet	10	1,32 €
841281	39,5	lavabo	10	1,32 €

TAPPO SALTARELLO PESANTE CROMATO

Per piletta lavabo/bidet.

BL12200100
BL12200105



BL3/BL5



Cod.	Descrizione	Attacco	Conf.	Prezzo
PI220100	standard	1" Ø 36	20	3,70 €
PI220105	standard	1"1/4 Ø 39	20	3,69 €

TAPPO SALTERELLO CROMATO

Per piletta vasca.

BL12200110



BL5



Cod.	Descrizione	Attacco	Conf.	Prezzo
PI220110	standard	Ø 42	20	4,15 €

COPRIFORO PESANTE

BL12200115



BL5



Cod.	Descrizione	Conf.	Prezzo
PI220115	in ottone cromato	20	2,28 €

TAPPO NERO CON PLACCA INOX E CATENA

Confezione a fasci da 25 pz.

BL12200117
BL12200120
BL12200125
BL12200130
BL12200135
BL12200140



BL1



Cod.	Ø mm	Conf.	Prezzo
PI220119	27	25	2,10 €
PI220120	31	25	2,14 €
PI220122	40	25	2,22 €
PI220124	44	25	2,34 €
PI220126	47	25	2,43 €
PI220128	52	25	2,53 €

TAPPO NERO CON MANIGLIA E PLACCA INOX

BL12200147



BL2



Cod.	Ø mm	Conf.	Prezzo
PI220145	52	25	1,11 €

TAPPO NERO CON MANIGLIA

BL12200145



BL1



Cod.	Ø mm	Conf.	Prezzo
PI220140	52	50	0,54 €

TAPPO SCARICO CON MANIGLIA



Cod.	Ø mm	Conf.	Prezzo
019598	52	25	1,14 €

FILTRO IN PLASTICA

Per lavello e lavabo.

BL12200150
BL12200155
BL12200160



BL5



Cod.	Ø mm	Conf.	Prezzo
012158	31	50	0,21 €
008252	40	50	0,21 €
001358	50	50	0,20 €

GRIGLIETTA CROMATA PER LAVABO

BL12200165



BL4



Cod.	Descrizione	Conf.	Prezzo
PI220160	in ABS	50	1,36 €

GRIGLIA BASKET PER SECCHIAIO

BL12200010



PLAC



Cod.	Descrizione	Conf.	Prezzo
841275	in acciaio inox	10	2,57 €

GRIGLIA GRANDE PER SECCHIAIO

BL17800220



PLAC



Cod.	Descrizione	Conf.	Prezzo
841277	in acciaio inox	25	0,64 €

GRIGLIETTA PER LAVABO

BL12200170



BL4



Cod.	Descrizione	Conf.	Prezzo
841276	in acciaio inox	100	0,38 €

ESPOSITORE TAPPO UNIVERSALE SCATTINO

BL12200098



CART PICC



Cod.	Pz	Conf.	Prezzo
PI220180	18	1	98,30 €

TUBO FLESSIBILE IN TRECCIA

In acciaio inox. 7 fili - DN 10. Maschio e dado normale.



Cod.	Attacco	cm	Conf.	Prezzo
PI100000	M1/2 x F1/2	25	25	3,06 €
PI100001	M1/2 x F1/2	30	25	3,18 €
PI100002	M1/2 x F1/2	35	25	3,34 €
PI100003	M1/2 x F1/2	40	25	3,50 €
PI100005	M1/2 x F1/2	50	25	3,75 €
PI100015	M3/8 x F1/2	25	25	3,06 €
PI100016	M3/8 x F1/2	30	25	3,18 €
PI100017	M3/8 x F1/2	35	25	3,34 €
PI100020	M3/8 x F1/2	40	25	3,50 €
PI100025	M3/8 x F3/8	25	25	3,06 €
PI100026	M3/8 x F3/8	30	25	3,18 €
PI100027	M3/8 x F3/8	35	25	3,34 €
PI100028	M3/8 x F3/8	40	25	3,50 €
PI100030	M1/2 x F3/8	25	25	3,06 €
PI100031	M1/2 x F3/8	30	25	3,18 €
PI100032	M1/2 x F3/8	35	25	3,34 €
PI100035	M1/2 x F3/8	40	25	3,50 €
PI100045	F1/2 x F1/2	25	25	3,06 €
PI100046	F1/2 x F1/2	30	25	3,18 €
PI100047	F1/2 x F1/2	35	25	3,34 €
PI100050	F1/2 x F1/2	40	25	3,50 €
PI100055	F1/2 x F3/8	25	25	3,06 €
PI100056	F1/2 x F3/8	30	25	3,18 €
PI100057	F1/2 x F3/8	35	25	3,34 €
PI100060	F1/2 x F3/8	40	25	3,50 €
PI100071	F3/8 x F3/8	30	25	3,18 €
PI100075	F3/8 x F3/8	40	25	3,50 €

TUBO FLESSIBILE IN TRECCIA

In acciaio Inox 8 fili - DN10. Maschietto pesante. Maschio biconico 3 pz, 3/8 x Ø10.



BL11000130

PLAC

Cod.	Attacco	cm	Conf.	Prezzo
PI100100	M1/2 x BIC 10	35	25	3,53 €

TUBO FLESSIBILE IN TRECCIA

In acciaio Inox. 7 fili - DN8. Maschietto dado normale.



BL11000135

BL11000140

PLAC+GUARN

Cod.	Attacco	cm	Conf.	Prezzo
PI100130	M10 x 1 mm x F3/8	35	25	3,15 €
PI100135	M10 x 1 mm x F1/2	35	25	3,15 €

TUBO FLESSIBILE IN TRECCIA

In acciaio inox. 7 fili - DN 10. Maschio e dado normale.



PLAC+GUARN

Cod.	Attacco	cm	Conf.
BL11000005	M1/2 x F1/2	25	25
BL11000010	M1/2 x F1/2	30	25
BL11000015	M1/2 x F1/2	35	25
BL11000020	M1/2 x F1/2	40	25
BL11000025	M1/2 x F1/2	50	25
BL11000030	M3/8 x F1/2	25	25
BL11000035	M3/8 x F1/2	30	25
BL11000040	M3/8 x F1/2	35	25
BL11000045	M3/8 x F1/2	40	25
BL11000050	M3/8 x F3/8	25	25
BL11000055	M3/8 x F3/8	30	25
BL11000060	M3/8 x F3/8	35	25
BL11000065	M3/8 x F3/8	40	25
BL11000070	M1/2 x F3/8	25	25
BL11000075	M1/2 x F3/8	30	25
BL11000080	M1/2 x F3/8	35	25
BL11000085	M1/2 x F3/8	40	25
BL11000090	F1/2 x F1/2	25	25
BL11000095	F1/2 x F1/2	30	25
BL11000100	F1/2 x F1/2	35	25
BL11000105	F1/2 x F1/2	40	25
BL11000110	F1/2 x F3/8	25	25
BL11000115	F1/2 x F3/8	30	25
BL11000120	F1/2 x F3/8	35	25
BL11000125	F1/2 x F3/8	40	25
BL12200185	F3/8 x F3/8	30	25
BL12200190	F3/8 x F3/8	40	25

TUBO FLESSIBILE PER AUTOCLAVE

In acciaio zincato.



Cod.	Attacco	cm	Conf.	Prezzo
PI100150	1/2	40	25	5,01 €
PI100151	1/2	60	25	6,15 €
PI100152	1/2	80	25	7,29 €
PI100155	3/4	40	25	8,42 €
PI100156	3/4	60	25	10,30 €
PI100157	3/4	80	25	12,20 €
PI100160	1"	40	25	12,55 €
PI100161	1"	60	25	14,40 €
PI100162	1"	80	25	16,80 €

RACCORDO CROMATO A BICONO DOPPIO

Completo di dado 3/8 svasato, ranella ottone fresata Ø 10 mm, ranella ottone piana Ø 10 mm, guarnizione gomma piana Ø 10 mm.

BL11000300



Cod.	Attacco	Conf.	Prezzo
PI100300	10x10 (3/8)	25	5,52 €

RACCORDO CROMATO A BICONO FEMMINA

Completo di dado 3/8 svasato, ranella ottone fresata Ø 10 mm, ranella ottone piana Ø 10 mm, guarnizione gomma piana Ø 10 mm.

BL11000310



Cod.	Attacco	Conf.	Prezzo
PI100365	F 1/2x3/8xØ10	25	2,92 €

RACCORDO CROMATO A BICONO MASCHIO

Completo di dado 3/8 svasato, ranella ottone fresata Ø 10 mm, ranella ottone piana Ø 10 mm, guarnizione gomma piana Ø 10 mm.

BL11000400
BL11000410



Cod.	Attacco	Conf.	Prezzo
PI100400	M 3/8x3/8xØ10	25	2,91 €
PI100410	M 1/2x3/8xØ10	25	3,41 €

RUBINETTO SOTTOLAVABO PESANTE

A vitone in ottone stampato con filtro ispezionabile, con snodo, dado alto 3/8 x Ø 10 mm, completo di 3 pz, attacco muro 1/2.

BL11400005



Cod.	Attacco	Conf.	Prezzo
PI140000	1/2 x 3/8 - Ø 10	10	10,01 €

RUBINETTO SOTTOLAVABO PESANTE A SFERA

In ottone stampato con filtro ispezionabile con snodo, dado basso 3/8xØ10 mm completo 3 pz, attacco muro 1/2.

BL11400010



Cod.	Attacco	Conf.	Prezzo
RB5060	1/2x3/8 - Ø 10	10	8,56 €

GUARNIZIONI PER RACCORDI IN BLISTER

Contiene: 5 pz Ø 3/8"; 5 pz Ø 1/2"; 5 pz Ø 3/4"; 5 pz Ø 1"; 5 pz Ø 1 1/4".



Cod.	Pz	Conf.	Prezzo
BL12600000	25	1	2,50 €

GUARNIZIONI PER RACCORDI

BL12600005
BL12600010
BL12600015
BL12600020
BL12600025
BL12600030
BL12600032



BL1/BL2/BL4/
/BL5/BL6/ BL7

Cod.	Filetto Ø	Pz	Conf.	Prezzo
2108960400	3/8"	100	1	1,82 €
2108960500	1/2"	100	1	2,24 €
2108960600	3/4"	100	1	3,08 €
2108960700	1"	100	1	3,34 €
2108960800	1 1/4"	100	1	7,84 €
2108960900	1 1/2"	100	1	10,40 €
2108961000	2"	100	1	20,15 €

GUARNIZIONE ALLUMINIO



Cod.	Misura	Pz	Conf.	Prezzo
PI260030	1/2	100	1	30,90 €

GUARNIZIONE CUOIO

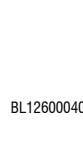

Cod.	Misura	Conf.	Prezzo
PI260035	1/2	100	0,19 €

GUARNIZIONE IN GOMMA PER SANITARI

BL11800059 (1/2")

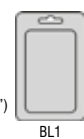

Cod.	Misura	Pz	Conf.	Prezzo
PI180059	1/2"	100	1	1,95 €
PI180060	3/4"	100	1	3,24 €
PI180061	1"	100	1	4,90 €

GUARNIZIONI PER RUBINETTI CON FORO

BL12200205
BL12200210



BL1



Cod.	Foro	Pz	Conf.	Prezzo
PI260036	3/8	100	1	10,40 €
PI260037	1/2	100	1	12,25 €

GUARNIZIONE CONICA

BL12600044
BL12600045
BL12600050

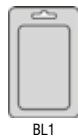

BL1



Cod.	Attacco	Pz	Conf.	Prezzo
PI260039	1" x Ø26 mm	100	1	14,70 €
PI260040	1"1/4 x Ø 30/32 mm	100	1	21,60 €
PI260045	1"1/2 x Ø 40 mm	100	1	30,60 €

GUARNIZIONE CONICA PER TUBETTO



Cod.	Misura	Pz	Conf.	Prezzo
001863	10 mm	100	1	3,10 €

ASSORTIMENTO OR

In blister.



Cod.	Misura	Pz	Conf.	Prezzo
BL12600055	dal 7 al 13 + 1"-1"1/4	24	1	3,68 €
BL12600060	dal 4 al 16	50	1	4,84 €
BL12600065	dal 17 al 20	24	1	3,70 €
BL12600070	dal 21 al 24	24	1	4,68 €

GUARNIZIONI O-RING



Cod.	Descrizione	Pz	Conf.	Prezzo
001869	assortiti	432	1	19,55 €

GUARNIZIONI O-RING



Cod.	mm	Pz	Conf.	Prezzo
001956	4,90x1,9 (n.4)	100	1	3,64 €
001957	5,70x1,9 (n.5)	100	1	3,72 €
001958	7,20x1,9 (n.6)	100	1	3,88 €
001959	8,90x1,9 (n.7)	100	1	4,20 €
001960	8,90x2,7 (n.8)	100	1	4,84 €
001961	10,5x2,7 (n.9)	100	1	5,12 €
001962	12,1x2,7 (n.10)	100	1	5,72 €
001963	13,6x2,7 (n.11)	100	1	6,80 €
001964	15,1x2,7 (n.12)	100	1	6,36 €
001965	16,9x2,7 (n.13)	100	1	6,36 €
001966	18,4x2,7 (n.14)	100	1	8,44 €
001967	19,0x3,5 (n.15)	100	1	10,05 €
001968	19,8x3,6 (n.16)	100	1	9,32 €
001969	21,3x3,6 (n.17)	100	1	10,60 €
001970	23,0x3,6 (n.18)	100	1	12,00 €
001971	24,6x3,6 (n.19)	100	1	12,00 €
001972	26,2x3,6 (n.20)	100	1	12,35 €
001973	27,8x3,6 (n.21)	100	1	12,35 €
001974	29,3x3,6 (n.22)	100	1	14,10 €
001975	30,8x3,6 (n.23)	100	1	14,50 €
001976	32,5x3,6 (n.24)	100	1	15,40 €
001977	34,1x3,6 (n.25)	100	1	17,20 €
002020	35,6x3,6 (n.26)	100	1	17,20 €
002022	37,3x3,6 (n.27)	100	1	17,20 €

STURATUBI A FILO FLEXI



Cod.	Ø mm	m	Conf.	Prezzo
004406	7	2,5	1	2,98 €
841285	7	3,5	1	3,92 €
012976	7	5,0	1	5,42 €
841364	7	7,5	1	7,48 €

STURATUBI CON GUAINA



Cod.	m	Conf.	Prezzo
PI390000	2,5	5	7,95 €
PI390001	5,0	5	12,70 €
PI390002	7,0	5	16,25 €

STURALAVANDINO



Cod.	Descrizione	Conf.	Prezzo
4670620	a pompa lunga	6	15,85 €
4670625	con 2 ventose	6	16,50 €

STURALAVANDINO



Cod.	Ø mm	Conf.	Prezzo
841290	120	10	2,36 €
841291	150	10	3,34 €

VENTOSA STURA SCARICO

Manico in legno.



Cod.	Ø mm	Conf.	Prezzo
003601	120	12	3,41 €
005222	150	6	4,00 €

STURALAVELLO A PRESSIONE



Cod.	Descrizione	Conf.	Prezzo
064002	tipo Pango	1	98,00 €

ROSONE ACCIAIO INOX

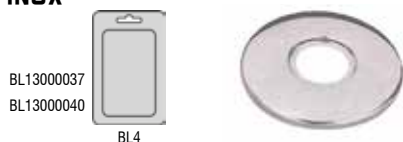

Cod.	mm	Conf.	Prezzo
PI300079	Ø 60x3/8	100	0,26 €
PI300080	Ø 60x1/2	100	0,26 €

ROSONE APRIBILE UNIVERSALE

In polipropilene bianco.



Cod.	Ø mm	Conf.	Prezzo
PI300085	da 8 a 22	100	0,17 €

ROSONE APRIBILE UNIVERSALE DOPPIO

In polipropilene bianco.

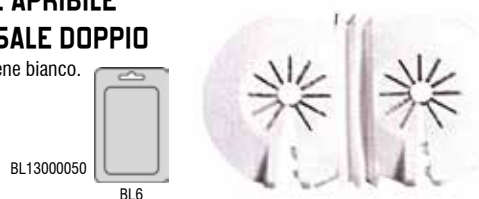

Cod.	Ø mm	Conf.	Prezzo
PI300090	da 10 a 22	100	0,63 €

ROSONE PESANTE APRIBILE UNIVERSALE

Cromato in ABS.



Cod.	mm	Conf.	Prezzo
PI300095	Ø da 8 a 22	100	1,14 €

ROSONE A CONO IN OTTONE CROMATO



Cod.	mm	Conf.	Prezzo
PI300060	H 28 Ø 75 x Ø 26 mm	50	1,32 €
PI300061	H 28 Ø 75 x Ø 30 mm	50	1,32 €
PI300062	H 28 Ø 75 x Ø 32 mm	50	1,32 €

ROSONE A CONO IN OTTONE CROMATO



Cod.	mm	Conf.	Prezzo
PI300065	H 32 Ø 75 x Ø 40 mm	25	2,49 €

RIDUZIONE IN OTTONE CROMATO CON 2 OR



Cod.	mm	Conf.	Prezzo
PI550030	Ø 32x26	10	4,61 €
PI550035	Ø 40x32	10	4,92 €

GIUNZIONE CROMATA + 2 DR



Cod.	mm	Conf.	Prezzo
143875	26	10	4,60 €
143877	32	10	5,08 €
143878	40	10	6,12 €

CANOTTO CON CARTELLA

In ottone cromato.



BL13000005
BL13000010
BL13000015
BL13000020



PLAC

Cod.	cm	Conf.	Prezzo
PI300000	Ø 26x30	10	4,15 €
PI300005	Ø 30x30	10	4,46 €
PI300010	Ø 32x30	10	4,76 €
PI300015	Ø 40x30	10	8,92 €

TUBO ALLUNGABILE

Con dado in metallo.

BL13000025
BL13000033
BL13000035



CART PICC



Cod.	Attacco	Conf.	Prezzo
PI300040	1" x Ø 32	1	2,39 €
PI300047	1"1/4 x Ø 32/40	1	2,39 €
PI300050	1"1/2 x Ø 40	1	2,38 €

SIFONE A BOTTIGLIA IN OTTONE CROMATO

BL13400050
BL13400055



BL10



Cod.	Attacco	cm	Conf.	Prezzo
PI340111	1"	20	30	14,10 €
PI340112	1" 1/4	20	30	14,65 €

SIFONE A S IN OTTONE CROMATO

BL13400060
BL13400065



BL10



Cod.	Attacco	cm	Conf.	Prezzo
PI340126	1"	20	30	15,95 €
PI340169	1" 1/4	20	30	16,00 €

SIFONE A U IN OTTONE CROMATO

BL13400070
BL13400085



BL10



Cod.	Attacco	cm	Conf.	Prezzo
PI340170	1"	20	30	15,20 €
PI340180	1" 1/4	20	30	16,15 €

SIFONE ISPEZIONABILE

1 via. Senza piletta.



Cod.	Attacco	Conf.	Prezzo
PI340008	1" 1/2	1	19,95 €

SIFONE ISPEZIONABILE

2 vie. Senza piletta.



Cod.	Attacco	Conf.	Prezzo
PI340009	1" 1/2	1	28,25 €

SIFONE MOD. PRAKTIK

1 via. In polipropilene.

BL13400012



CART GRANDE



Cod.	Attacco	Conf.	Prezzo
PI340010	1" 1/2 x Ø 40	10	15,90 €

SIFONE MOD. PRAKTIK

2 vie. In polipropilene.



Cod.	Attacco	Conf.	Prezzo
PI340015	1" 1/2 x Ø 40	10	22,75 €

SIFONE FIASCA 1 VIA

Con attacco lavatrice e tappo. In polipropilene bianco.

Con riduzione:
1" 1/2
1" 1/4

BL13400005

CART GRANDE



Cod.	Attacco	Conf.	Prezzo
PI340000	1"1/2 x Ø 40/32	10	5,67 €

SIFONE SCARICO LAVATRICE MURALE



Cod.	mm	Conf.	Prezzo
142666	18/24	1	7,90 €

SIFONE FIASCA 1 VIA CON PILETTA

Con attacco lavatrice e tappo. In polipropilene bianco.

Con riduzione:
1" 1/2
1" 1/4

BL17800130

CART GRANDE



Cod.	Attacco	Conf.	Prezzo
PI340002	1"1/2 x Ø 40/32	10	7,47 €

CURVA IN ABS BIANCO

Per attacco lavatrice. Con calotta e OR.

BL13400035

BL5



Cod.	Attacco	Conf.	Prezzo
PI340050	1"	20	0,90 €

SIFONE FIASCA 2 VIE

Con attacco lavatrice e tappo. In polipropilene bianco.

BL13400010

CART GRANDE



Cod.	Attacco	Conf.	Prezzo
PI340005	1"1/2 x Ø 40/32	10	8,30 €

PILETTA GATTINARA

Per lavelli ceramica.

BL13400015

BL13400020

CART PICC



Cod.	Attacco	Conf.	Prezzo
PI340020	1"1/4 x Ø 80	10	2,44 €
PI340022	1"1/2 x Ø 80	10	2,44 €

PILETTA STP

Senza troppo pieno. Per lavelli inox.

BL13400025

CART PICC



Cod.	Attacco	Conf.	Prezzo
PI340025	1"1/2	10	3,75 €

RIDUZIONE FILETTATA IN POLIPROPILENE

BL17800100
BL17800110
BL17800115
BL17800120

BL4



Cod.	Attacco	Conf.	Prezzo
PI550050	F 1"1/2 x M 1"1/4	100	1,11 €
PI550055	F 1"1/4 x M 1"1/2	100	1,04 €
PI550070	M 1" x F 1"1/4	100	0,82 €
PI550075	F 1" x M 1"1/4	100	1,07 €

PILETTA CPT

Con troppo pieno. Per lavelli inox.

BL13400030

BL10



Cod.	Attacco	Conf.	Prezzo
PI340027	1"1/2	10	4,60 €

CURVA PER CARICO LAVATRICE

BL11800090

BL4



Cod.	Descrizione	Pz	Conf.	Prezzo
PI180045	plastica	20	1	1,14 €

PILETTA GIGANTE CON TROPPO PIENO

Per lavelli inox.

BL13400031

BL10



Cod.	Attacco	Conf.	Prezzo
PI340030	1" 1/2 x Ø 115	10	17,05 €

PILETTA GIGANTE SENZA TROPPO PIENO

Per lavelli inox.

BL13400032



CART PICC



Cod.	Attacco	Conf.	Prezzo
PI340031	1" 1/2 x Ø 115	10	14,30 €

PILETTA LAVABO BIDET CON TROPPO PIENO

BL13400090
BL13400095



CART PICC



Cod.	Misura	Conf.	Prezzo
PI340060	1"	10	12,60 €
PI340065	1" 1/4	10	13,55 €

PILETTA SCARICO NORTON IN OTTONE CROMATO

Con tappo in ottone cromato.



BL12200250
BL12200255



CART PICC

Cod.	Attacco	Conf.	Prezzo
PI220312	1"	10	12,60 €
PI220313	1" 1/4	10	16,00 €

MORSETTO WC

In gomma bianca.

BL13800005



BL3



Cod.	mm	Conf.	Prezzo
PI380000	Ø 50x30	50	0,62 €

MORSETTO WC MAGGIORATO PESANTE

In gomma bianca.

BL13800010
BL13800015



BL4



Cod.	mm	Conf.	Prezzo
PI380005	Ø 60x30	50	0,65 €
PI380007	Ø 60x40	50	1,41 €

IMBUTO CONICO IN PARA

BL13400034



BL9



Cod.	Descrizione	Conf.	Prezzo
PI380010	in para	50	1,27 €

MORSETTO

Tipo Won Roll/Redi.

BL13800020



BL3



Cod.	mm	Conf.	Prezzo
PI380015	Ø 40x26	50	0,72 €

MORSETTO

Tipo Won Roll/Redi.

BL13800025



BL3



Cod.	mm	Conf.	Prezzo
PI380017	Ø 40x26/30/32	50	0,61 €

MORSETTO

Tipo Won Roll/Redi.

BL13800030



BL3



Cod.	mm	Conf.	Prezzo
PI380019	Ø 50x26	50	1,98 €

MORSETTO

Tipo Won Roll/Redi.

BL13800033



BL3



Cod.	mm	Conf.	Prezzo
PI380021	Ø 50x26/30/32	50	1,27 €

MORSETTO

Tipo Won Roll/Redi.

BL13800035



BL4



Cod.	mm	Conf.	Prezzo
PI380022	Ø 50x40	50	0,76 €

PROLUNGA IN GOMMA BIANCA

Per scarico WC.

BL16200090



CART GRANDE



Cod.	mm	Conf.	Prezzo
PI550090	Ø 110	24	1,90 €

**PROLUNGA ECCENTRICA
IN GOMMA BIANCA**

Per scarico WC.

BL16600030



CART GRANDE

Cod.	mm	Conf.	Prezzo
PI550095	Ø 110	24	1,90 €

**GUARNIZIONE SCODELLINO
PER GALLEGGIANTI**

BL12200195
BL12200200



BL1

Cod.	mm	Sc	Conf.	Prezzo
PI380040	Ø 19	100	1	6,90 €
PI380044	Ø 29	100	1	27,90 €

GUARNIZIONE DI FONDO

Tipo Pucci (non originale).

BL13800040



BL4

Cod.	Descrizione	Conf.	Prezzo
PI380030	tipo Pucci (non originale)	50	1,42 €

SET GUARNIZIONI DI RICAMBIO

BL13800045



BL4

Cod.	Descrizione	Conf.	Prezzo
PI380032	tipo Pucci (non originale)	10	3,57 €

**GALLEGGIANTE UNIVERSALE
A SCATOLA**

Attacco in ottone.

BL17800215

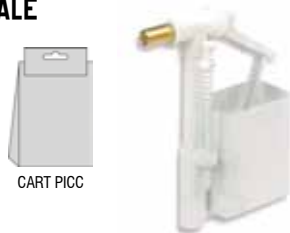

CART PICC

Cod.	Attacco	Conf.	Prezzo
PI460305	3/8	10	8,91 €

INFILZA RICAMBIO MOD. STIR BLITZ

BL14600025



PLAC



Cod.	lit	Conf.	Prezzo
PI460210	12	10	9,83 €

INFILZA RICAMBIO MOD. DORA

BL14600030
BL14600035
BL14600040



PLAC



Cod.	lit	Conf.	Prezzo
PI460213	12	10	8,30 €
PI460214	14 (tipo vecchio)	10	8,30 €
PI460215	14 (tipo vecchio)	10	8,16 €

SFERA IN PARA

Foro passante Ø 15 mm.
Tipo vecchio.

BL14600015
BL14600020



BL5



Cod.	Descrizione	Ø mm	Conf.	Prezzo
PI460101	Dora	58	10	2,44 €
PI460104	Star Blitz	57	10	2,34 €

GALLEGGIANTE PESANTE SILENZIOSO

Barra in ottone.
Sede in inox.

BL14600005



PLAC



Cod.	Attacco	Conf.	Prezzo
PI460000	3/8	50	11,80 €

SFERA PLASTICA PIATTA

Con nottolino in ottone.

BL14600010



CART PICC



Cod.	Ø mm	Conf.	Prezzo
PI460010	90	100	1,11 €

**RUBINETTO A SFERA A SQUADRA NICHELATO
PER CASSETTE DI SCARICO**



BL11800099



BL8



Cod.	Misura	Conf.	Prezzo
2106025500	½" x ½"	48	6,88 €

CASSETTA ESTERNA WC A ZAINO PLUS 1



Senza rubinetto.

-  Cassetta superpiatta di buona qualità, 9 lt, completa di tutti gli accessori con galleggiante a scatola compatto.
-  Applicazione a parete in posizione bassa a zaino. Kit di fissaggio compreso.
-  Allacciamento alla rete idrica: destro, sinistro e posteriore (a richiesta).
-  Rivestimento interno isolante antitrasudazione.
-  Tasto economizzatore d'acqua start/stop.



Cod.	Descrizione	Conf.	Prezzo
PI460400	con antitrasudamento	5	46,10 €

PULSANTE RICAMBIO PER CASSETTA WC PLUS

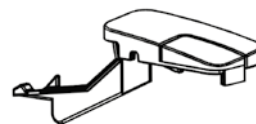

Cod.	Descrizione	Conf.	Prezzo
142627	doppio pulsante	1	5,22 €

GUARNIZIONE PIANA PER CASSETTA WC PLUS



Cod.	mm	Conf.	Prezzo
142618	63x30x3,2	1	2,02 €

CASSETTA ESTERNA WC A ZAINO PLUS 2



Senza rubinetto.

-  Cassetta superpiatta di buona qualità, 9 lt, completa di tutti gli accessori con galleggiante a scatola compatto.
-  Applicazione a parete in posizione bassa a zaino. Kit di fissaggio compreso.
-  Allacciamento alla rete idrica: destro, sinistro e posteriore.
-  Rivestimento interno isolante antitrasudazione.
-  Doppio tasto economizzatore da 3 a 9 lt regolabili.



Cod.	Descrizione	Conf.	Prezzo
PI460405	con antitrasudamento	5	59,90 €

GUARNIZIONE PIANA PER CASSETTA WC PLUS



Cod.	mm	Conf.	Prezzo
142628	75x58x2,4	1	1,27 €

GHIERA FISSA MECCANISMO PER CASSETTA WC PLUS



Cod.	Descrizione	Conf.	Prezzo
142629	per fissaggio meccanismo	1	1,86 €

GALLEGGIANTE BLUE RAMBO PER CASSETTA WC PLUS

Rubinetto a galleggiante universale compatto, riempimento rapido, preciso e silenzioso, massima regolazione del livello d'acqua con sistema antisfonaggio sottoposto a test di controllo non teme acque particolarmente sporche.



Cod.	Descrizione	Conf.	Prezzo
143817	universale	1	14,30 €

GHIERA FILETTATA SCARICO PER CASSETTA WC PLUS



Cod.	Tubo Ø mm	Conf.	Prezzo
142619	50	1	2,69 €

PULSANTE RICAMBIO PER CASSETTA WC PLUS



Cod.	Descrizione	Conf.	Prezzo
142626	un pulsante	1	3,48 €

TUBO DI SCARICO PER CASSETTA A ZAINO



Cod.	mm	cm	Conf.	Prezzo
PI460500	32x50	35	1	5,54 €
PI460505	32x50	80	1	14,75 €
PI460510	32x50	100	1	16,60 €

SEDILE WC UNIVERSALE

In moplen bianco leggero.



Cod.	Descrizione	Conf.	Prezzo
PI820015	universale	1	8,60 €

SEDILE BIANCO WC K2 CLASSIC

Sedile WC universale termoplastico in resina infrangibile con maniglia per sollevamento coperchio. Fissaggio rapido e sicuro con cerniera Uniblock a quattro regolazioni e viti in resina.



Cod.	Descrizione	Conf.	Prezzo
143025	bianco	1	18,65 €

SEDILE WC IN LEGNO LACCATO



Cod.	Descrizione	Conf.	Prezzo
RB9500	in legno laccato	1	25,10 €

SEDILE BIANCO WC EVEREST

Sedile WC universale in termoidurente. Completo di cerniere inox regolabili e viti di fissaggio.



Cod.	Descrizione	Conf.	Prezzo
143026	bianco	1	33,20 €

COPRIWATER UNIVERSALE



Cod.	Descrizione	Conf.	Prezzo
063805	universale	8	35,60 €

SEDILE WC TINTA LEGNO

Universale.



Cod.	Descrizione	Conf.	Prezzo
059792	faggio	1	18,25 €
059795	acero	1	18,25 €

COPRIWATER UNIVERSALE

Antibatterico in termoidurente.



Cod.	cm	Colore	Conf.	Prezzo
68910057	36x43	bianco	8	26,75 €

RIALZO PER WC UNIVERSALE

In polietilene. Adatto per vasi universali.



Cod.	Colore	Conf.	Prezzo
68910055	bianco	3	71,20 €

MANIGLIONE PER BAGNO

In abs bianco.



Cod.	cm	Colore	Conf.	Prezzo
68910062	55	bianco	20	19,90 €
68910064	70	bianco	20	21,85 €

CERNIERE OTTONE CROMATO

Per sedili in legno.

BL18200080



Cod.	Descrizione	Conf.	Prezzo
PI380008	con viti	10	12,30 €

COPPIA SUPPORTI UNIVERSALI

Completi con viti nylon per coprivaso in plastica.

BL18200005



Cod.	Descrizione	Conf.	Prezzo
PI820000	universali	25	0,64 €

RICAMBIO CERNIERA IN BUSTA PER RB9500

Con accessori.



Cod.	Pz	Conf.	Prezzo
R00328	2	1	7,49 €

COPPIA SUPPORTI UNIVERSALI

Con viti in ottone per coprivaso in plastica.

BL18200010



Cod.	Descrizione	Conf.	Prezzo
PI820005	universali	25	1,14 €

ROLLINO PORTACARTA

BL12200175



Cod.	Descrizione	Conf.	Prezzo
PI220170	bianco	50	0,45 €

SUPPORTO PER WC

Con viti in ottone per coprivaso in plastica.

BL18200015



Cod.	Tipo	Conf.	Prezzo
841296	zama s.s.	10	5,41 €

KIT PARACOLPI PER SEDILI

In plastica.

BL18200025



Cod.	Descrizione	Conf.	Prezzo
PI820020	in plastica	25	1,29 €

CERNIERE WC UNIVERSALI

Con accessori.



Cod.	Descrizione	Conf.	Prezzo
841266	universali	10	5,42 €

KIT PARACOLPI UNIVERSALI

Per coprivaso in plastica.

BL18200030



Cod.	Descrizione	Conf.	Prezzo
PI820025	universali	25	1,81 €

KIT PARACOLPI UNIVERSALI A CHIUDO

Per coprivaso
in legno.

BL18200035



BL6



Cod.	Descrizione	Conf.	Prezzo
PI820030	universali	25	2,21 €

KIT PARACOLPI UNIVERSALI AD INNESTO

Per coprivaso
in legno.

BL18200040



BL6



Cod.	Descrizione	Conf.	Prezzo
PI820035	universali	25	1,80 €

RICAMBIO SCOPINO

Con manico e
fiocco in setola.

BL18600005



PLAC



Cod.	Descrizione	Conf.	Prezzo
PI860000	fiocco in setola	5	2,02 €

RICAMBIO SCOPINO HANDY

Con manico e
fiocco in setola.



Cod.	Descrizione	Conf.	Prezzo
054152	fiocco in setola	5	1,27 €

PORTASCOPINO WC CON SUPPORTO A MURO CROMATO



Cod.	Descrizione	Conf.	Prezzo
RB3100	vaso in ceramica	1	5,17 €

PORTASCOPINO PONG



In plastica.



Cod.	Colore	Conf.	Prezzo
68910000	bianco	24	5,40 €

PORTASCOPINO AD ANGOLO HANDY

In plastica.



Cod.	Colore	Conf.	Prezzo
003580	bianco	12	4,78 €

PORTASCOPINO A PARETE



In cromo/vetro satinato con piastrine in
acciaio antiruggine.



Cod.	Descrizione	Conf.	Prezzo
68910029	in cromo/vetro	6	19,05 €

PORTASCOPINO



In abs cromo.



Cod.	cm	Conf.	Prezzo
68910002	38	24	9,18 €

APPENDINI SET

In abs bianco con doppio fissaggio tasselli o biadesivo.



Cod.	Colore	Pz	Conf.	Prezzo
68910016	bianco	2	18	3,36 €

PORTASAPONE

In abs bianco con doppio fissaggio tasselli o biadesivo.



Cod.	Colore	Conf.	Prezzo
68910018	bianco	12	4,20 €

APPENDINO

In cromo con piastrine in acciaio antiruggine.



Cod.	Descrizione	Conf.	Prezzo
68910024	in cromo	12	8,40 €

PORTASAPONE

In cromo/vetro satinato con piastrine in acciaio antiruggine.



Cod.	Descrizione	Conf.	Prezzo
68910026	in cromo/vetro	6	14,00 €

PORTASPAZZOLINO

in abs bianco con doppio fissaggio tasselli o biadesivo.



Cod.	Colore	Conf.	Prezzo
68910017	bianco	12	7,56 €

PORTAROTOLO

In abs bianco con doppio fissaggio tasselli o biadesivo.



Cod.	Colore	Conf.	Prezzo
68910019	bianco	12	4,20 €

PORTASPAZZOLINO

In cromo/vetro satinato con piastrine in acciaio antiruggine.



Cod.	Descrizione	Conf.	Prezzo
68910025	in cromo/vetro	6	12,90 €

PORTAROTOLO

In cromo con piastrine in acciaio antiruggine.



Cod.	Descrizione	Conf.	Prezzo
68910028	in cromo	24	15,15 €

PORTADISPENSER

In cromo/vetro satinato con piastrine in acciaio antiruggine.



Cod.	Descrizione	Conf.	Prezzo
68910027	in cromo/vetro	6	16,80 €

PORTASCIUGAMANI

In abs bianco con doppio fissaggio tassello biadesivo.



Cod.	cm	Colore	Conf.	Prezzo
68910014	30	bianco	12	6,86 €
68910015	50	bianco	12	9,52 €

PORTASCIUGAMANI



In cromo con piastrelle in acciaio antiruggine.



Cod.	cm	Descrizione	Conf.	Prezzo
68910022	40	in cromo	6	17,40 €
68910021	60	in cromo	6	20,45 €

MENSOLA



In abs bianco con doppio fissaggio tasselli o biadesivo.



Cod.	cm	Colore	Conf.	Prezzo
68910012	23	bianco	12	6,58 €

MENSOLA



In abs bianco con doppio fissaggio tasselli o biadesivo.



Cod.	cm	Colore	Conf.	Prezzo
68910013	50	bianco	12	11,50 €

MENSOLA RETTANGOLARE



In cromo/vetro satinato con piastrelle in acciaio antiruggine.



Cod.	cm	Descrizione	Conf.	Prezzo
68910020	50	in cromo/vetro	6	32,80 €

PATTUMIERA



In acciaio cromato.



Cod.	Capacità lt	Conf.	Prezzo
68910004	3	6	18,80 €
68910005	5	6	24,60 €

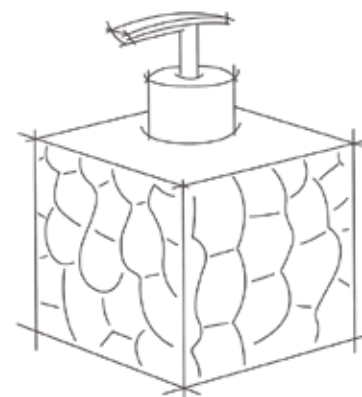
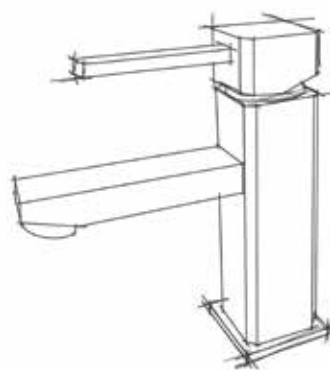

MENSOLA RETTANGOLARE UN RIPIANO

Con trattamento antipolvere e antiruggine.



Cod.	cm	Conf.	Prezzo
68910010	26x11xh11	24	8,68 €

MENSOLA ANGOLARE UN RIPIANO

Con trattamento antipolvere e antiruggine.

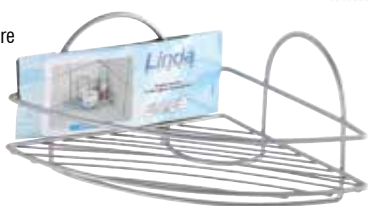

Cod.	cm	Conf.	Prezzo
68910007	22x22xh11	12	11,50 €

MENSOLA ANGOLARE DUE RIPIANI

Con trattamento antipolvere e antiruggine.



Cod.	cm	Conf.	Prezzo
68910008	22x22xh36,5	6	26,60 €

MENSOLA ANGOLARE TRE RIPIANI

Con trattamento antipolvere e antiruggine.



Cod.	cm	Conf.	Prezzo
68910009	22x22xh53	4	38,70 €

TENDA DOCCIA

In vinile.



Cod.	cm	Colore	Conf.	Prezzo
68910030	120x200	grigio	24	8,68 €
68910031	180x200	grigio	24	10,95 €
68910032	240x200	grigio	24	13,20 €

TENDA DOCCIA

In vinile.



Cod.	cm	Colore	Conf.	Prezzo
68910033	120x200	blu	24	8,68 €
68910034	180x200	blu	24	10,95 €
68910035	240x200	blu	24	13,20 €

TENDA DOCCIA

In poliestere.



Cod.	cm	Colore	Conf.	Prezzo
68910038	120x200	grigio/blu	24	11,80 €
68910039	180x200	grigio/blu	24	14,30 €
68910040	200x240	grigio/blu	24	17,65 €

TENDA DOCCIA

In poliestere.



Cod.	cm	Colore	Conf.	Prezzo
68910041	120x200	color mix	24	8,91 €
68910042	180x200	color mix	24	10,40 €
68910043	240x200	color mix	24	11,90 €

ASTA TENDA DRITTA

fendras

In cromo.



Misure in cm:

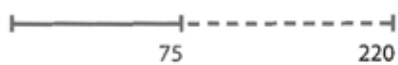

Cod.	Ø mm	cm	Conf.	Prezzo
68910045	22	75/125	10	14,35 €
68910046	22	75/220	10	19,45 €

ASTA TENDA ANGOLARE

fendras

In cromo.



Misure in cm:



Cod.	Ø mm	cm	Conf.	Prezzo
68910047	22	90x90	10	20,80 €

ASTA TENDA ANGOLARE

fendras

In cromo.



Misure in cm:

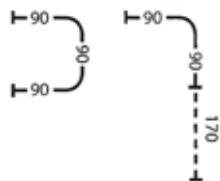

Cod.	Ø mm	cm	Conf.	Prezzo
68910048	22	90x170	10	26,20 €

SET GANCI DOCCIA

fendras

Trasparenti.



Cod.	Pz	Conf.	Prezzo
68910050	12	24	2,24 €

RUBINETTO A SFERA PER LAVATRICI CROMATO

FIV L.L.

Con rosone.



Cod.	Misura	Conf.	Prezzo
2106015500	1/2" x 1/2"	24	7,60 €
2106015600	1/2" x 3/4"	24	7,95 €

RUBINETTO LAVATRICE

A SFERA A SQUADRA

Cromato con rosetta. Maglia in ABS.

BL11800025



Cod.	Attacco	Conf.	Prezzo
RB5080	1/2 x 3/4	10	5,69 €

RUBINETTO A VITONE SEMPLICE A SQUADRA PER LAVATRICE

Maniglia in ABS.

BL11800010
BL11800015



Cod.	Attacco	Conf.	Prezzo
PI180000	3/8	10	10,60 €
PI180002	1/2	10	14,00 €

RUBINETTO A VITONE 3 VIE PER LAVATRICE

Maniglia in ABS.

BL11800020



Cod.	Attacco	Conf.	Prezzo
PI180005	1/2x1/2x3/4	10	8,53 €

RUBINETTO SOTTOLAVABO + LAVATRICE



Cod.	mm	Conf.	Prezzo
PI150000	1/2"x10	2	19,20 €

RUBINETTO A VITONE DUPLEX PER LAVATRICE

Maniglia in ABS.



Cod.	Attacco	Conf.	Prezzo
PI180015	1/2 x 3/4	12	18,70 €

TUBO CARICO LAVATRICE FF

Curva per passaggio acqua fino a 25°C. Gomma in PVC interna con inserti in nylon. Guarnizioni da richiedere a parte.



Cod.	Attacco	cm	Conf.	Prezzo
PI180050	F3/4 x F3/4	150	25	3,05 €
PI180052	F3/4 x F3/4	200	25	3,37 €
PI180054	F3/4 x F3/4	250	25	3,76 €

TUBO SCARICO LAVATRICE MILLE RIGHE

Con manicotti Ø 19x21 mm completi di curva.



Cod.	cm	Conf.	Prezzo
PI180020	150	10	1,91 €
PI180025	200	10	2,40 €
PI180030	250	10	2,74 €

TUBO SCARICO LAVATRICE ESTENSIBILE

Con manicotto Ø21x22 mm.



Cod.	cm	Conf.	Prezzo
PI180040	da 90 a 300	10	2,92 €

NIPPLE PLASTICA PER TUBI CARICO LAVATRICE

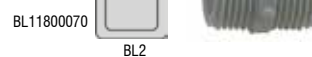

Cod.	Attacco	Conf.	Prezzo
PI180065	3/4	20	0,22 €

CURVA PER SCARICO LAVATRICE

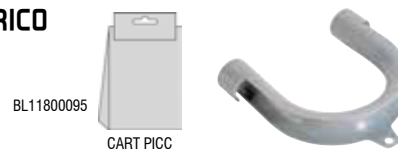

Cod.	Descrizione	Pz	Conf.	Prezzo
PI180046	plastica	10	1	0,27 €

GIUNTO A 2 VIE PER TUBO CARICO LAVATRICE



Cod.	Attacco	Conf.	Prezzo
PI180070	3/4	20	1,47 €

GIUNTO PLASTICA NERO DIRITTO PER TUBO SCARICO LAVATRICE

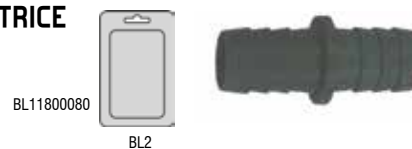

Cod.	Ø mm	Conf.	Prezzo
PI180075	20x20	20	0,27 €

GIUNTO A 3 VIE PER TUBO SCARICO LAVATRICE



Cod.	Ø mm	Conf.	Prezzo
PI180080	20x20x20	20	0,84 €

GUARNIZIONE PER TUBO CARICO LAVATRICE



Cod.	Attacco	Pz	Conf.	Prezzo
PI180060	3/4	100	1	3,24 €

VALVOLA SFOGO ARIA

Per radiatore in ottone pesante sbiancato.

BL15800035



BL1



Cod.	Attacco	Conf.	Prezzo
PI580010	1/4	100	1,69 €

VOLANTINO RICAMBIO PER VALVOLE RADIATORI

BL15800040



BL5



Cod.	Attacco	Conf.	Prezzo
PI580090	universale	10	1,43 €

ANTICALCARE PER DOSATORI POLVERE POLIFOS

Prodotto anticalcare e anticorrosivo in polvere da miscelare con acqua potabile per dosatori proporzionali.



Cod.	kg	Conf.	Prezzo
PI900035	1	12	12,40 €

TUBO ACQUA MULTISTRATO RIVESTITO

Realizzato combinando uno strato di alluminio all'interno di due strati di polietilene.



Cod.	mm	m	Prezzo
063691	16x2	1	2,01 €
063692	20x2	1	2,55 €

RACCORDO MULTISTRATO DIRITTO



Cod.	Ø	Misura	Conf.	Prezzo
2183501612	1/2"	M16	10	2,58 €
2183502034	3/4"	M20	10	4,52 €

RACCORDO MULTISTRATO DIRITTO



Cod.	Ø	Misura	Conf.	Prezzo
2183511612	1/2"	F16	10	2,82 €
2183512034	3/4"	F20	10	4,91 €

RACCORDO MULTISTRATO DIRITTO DOPPIO



Cod.	Ø	Conf.	Prezzo
2183521616	16x16	10	4,46 €
2183522020	20x20	10	7,45 €

RACCORDO MULTISTRATO TEE



Cod.	Ø	Conf.	Prezzo
2183531616	16x16x16	10	6,94 €
2183532020	20x20x20	10	11,40 €

RACCORDO MULTISTRATO TEE



Cod.	Ø	Conf.	Prezzo
2183541216	F16x1/2"x16	10	6,21 €
2183541220	F20x1/2"x20	10	9,25 €

RACCORDO MULTISTRATO CURVO



Cod.	Ø	Misura	Conf.	Prezzo
2183551612	1/2"	F16	10	4,06 €
2183552034	3/4"	F20	10	6,21 €

RACCORDO MULTISTRATO CURVO DOPPIO



Cod.	Ø	Misura	Conf.	Prezzo
2183561616	16	F16	10	4,97 €
2183562020	20	F20	10	7,79 €

RACCORDO MULTISTRATO CURVO + FLANGIA



Cod.	Ø	Misura	Conf.	Prezzo
2183571612	1/2"	F16	10	4,79 €
2183572012	1/2"	F20	10	7,11 €

RACCORDO MULTISTRATO CURVO



Cod.	Ø	Misura	Conf.	Prezzo
2183581612	1/2"	M16	10	3,73 €
2183582034	3/4"	M20	10	5,70 €

GOMITO A 90° FF

In ottone cromato.

BL16200080 (1/2")
BL16200085 (3/4")



BL2/BL3

Cod.	Ø	Conf.	Prezzo
PI540065	3/8"	10	3,39 €
PI540070	1/2"	10	3,81 €
PI540075	3/4"	10	6,35 €

TEE FFF

In ottone cromato.

BL16200030 (1/2")
BL16200035 (3/4")



BL2/BL3

Cod.	Ø	Conf.	Prezzo
PI540088	3/8"	10	3,78 €
PI540090	1/2"	10	4,39 €
PI540095	3/4"	10	6,35 €

DADO ESAGONALE

In ottone cromato.

BL11800185
BL11800190



BL1

Cod.	Ø	Conf.	Prezzo
PI180085	1"	20	1,95 €
PI180090	1" x 1/4"	20	2,10 €

MANICOTTO FF

In ottone cromato.

BL16200075 (1/2")
BL16200040 (3/4")

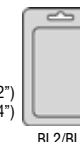

BL2/BL3

Cod.	Ø	Conf.	Prezzo
PI540110	3/8"	10	2,13 €
PI540115	1/2"	10	2,81 €
PI540120	3/4"	10	3,27 €

TAPPO ESAGONALE

M E F

In ottone cromato.

BL16200010 (M 1/2")
BL16200015 (M 3/4")
BL16200020 (F 1/2")
BL16200025 (F 3/4")

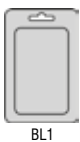

BL1

Cod.	Ø	Conf.	Prezzo
PI540005	M 3/8"	10	1,25 €
PI540010	M 1/2"	10	1,65 €
PI540015	M 3/4"	10	2,40 €
PI540025	F 3/8"	10	1,08 €
PI540030	F 1/2"	10	1,37 €
PI540035	F 3/4"	10	1,78 €

VITE DOPPIA ESAGONALE MM

In ottone cromato.

BL21081550 (1/2")
BL16200045 (3/4")

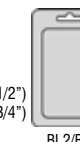

BL2/BL3

Cod.	Ø	Conf.	Prezzo
PI540130	3/8"	10	1,36 €
PI540135	1/2"	10	1,92 €
PI540140	3/4"	10	2,29 €

GOMITO A 90° MF

In ottone cromato.

BL16200070 (1/2")
BL16200072 (3/4")



BL2/BL3

Cod.	Ø	Conf.	Prezzo
PI540045	3/8"	10	2,99 €
PI540050	1/2"	10	3,39 €
PI540055	3/4"	10	5,02 €

MANICOTTO RIDOTTO FF - FIG. 240

In acciaio zincato.

BL21240430
BL21240530
BL21240540
BL21240650
BL21240760



BL1/BL2/BL5

Cod.	Ø	Conf.	Prezzo
2112404300	3/8"x1/4"	10	0,96 €
2112405300	1/2"x1/4"	10	1,31 €
2112405400	1/2"x3/8"	10	1,27 €
2112406500	3/4"x1/2"	10	1,64 €
2112407600	1"x3/4"	10	2,88 €

RIDUZIONE MF - FIG. 241

In acciaio zincato.

BL21241430
BL21241530
BL21241540
BL21241650
BL21241750
BL21241760

BL1/BL2/BL4



Cod.	Ø	Conf.	Prezzo
2112414200	1/4"x1/8"	10	0,94 €
2112414300	3/8"x1/4"	10	0,59 €
2112415300	1/2"x1/4"	10	0,68 €
2112415400	1/2"x3/8"	10	0,60 €
2112415500	3/4"x3/8"	10	0,94 €
2112416500	3/4"x1/2"	10	0,90 €
2112417500	1"x1/2"	10	1,94 €
2112417600	1"x3/4"	10	1,85 €

NIPPLES DI RIDUZIONE - FIG. 245

In acciaio zincato.

BL21245430
BL21245530
BL21245540
BL21245650
BL21245760

BL1/BL2/BL5



Cod.	Ø	Conf.	Prezzo
2112455200	1/4"x1/8"	10	1,26 €
2112454300	3/8"x1/4"	10	0,75 €
2112455300	1/2"x1/4"	10	1,09 €
2112455400	1/2"x3/8"	10	0,90 €
2112456500	3/4"x1/2"	10	1,55 €
2112457600	1"x3/4"	10	2,79 €

PROLUNGA RIDOTTA MF - FIG. 246

In acciaio zincato.

BL21246340
BL21246450
BL21246560
BL21246670

BL1/BL2/BL4/BL5



Cod.	Ø x mm	Conf.	Prezzo
2112463400	1/4"x3/8"x15	10	0,92 €
2112464500	3/8"x1/2"x15	10	0,78 €
2112465600	1/2"x3/4"x15	10	1,37 €
2112466700	3/4"x1"x15	10	2,26 €
2112467800	1"x1 1/4"x20	10	16,30 €

NIPPLES DOPPIA VITE - FIG. 280

In acciaio zincato.

BL21280030
BL21280040
BL21280050
BL21280060
BL21280070

BL1/BL2/BL3/BL5



Cod.	Ø	Conf.	Prezzo
2112800300	1/4"	10	0,66 €
2112800400	3/8"	10	0,70 €
2112800500	1/2"	10	0,81 €
2112800600	3/4"	10	1,09 €
2112800700	1"	10	2,43 €

TAPPO MASCHIO CON QUADRO - FIG. 290

In acciaio zincato.

BL21290030
BL21290040
BL21290050
BL21290060
BL21290070

BL1/BL2/BL3/BL4



Cod.	Ø	Conf.	Prezzo
2112900300	1/4"	10	0,50 €
2112900400	3/8"	10	0,55 €
2112900500	1/2"	10	0,52 €
2112900600	3/4"	10	0,90 €
2112900700	1"	10	2,00 €

TAPPO F - FIG. 300

In acciaio zincato.
2 pz per blister.

BL21300030
BL21300040
BL21300050
BL21300060
BL21300070

BL1/BL2/BL4



Cod.	Ø	Conf.	Prezzo
2113000300	1/4"	10	0,86 €
2113000400	3/8"	10	0,60 €
2113000500	1/2"	10	0,66 €
2113000600	3/4"	10	0,93 €
2113000700	1"	10	3,27 €

PROLUNGA TIPO PESANTE - FIG. 529

In acciaio zincato.

BL21529041
BL21529042
BL21529043
BL21529051
BL21529052
BL21529053
BL21529061
BL21529062
BL21529063

BL1/BL2/BL3



Cod.	Ø x mm	Conf.	Prezzo
2115290410	3/8"x10	10	0,56 €
2115290415	3/8"x15	10	0,60 €
2115290420	3/8"x20	10	0,70 €
2115290510	1/2"x10	10	0,48 €
2115290515	1/2"x1,5	10	0,50 €
2115290520	1/2"x20	10	0,60 €
2115290525	1/2"x25	10	1,06 €
2115290530	1/2"x30	10	1,16 €
2115290610	3/4"x10	10	1,09 €
2115290615	3/4"x15	10	1,25 €
2115290620	3/4"x20	10	1,40 €
2115290630	1"x15	10	3,72 €
2115290635	1"x20	10	3,92 €

NIPPLES CON TUTTO FILETTATO - FIG. 531

In acciaio zincato.

BL21531030
BL21531040
BL21531050
BL21531060
BL21531070

BL1/BL2/BL3



Cod.	Ø	Conf.	Prezzo
2115310300	1/4"	10	0,90 €
2115310400	3/8"	10	0,70 €
2115310500	1/2"	10	0,75 €
2115310600	3/4"	10	1,16 €
2115310700	1"	10	1,85 €

MANICOTTO - FIG. 702

In acciaio zincato.

BL21702030
BL21702040
BL21702050
BL21702060
BL21702070

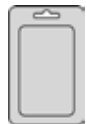

BL1/BL2/BL3/BL5



Cod.	Ø	Conf.	Prezzo
2117020300	1/4"	10	0,81 €
2117020400	3/8"	10	0,81 €
2117020500	1/2"	50	0,90 €
2117020600	3/4"	10	1,20 €
2117020700	1"	10	1,70 €

BARILOTTO IN ACCIAIO ZINCATO

1/2" 3/4"
BL20850510 BL20850610
BL20850515 BL20850615
BL20850520 BL20850620
BL20850525 BL20850625
BL20850550 BL20850650
BL20850500 BL20850600
BL20850505 BL20850605



PLAC



Cod.	Ø	cm	Conf.	Prezzo
2108500510	1/2"	10	10	1,31 €
2108500515	1/2"	15	10	1,82 €
2108500520	1/2"	20	10	2,28 €
2108500525	1/2"	25	10	2,73 €
2108500550	1/2"	50	10	4,85 €
2108500500	1/2"	100	5	8,94 €
2108500505	1/2"	150	5	13,35 €
2108500507	1/2"	200	5	17,40 €

2108500610	3/4"	10	10	1,61 €
2108500615	3/4"	15	10	2,20 €
2108500620	3/4"	20	10	2,67 €
2108500625	3/4"	25	10	3,12 €
2108500650	3/4"	50	10	5,91 €
2108500600	3/4"	100	5	11,25 €
2108500605	3/4"	150	5	15,50 €
2108500607	3/4"	200	5	20,65 €
2108500710	1"	10	10	2,17 €
2108500715	1"	15	10	3,07 €
2108500720	1"	20	10	3,97 €
2108500725	1"	25	10	4,80 €
2108500750	1"	50	10	9,03 €
2108500700	1"	100	5	16,15 €
2108500705	1"	150	5	23,70 €

CURVA FF 90° - FIG 2

In ghisa zincata.



Cod.	Ø	Conf.	Prezzo
2100020500	1/2"	50	2,26 €
2100020600	3/4"	20	3,36 €
2100020700	1"	20	4,81 €
2100020800	1 1/4"	10	7,72 €
2100020900	1 1/2"	10	10,90 €

CURVA SALTATUBI - FIG. 85

In ghisa zincata.



BL24085050

PLAC



Cod.	Ø	Conf.	Prezzo
2100850500	1/2"	20	3,74 €

GOMITO FF 90° - FIG 90

In ghisa zincata.



BL24090050 - 1/2"

BL24090060 - 3/4"

PLAC



Cod.	Ø	Conf.	Prezzo
2100900300	1/4"	10	1,50 €
2100900400	3/8"	30	1,25 €
2100900500	1/2"	100	0,71 €
2100900600	3/4"	50	1,07 €
2100900700	1"	30	1,58 €
2100900800	1 1/4"	10	3,27 €
2100900900	1 1/2"	10	4,75 €
2100901000	2"	10	6,98 €

CURVA MF 90° - FIG 1

In ghisa zincata.



Cod.	Ø	Conf.	Prezzo
2100010500	1/2"	50	2,14 €
2100010600	3/4"	20	2,97 €
2100010700	1"	20	4,40 €
2100010800	1 1/4"	10	7,78 €
2100010900	1 1/2"	10	9,98 €

GOMITO MF 90° - FIG 92

In ghisa zincata.



BL24092050 - 1/2"

BL24092060 - 3/4"

PLAC



Cod.	Ø	Conf.	Prezzo
2100920300	1/4"	10	1,56 €
2100920400	3/8"	30	1,28 €
2100920500	1/2"	100	0,77 €
2100920600	3/4"	50	1,25 €
2100920700	1"	30	2,08 €
2100920800	1 1/4"	10	4,01 €
2100920900	1 1/2"	10	5,50 €
2100921000	2"	10	7,42 €

DISTRIBUZIONE A GOMITO 3 VIE- FIG 221

In ghisa zincata.



Cod.	Ø	Conf.	Prezzo
2102210500	1/2"	50	3,48 €

TEE FF - FIG 130

In ghisa zincata.



Cod.	Ø	Conf.	Prezzo
2101300400	3/8"	30	1,61 €
2101300500	1/2"	100	0,92 €
2101300600	3/4"	50	1,55 €
2101300700	1"	30	2,38 €
2101300800	1 1/4"	10	4,31 €
2101300900	1 1/2"	10	6,24 €
2101301000	2"	5	8,91 €

CROCE F - FIG 180

In ghisa zincata.



Cod.	Ø	Conf.	Prezzo
2101800500	1/2"	50	3,54 €
2101800600	3/4"	20	4,81 €
2101800700	1"	20	6,42 €

MANICOTTO RIDUZIONE - FIG 240

In ghisa zincata.



Cod.	Ø	Conf.	Prezzo
2102405400	1/2" x 3/8"	10	1,19 €
2102406400	3/4" x 3/8"	10	1,49 €
2102406500	3/4" x 1/2"	10	1,49 €
2102407600	1" x 3/4"	10	1,79 €
2102408700	1 1/4" x 1"	10	2,97 €
2102409600	1 1/2" x 3/4"	5	4,46 €
2102401080	2" x 1 1/4"	5	6,83 €
2102401090	2" x 1 1/2"	5	6,53 €

RIDUZIONE MF - FIG 241

In ghisa zincata.



Cod.	Ø	Conf.	Prezzo
2102415400	1/2" x 3/8"	10	0,94 €
2102416500	3/4" x 1/2"	10	1,04 €
2102417500	1" x 1/2"	10	1,46 €
2102417600	1" x 3/4"	10	1,34 €
2102418700	1 1/4" x 1"	10	1,34 €
2102419500	1 1/2" x 1/2"	10	2,50 €
2102419700	1 1/2" x 1"	10	2,14 €
2102419800	1 1/2" x 1 1/4"	10	2,26 €
2102411070	2" x 1"	5	4,52 €
2102411080	2" x 1 1/4"	5	4,16 €
2102411090	2" x 1 1/2"	5	4,16 €

NIPPLES RIDOTTO MM - FIG 245

In ghisa zincata.



Cod.	Ø	Conf.	Prezzo
2102455400	1/2" x 3/8"	10	1,93 €
2102456500	3/4" x 1/2"	10	1,61 €
2102457500	1" x 1/2"	10	2,73 €
2102457600	1" x 3/4"	10	2,17 €
2102458600	1 1/4" x 3/4"	10	4,52 €
2102458700	1 1/4" x 1"	10	3,86 €
2102459800	1 1/2" x 1 1/4"	5	4,52 €

MANICOTTO RIDOTTO FM - FIG 246

In ghisa zincata.



Cod.	Ø	Conf.	Prezzo
2102465400	1/2" x 3/8"	50	2,20 €
2102466500	3/4" x 1/2"	30	2,85 €
2102467600	1" x 3/4"	20	3,95 €
2102468700	1 1/4" x 1"	10	5,67 €
2102469800	1 1/2" x 1 1/4"	5	6,86 €

MANICOTTO - FIG 270

In ghisa zincata.

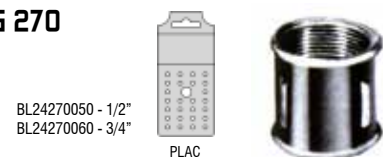

Cod.	Ø	Conf.	Prezzo
2102700400	3/8"	30	1,46 €
2102700500	1/2"	100	0,94 €
2102700600	3/4"	50	1,22 €
2102700700	1"	20	1,93 €
2102700800	1 1/4"	10	2,88 €
2102700900	1 1/2"	10	3,54 €
2102701000	2"	5	5,46 €

TAPPO M - FIG 290

In ghisa zincata.



Cod.	Ø	Conf.	Prezzo
2102900400	3/8"	30	0,71 €
2102900500	1/2"	100	0,56 €
2102900600	3/4"	50	0,74 €
2102900700	1"	20	0,92 €
2102900800	1 1/4"	10	1,75 €
2102900900	1 1/2"	10	2,08 €
2102901000	2"	5	3,27 €

GOMITO RIDOTTO FF - FIG 90R

In ghisa zincata.



Cod.	Ø	Conf.	Prezzo
21090R5400	1/2" x 3/8"	10	1,63 €
21090R6500	3/4" x 1/2"	10	1,93 €

CALOTTA - FIG 300

In ghisa zincata.



Cod.	Ø	Conf.	Prezzo
2103000400	3/8"	30	0,94 €
2103000500	1/2"	100	0,89 €
2103000600	3/4"	50	1,04 €
2103000700	1"	20	1,55 €
2103000800	1 1/4"	10	2,26 €
2103000900	1 1/2"	10	2,91 €
2103001000	2"	5	4,01 €

NIPPLES - FIG 280

In ghisa zincata.



Cod.	Ø	Conf.	Prezzo
2102800400	3/8"	30	1,19 €
2102800500	1/2"	100	0,74 €
2102800600	3/4"	50	0,92 €
2102800700	1"	20	1,31 €
2102800800	1 1/4"	10	2,44 €
2102800900	1 1/2"	10	2,97 €
2102801000	2"	5	4,60 €

CONTRODADO - FIG 310

In ghisa zincata.



Cod.	Ø	Conf.	Prezzo
2103100500	1/2"	100	0,83 €
2103100600	3/4"	100	0,87 €
2103100700	1"	50	1,29 €
2103100800	1 1/4"	20	1,87 €
2103100900	1 1/2"	10	2,14 €

BOCCHETTONE PIANO FF - FIG 330

In ghisa zincata.



Cod.	Ø	Conf.	Prezzo
2103300500	1/2"	20	3,54 €
2103300600	3/4"	20	4,52 €
2103300700	1"	20	5,14 €
2103300800	1 1/4"	10	7,72 €
2103300900	1 1/2"	10	10,70 €

BOCCHETTONE PIANO MF - FIG 331

In ghisa zincata.



Cod.	Ø	Conf.	Prezzo
2103310500	1/2"	20	4,52 €
2103310600	3/4"	20	5,14 €
2103310700	1"	10	6,74 €
2103310800	1 1/4"	10	9,95 €
2103310900	1 1/2"	5	12,85 €

BOCCHETTONE CONICO FF - FIG 340

In ghisa zincata.



Cod.	Ø	Conf.	Prezzo
2103400500	1/2"	100	4,31 €
2103400600	3/4"	50	5,50 €
2103400700	1"	20	6,53 €
2103400800	1 1/4"	10	8,91 €
2103400900	1 1/2"	10	11,60 €
2103401000	2"	10	21,00 €

BOCCHETTONE CONICO MF - FIG 341

In ghisa zincata.



Cod.	Ø	Conf.	Prezzo
2103410500	1/2"	10	4,60 €
2103410600	3/4"	20	5,05 €
2103410700	1"	10	5,64 €
2103410800	1 1/4"	10	9,21 €
2103410900	1 1/2"	10	13,10 €
2103411000	2"	10	19,30 €

MANICOTTO MF - FIG 529

In ghisa zincata.



Cod.	Ø	Conf.	Prezzo
2102710500	1/2"	10	2,28 €
2102710600	3/4"	10	2,67 €
2102710700	1"	10	3,40 €

GOMITO 90° FF - AISI 316

Inox.



Cod.	Ø	Conf.	Prezzo
2400900500	1/2"	10	2,80 €
2400900600	3/4"	10	4,52 €
2400900700	1"	10	6,43 €

GOMITO AISI 316 MF - FIG 92

Inox.



Cod.	Ø	Conf.	Prezzo
2400920500	1/2"	10	3,50 €
2400920600	3/4"	10	4,74 €
2400920700	1"	10	7,34 €

MANICOTTO AISI 316 F - FIG 270

Inox.



Cod.	Ø	Conf.	Prezzo
2402700500	1/2"	10	2,49 €
2402700600	3/4"	10	2,94 €
2402700700	1"	10	4,29 €

NIPPLES AISI 316 - FIG 280

Inox.



Cod.	Ø	Conf.	Prezzo
2402800500	1/2"	10	2,49 €
2402800600	3/4"	10	3,61 €
2402800700	1"	10	5,36 €

TEE AISI 316 - FIG 130

Inox.



Cod.	Ø	Conf.	Prezzo
2401300500	1/2"	10	4,00 €
2401300600	3/4"	10	6,25 €
2401300700	1"	10	8,69 €

TAPPO AISI 316 M - FIG 290

Inox.



Cod.	Ø	Conf.	Prezzo
2402900500	1/2"	10	1,94 €
2402900600	3/4"	10	2,80 €
2402900700	1"	10	4,27 €

TAPPO AISI 316 F - FIG 300

Inox.



Cod.	Ø	Conf.	Prezzo
2403000500	1/2"	10	2,54 €
2403000600	3/4"	10	3,56 €
2403000700	1"	10	5,40 €

RACCORDO PER TUBO POLIETILENE M

In ottone giallo.



Cod.	Ø	Conf.	Prezzo
2121800500	1/2"	10	4,29 €
2121800600	3/4"	10	7,11 €
2121800700	1"	10	10,50 €
2121800800	1" 1/4"	1	16,40 €
2121800900	1" 1/2"	1	23,05 €

RACCORDO DIRITTO PER VASO

In ottone giallo.



Cod.	Ø	Conf.	Prezzo
2121950500	1/2"	20	9,59 €
2121950600	3/4"	15	12,45 €
2121950700	1"	10	17,50 €

PILETTA PER CASSONI

In ottone giallo.



Cod.	Ø	Conf.	Prezzo
2121960500	1/2"	20	7,67 €
2121960600	3/4"	20	10,40 €
2121960700	1"	10	13,00 €

GOMITO FLANGIATO FF

In ottone giallo.



Cod.	Ø	Conf.	Prezzo
2120910500	1/2"	10	3,87 €

RACCORDO PER TUBO POLIETILENE F

In ottone giallo.



Cod.	Ø	Conf.	Prezzo
2121820500	1/2"	10	4,29 €
2121820600	3/4"	10	7,67 €
2121820700	1"	10	9,65 €
2121820800	1"1/4	1	18,20 €
2121820900	1"1/2	1	24,95 €

MANICOTTO PER TUBO POLIURETANO FF

In ottone giallo.



Cod.	Ø	Conf.	Prezzo
2121842020	20x20	10	6,66 €
2121842525	25x25	10	12,00 €
2121843232	32x32	10	17,50 €
2121844040	40x40	1	25,65 €

RACCORDO A TEE CON DERIVAZIONE F PER TUBO POLIETILENE

In ottone giallo.



Cod.	Ø	Conf.	Prezzo
2121860500	1/2"	10	8,18 €
2121860600	3/4"	10	15,95 €
2121860700	1"	10	21,45 €
2121860800	1"1/4	1	37,00 €
2121860900	1"1/2	1	54,20 €

RACCORDO TEE PER TUBO POLIETILENE

In ottone giallo.



Cod.	Ø	Conf.	Prezzo
2121882020	20x20x20	10	11,85 €
2121882525	25x25x25	10	22,90 €
2121883232	32x32x32	10	25,75 €

GOMITO PER TUBO POLIETILENE

In ottone giallo.



Cod.	Ø	Conf.	Prezzo
2121902020	20x20	10	8,24 €
2121902525	25x25	10	13,90 €
2121903232	32x32	10	22,00 €
2121904040	40x40	1	31,10 €

GOMITO FF PER TUBO POLIETILENE

In ottone giallo.



Cod.	Ø	Conf.	Prezzo
2121920500	20x1/2"	10	5,87 €
2121920600	25x3/4"	10	8,97 €
2121920700	32x1"	10	12,65 €
2121920800	40x1"1/4	1	24,70 €

GOMITO MF PER TUBO POLIETILENE

In ottone giallo.



Cod.	Ø	Conf.	Prezzo
2121940500	20x1/2"	10	5,87 €
2121940600	25x3/4"	10	10,20 €
2121940700	32x1"	10	13,80 €
2121940800	40x1"1/4	1	24,85 €

**BOCCHETTONE PIANO DIRITTO
MASCHIO-FEMMINA 3 PZ**

In ottone giallo.



Cod.	Ø mm	Pz	Conf.	Prezzo
2153310500	1/2"	1	10	3,96 €
2153310600	3/4"	1	10	6,20 €
2153310700	1	1	5	10,40 €
2153310800	1-1/4"	1	5	16,25 €

**BOCCHETTONE PIANO CURVO
MASCHIO-FEMMINA 3 PZ**

In ottone giallo.



Cod.	Ø	Pz	Conf.	Prezzo
2163310500	1/2"	1	10	5,67 €
2163310600	3/4"	1	10	9,09 €
2163310700	1	1	5	13,90 €
2163310800	1-1/4"	1	5	21,05 €

BARILOTTO 2 FILETTI MM

In ottone giallo.



Cod.	Ø	mm	Conf.	Prezzo
2128500560	1/2"	60	10	2,88 €
2128500500	1/2"	100	10	5,02 €
2128500660	3/4"	60	10	4,13 €
2128500600	3/4"	100	10	7,05 €
2128500760	1"	60	10	5,98 €
2128500700	1"	100	10	9,37 €
2128500860	1-1/4"	60	10	8,01 €
2128500800	1-1/4"	100	10	13,35 €
2128500900	1-1/2"	100	10	18,05 €

PROLUNGA MF - FIG 592

In ottone giallo.



Cod.	Ø	mm	Conf.	Prezzo
2125290510	1/2"	10	10	1,19 €
2125290515	1/2"	15	10	1,58 €
2125290520	1/2"	20	10	1,79 €
2125290525	1/2"	25	10	2,15 €
2125290530	1/2"	30	10	2,26 €
2125290540	1/2"	40	10	2,99 €
2125290610	3/4"	10	10	1,70 €
2125290615	3/4"	15	10	2,03 €
2125290620	3/4"	20	10	2,54 €
2125290630	3/4"	30	10	3,48 €
2125290640	3/4"	40	10	4,63 €

RIDUZIONE MF - FIG 241

In ottone giallo.



Cod.	Ø	Conf.	Prezzo
2122415400	1/2"x3/8"	10	0,97 €
2122416500	3/4"x1/2"	10	1,53 €
2122417500	1"x1/2"	10	3,05 €
2122417600	1"x3/4"	10	2,37 €
2122418600	1-1/4"x3/4"	1	5,64 €
2122418700	1-1/4"x1"	1	4,80 €
2122419700	1-1/2"x1"	1	6,55 €
2122419800	1-1/2"x1-1/4"	1	4,29 €
2122411080	2"x1-1/4"	1	11,75 €
2122411090	2"x1-1/2"	1	9,93 €

TEE FF- FIG 130

In ottone giallo.



Cod.	Ø	Conf.	Prezzo
2121300400	3/8"	10	3,39 €
2121300500	1/2"	10	2,94 €
2121300600	3/4"	10	4,69 €
2121300700	1"	10	8,41 €
2121300800	1 1/4"	1	14,70 €
2121300900	1 1/2"	1	20,35 €
2121301000	2"	1	29,35 €

GOMITO 90° FF

In ottone giallo.



Cod.	Ø	Conf.	Prezzo
2120900400	3/8"	10	2,71 €
2120900500	1/2"	10	2,77 €
2120900600	3/4"	10	4,63 €
2120900700	1"	10	6,77 €
2120900800	1 1/4"	1	12,20 €
2120900900	1 1/2"	1	17,30 €
2120901000	2"	1	27,90 €

GOMITO MF - FIG 92

In ottone giallo.



Cod.	Ø	Conf.	Prezzo
2120920400	3/8"	10	2,82 €
2120920500	1/2"	10	2,65 €
2120920600	3/4"	10	4,29 €
2120920700	1"	10	7,17 €
2120920800	1 1/4"	1	13,00 €
2120920900	1 1/2"	1	19,70 €
2120921000	2"	1	30,40 €

MANICOTTO RIDUZIONE FM - FIG 245

In ottone giallo.



Cod.	Ø	Conf.	Prezzo
2122465400	1/2"x3/8"	10	1,36 €
2122466500	3/4"x1/2"	10	2,03 €
2122467500	1"x1/2"	10	3,39 €
2122467600	1"x3/4"	10	3,50 €
2122468700	1 1/4"x1"	1	5,42 €
2122469700	1 1/2"x1"	1	7,90 €
2122469800	1 1/2"x1 1/4"	1	8,24 €
2122461090	2"x1 1/2"	1	13,00 €

MANICOTTO - FIG 270

In ottone giallo.



Cod.	Ø	Conf.	Prezzo
2122700400	3/8"	10	1,81 €
2122700500	1/2"	10	2,03 €
2122700600	3/4"	10	2,60 €
2122700700	1"	10	4,06 €
2122700800	1 1/4"	1	5,64 €
2122700900	1 1/2"	1	8,91 €
2122701000	2"	1	14,25 €

TAPPO M - FIG 290

In ottone giallo.



Cod.	Ø	Conf.	Prezzo
2122900400	3/8"	10	0,88 €
2122900500	1/2"	10	1,08 €
2122900600	3/4"	10	1,70 €
2122900700	1"	10	2,94 €
2122900800	1 1/4"	1	5,31 €
2122900900	1 1/2"	1	6,21 €
2122901000	2"	1	12,00 €

MANICOTTO RIDOTTO FF - FIG 240

In ottone giallo.



Cod.	Ø	Conf.	Prezzo
2122405400	1/2"x3/8"	10	1,92 €
2122406500	3/4"x1/2"	10	2,88 €
2122407600	1"x3/4"	10	3,95 €
2122408700	1 1/4"x1"	1	6,43 €
2122409700	1 1/2"x1"	1	9,70 €
2122409800	1 1/2"x1 1/4"	1	12,60 €
2122401080	2"x1 1/4"	1	16,15 €
2122401090	2"x1 1/2"	1	15,80 €

TAPPO F - FIG 300

In ottone giallo.



Cod.	Ø	Conf.	Prezzo
2123000400	3/8"	10	0,85 €
2123000500	1/2"	10	0,97 €
2123000600	3/4"	10	1,45 €
2123000700	1"	10	2,32 €
2123000800	1 1/4"	1	3,61 €
2123000900	1 1/2"	1	4,85 €

NIPPLES - FIG 280

In ottone giallo.



Cod.	Ø	Conf.	Prezzo
2122800400	3/8"	10	1,19 €
2122800500	1/2"	10	1,30 €
2122800600	3/4"	10	1,92 €
2122800700	1"	10	3,05 €
2122800800	1 1/4"	1	5,64 €
2122800900	1 1/2"	1	7,22 €
2122801000	2"	1	11,55 €

GUARNIZIONE OR PER BOCCHETTONE OTTONE



Cod.	Misura	Conf.	Prezzo
143610	1/2"	1	0,12 €
143611	3/4"	1	0,14 €
143612	1"	1	0,16 €

TUBO CON 1 BICCHIERE IN P.P.H.T.



Cod.	Misura	Conf.	Prezzo
PI620010	Ø 40 x150	20	1,11 €
PI620011	Ø 40x250	20	1,36 €
PI620012	Ø 40x500	20	1,91 €
PI620013	Ø 40x1000	20	3,01 €
PI620014	Ø 40x1500	20	4,46 €
PI620016	Ø 50x500	20	2,28 €
PI620017	Ø 50x1000	10	3,78 €

CURVA IN P.P.H.T.

Varie curvature.



Cod.	Misura	Conf.	Prezzo
PI620020	Ø 40x15°	20	1,05 €
PI620021	Ø 40x30°	20	1,05 €
PI620022	Ø 40x45°	20	1,05 €
PI620023	Ø 40x67,5°	20	1,05 €
PI620024	Ø 40x87,5°	20	1,05 €
PI620026	Ø 50x45°	10	1,29 €
PI620027	Ø 50x87,5°	10	1,29 €

BRAGA IN P.P.H.T.

Varie curvature.



Cod.	Misura	Conf.	Prezzo
PI620030	Ø 40/32x45°	40	3,67 €
PI620031	Ø 40/40x45°	20	2,00 €
PI620037	Ø 40/40x67,5°	20	2,42 €

RACCORDO CURVO P.P.H.T. PER TUBO METALLO



Cod.	Misura	Conf.	Prezzo
PI620041	Ø 40x40	20	1,11 €

RACCORDO DRITTO IN P.P.H.T. PER TUBO IN METALLO



Cod.	Misura	Conf.	Prezzo
PI620051	Ø 40x46	40	0,77 €

MANICOTTO SCORREVOLE IN P.P.H.T.



Cod.	Misura	Conf.	Prezzo
PI620061	Ø 40	20	1,57 €

TAPPO IN P.P.H.T.



Cod.	Misura	Conf.	Prezzo
PI620071	Ø 40	20	0,77 €

VALVOLA A SFERA FEMMINA-FEMMINA NICHELATA

Con leva alluminio nichelata.



Cod.	Misura	Conf.	Prezzo
2104010400	3/8"	36	5,29 €
2104010500	1/2"	36	5,85 €
2104010600	3/4"	24	8,80 €
2104010700	1"	12	17,05 €
2104010800	1"1/4	8	27,25 €
2104010900	1"1/2	4	39,20 €
2104011000	2"	4	63,80 €

VALVOLA A SFERA MASCHIO-FEMMINA NICHELATA

Con leva alluminio verniciata.



Cod.	Misura	Conf.	Prezzo
2104040400	3/8"	36	5,92 €
2104040500	1/2"	36	6,29 €
2104040600	3/4"	24	9,62 €
2104040700	1"	12	17,85 €
2104040800	1"1/4	8	27,95 €
2104040900	1"1/2	4	40,80 €
2104041000	2"	4	66,60 €

VALVOLA A SFERA MASCHIO-FEMMINA NICHELATA

Con leva alluminio nichelata rossa.

BL17800020 - 1/2"
BL17800040 - 3/4"



Cod.	Misura	Conf.	Prezzo
GA7046M	1/2"	36	6,08 €
GA7047M	3/4"	24	8,17 €
GA7048M	1"	12	13,35 €
GA7049M	1"1/4	8	20,65 €

VALVOLA A SFERA FEMMINA-FEMMINA NICHELATA

Con leva alluminio verniciata rossa.

BL17800014 - 3/8"
BL17800015 - 1/2"
BL17800038 - 3/4"



BL8



Cod.	Misura	Conf.	Prezzo
GA70455	3/8"	50	5,03 €
GA7046	1/2"	36	5,67 €
GA7047	3/4"	24	7,76 €
GA7048	1"	12	12,60 €
GA7049	1"1/4	8	19,80 €
142146	1 - 1/2"	1	36,70 €
142147	2"	1	57,30 €

VALVOLA A SFERA FEMMINA-FEMMINA FARFALLA

Con leva alluminio verniciata rossa.

BL17800270
BL17800275



BL8



Cod.	Misura	Conf.	Prezzo
2124010400	3/8"	36	5,58 €
2124010100	1/2"	36	5,44 €
2124010200	3/4"	24	7,37 €
2124010700	1"	12	13,25 €

VALVOLA A SFERA MASCHIO-FEMMINA FARFALLA

Con leva alluminio verniciata rossa.

BL17800280
BL17800285



BL8



Cod.	Misura	Conf.	Prezzo
2124020400	3/8"	36	6,26 €
2124020100	1/2"	36	5,81 €
2124020200	3/4"	24	7,81 €
2124020700	1"	12	13,95 €

RUBINETTO A SFERA PESANTE

Maniglia a leva in alluminio.

BL29003000
BL29003500
BL13400013



PLAC



Cod.	Misura	g	Conf.	Prezzo
GA7030	3/8"-3/4"	260	20	9,97 €
GA7035	1/2"-3/4"	260	20	9,95 €
GA7040	3/4"-1"	338	12	12,10 €
GA7045	1"-1"1/4	507	8	17,85 €

RUBINETTO A SFERA LEGGERO

Tipo ITAP.



Cod.	Misura	g	Conf.	Prezzo
RB1100	1/2"	180	1	6,32 €
RB1101	3/4"	225	1	10,30 €

RUBINETTO A SFERA ANTIGELO

Tipo SPIN. Elevata resistenza al gelo.



Cod.	Misura	Conf.	Prezzo
PI140010	1/2"	20	10,15 €
PI140015	3/4"	12	12,40 €

RUBINETTO VALVOLA SFERA

BL17800010
BL17800055



BL1/BL5



Cod.	Misura	Conf.	Prezzo
GA1803	1/4" F/F	20	5,49 €
GA1804	3/8" F/F	20	4,83 €
GA1805	1/2" F/F	20	5,63 €

RUBINETTO VALVOLA SFERA

BL17800005
BL29008110



BL1/BL2



Cod.	Misura	Conf.	Prezzo
GA1809	1/4" M/F	20	5,34 €
GA1810	3/8" M/F	20	5,17 €
GA1811	1/2" M/F	20	5,54 €

RACCORDO PORTAGOMMA OTTONE GIALLO MASCHIO

Mod. Roma.



Cod.	mm	Conf.	Prezzo
PI700000	1/2 x 13	25	1,58 €
PI700005	1/2 x 15	25	1,85 €
PI700006	1/2" x 20	10	1,90 €
PI700010	3/4 x 20	10	2,71 €
PI700011	3/4" x 25	10	3,61 €
PI700015	1" x 25	10	4,31 €
PI700020	1" x 30	10	4,31 €
PI700025	1 1/4" x 30	1	5,87 €
PI700030	1 1/4" x 40	1	7,90 €
PI700035	2" x 50	1	14,35 €
PI700040	2" x 60	1	22,60 €

RACCORDO PORTAGOMMA OTTONE GIALLO FEMMINA



Cod.	mm	Conf.	Prezzo
PI290000	1/2 x 13	10	3,57 €
PI290001	1/2 x 15	10	2,43 €
PI290002	1/2 x 20	10	3,41 €
PI290003	3/4 x 20	10	3,24 €
PI290004	3/4 x 25	10	4,55 €
PI290005	1" x 25	10	4,71 €
PI290006	1" x 30	10	6,98 €
PI290007	1 1/4" x 30	5	10,75 €
PI290008	1 1/2" x 40	5	13,30 €
PI290009	2" x 50	5	27,75 €

PORTAGOMMA IN OTTONE



Cod.	Misura	Conf.	Prezzo
GA1790	3/4"x15 - Ø 1/2"	25	1,39 €
GA1791	1"x20 - Ø 3/4"	25	2,18 €
GA1792	1 1/4"x25 - Ø 1"	20	4,57 €

PORTAGOMMA IN OTTONE CROMATO



Cod.	Misura	Conf.	Prezzo
GA1795	3/4"x15 - Ø 1/2"	25	1,35 €
GA1796	1"x20 - Ø 3/4"	25	2,30 €
GA1797	1 1/4"x25 - Ø 1"	20	4,92 €

RUBINETTO A SFERA DIRITTO PORTAGOMMA FEMMINA

Con leva alluminio gialla.



Cod.	Descrizione	Misura	Attacco	Conf.	Prezzo
3101040500	gas metano	1/2"	M	20	9,01 €
3101060500	GPL	1/2"	F	20	6,84 €

RUBINETTO A SFERA DIRITTO PORTAGOMMA MASCHIO

Con leva alluminio giallo.



Cod.	Descrizione	Misura	Attacco	Conf.	Prezzo
3101050500	gas metano	1/2"	M	20	9,15 €
3101070500	GPL	1/2"	M	20	6,90 €

RUBINETTO A SFERA PORTAGOMMA FEMMINA

Con levetta alluminio gialla.



Cod.	Descrizione	Misura	g	Conf.	Prezzo
3101140500	gas metano	1/2"	152	20	9,41 €
3101160500	GPL	1/2"	139	20	7,22 €

RUBINETTO A SFERA PORTAGOMMA MASCHIO

Con levetta alluminio gialla.



Cod.	Descrizione	Misura	g	Conf.	Prezzo
3101150500	gas metano	1/2"	157	20	9,50 €
3101170500	GPL	1/2"	142	20	7,29 €

RUBINETTO A SFERA SQUADRA

Con levetta alluminio gialla.



Cod.	Misura	Attacco	g	Conf.	Prezzo
3101100500	1/2"x1/2"	F/F	147	20	6,83 €

RUBINETTO A SFERA SQUADRA

Con levetta alluminio gialla.



Cod.	Misura	Attacco	g	Conf.	Prezzo
3101110500	1/2"x1/2"	M/F	152	20	6,89 €

RUBINETTO A SFERA

Con levetta alluminio gialla.



Cod.	Misura	Attacco	g	Conf.	Prezzo
3101130500	1/2"x1/2"	M/M	149	20	6,84 €

RUBINETTO A SFERA DIRITTO

Con leva in alluminio gialla.



Cod.	Misura	Attacco	g	Conf.	Prezzo
3101000500	1/2"	F/F	141	20	6,25 €
3101010500	1/2"	M/F	143	20	6,34 €
3101030500	1/2"	M/M	143	20	6,29 €

RUBINETTO A SFERA CON DADO GIREVOLE PER GAS METANO

Per metano.
Con leva alluminio gialla.



Cod.	Misura	Conf.	Prezzo
3101190500	1/2" M x 1/2" D	20	9,87 €

RACCORDO PORTAGOMMA SQUADRA PER GPL E METANO

BL16600025
BL16600037



BL1



Cod.	Attacco	Conf.	Prezzo
32000525	F 1/2 per GPL	10	3,57 €
32000537	F 1/2 per metano	10	4,06 €

RACCORDO PORTAGOMMA SQUADRA PER GPL E METANO

BL16600027
BL16600035



BL1



Cod.	Attacco	Conf.	Prezzo
32000527	M 1/2 per GPL	10	4,23 €
32000535	M 1/2 per metano	10	4,55 €

RACCORDO PORTAGOMMA GIALLO PER GPL

BL16600050
BL16600055



BL1



Cod.	Attacco	Ø mm	Conf.	Prezzo
32000521	M 3/8	10	25	1,62 €
32000522	M 1/2	10	25	2,11 €

RACCORDO PORTAGOMMA GPL F 1/2

BL23000520



BL1



Cod.	Attacco	Ø mm	Conf.	Prezzo
32000520	F 1/2	10	1	2,18 €

RACCORDO PORTAGOMMA METANO M 1/2

BL23000530



BL1



Cod.	Attacco	Ø mm	Conf.	Prezzo
32000530	M 1/2	14	1	2,50 €

RACCORDO PORTAGOMMA GIALLO PER METANO

BL16600032



BL1



Cod.	Attacco	Ø mm	Conf.	Prezzo
32000532	F 1/2	14	25	2,28 €

RACCORDO PORTAGOMMA GPL A 3 VIE 120°

BL16200060



BL4



Cod.	Ø mm	Conf.	Prezzo
32000500	10	1	1,82 €

RACCORDO PORTAGOMMA METANO A 3 VIE 120°

BL16200065



BL4



Cod.	Ø mm	Conf.	Prezzo
32000510	14	1	4,33 €

RUBINETTO PER FORNELLONE GPL



Cod.	Descrizione	Conf.	Prezzo
32000700	90°	1	4,15 €

RUBINETTO PER FORNELLONE METANO



Cod.	Descrizione	Conf.	Prezzo
32000710	90°	1	4,41 €

KIT MONTAGGIO TERMOCOPPIA

Con valvola di sicurezza.



Cod.	Descrizione	Conf.	Prezzo
32000720	per tutti i modelli	1	29,45 €
32000725	termocoppia di ricambio	1	7,82 €

FLESSIBILE GPL IN ACCIAIO ZINCATO

Con dadi chiave da 25.



Cod.	cm	Conf.	Prezzo
32000000	50	1	6,06 €
32000100	100	1	6,06 €

REGOLATORE BASSA PRESSIONE GPL

Taratura regolabile. Attacco orizzontale.

BL23000600



BL9



Cod.	Capacità	Conf.	Prezzo
32000600	1 kg/H	1	5,42 €

REGOLATORE BASSA PRESSIONE GPL

Taratura regolabile, attacco verticale.



Cod.	Capacità	Conf.	Prezzo
32000610	1kg/H	1	7,89 €

REGOLATORE BASSA PRESSIONE GPL

Taratura fissa. Attacco orizzontale.



Cod.	Capacità	Conf.	Prezzo
003808	1kg/H	1	7,43 €

RIDUTTORE MEDIA PORTATA GPL

Taratura fissa. Attacco orizzontale.



Cod.	Capacità	Conf.	Prezzo
32000620	4kg/H	1	13,70 €

REGOLATORE ALTA PRESSIONE IN ZAMA

Taratura regolabile. Verticale.



Cod.	Capacità	Conf.	Prezzo
32000660	6 kg/H	1	11,15 €

REGOLATORE GAS ATTACCO AGIP

Attacco Agip 22 mm.



Cod.	Capacità	Conf.	Prezzo
160074	1,0 kg/H	1	14,85 €

TUBO GAS METANO



Tubo per mandata gas Metano per uso domestico secondo la norma UNI CIG 7140. Struttura in PVC con rinforzo tessile. Temperatura d'utilizzo da -10°C a +60°C.



Cod.	Tubo Ø mm	m	Conf.	Prezzo
PN00413	13	50	1	1,55 €

TUBO GAS GPL



Studiato in particolare per collegamento bombola ed apparecchiature domestiche, fornelli, lampade a gas e radiatori da esterno. Ottima impermeabilità ed elevata resistenza alle alte temperature. Struttura flessibile in PVC con rinforzo tessile. Temperatura d'utilizzo da -10°C a +60°C.



Cod.	Tubo Ø mm	m	Conf.	Prezzo
056838	8	100	1	74,30 €

TUBO GAS FLESSIBILE RACCORDATO

Tubo gas flessibile non estensibile in acciaio inox a norma UNI-EN 14800 (CE 0068) con treccia interna in acciaio inox e guaina in plastica di copertura.



Cod.	Descrizione	Ø mm	m	Prezzo
TBGFF1000	F/F	1/2"	1	15,35 €
TBGFF1500	F/F	1/2"	1,5	18,30 €
TBGFF2000	F/F	1/2"	2	21,25 €
TBGFF3000	F/F	1/2"	3	29,75 €
TBGFF4000	F/F	1/2"	4	36,30 €
TBGMF1000	M/F	1/2"	1	15,35 €
TBGMF1500	M/F	1/2"	1,5	18,30 €
TBGMF2000	M/F	1/2"	2	21,25 €
TBGMF3000	M/F	1/2"	3	30,90 €
TBGMF4000	M/F	1/2"	4	37,50 €

CANAPA PETTINATA FINE

Confezione in sacchetto.

BL19000015



CART. PICC.



Cod.	g	Conf.	Prezzo
PI900011	100	10	3,21 €

SIGILLANTE ELASTOPLASTICO IN STRISCE PREFORMATE

Pronto all'uso, ottima adesione. Garantisce una perfetta tenuta ad acqua ed aria.

BL19000025

CART. PICC.



Cod.	Descrizione	Colore	Conf.	Prezzo
PI900020	400 gr 4 file x 45 cm	bianco	30	7,47 €

MASTICE EPOSSIDICO BICOMPONENTE

Mastice epossidico a due componenti concentrici, facile da lavorare ed applicare. Una volta indurito può essere forato, verniciato, levigato. Alta resistenza agli agenti chimici. È utilizzato per riparare condutture in PVC, acciaio, cisterne, lamiere. Si indurisce completamente dopo 24h.



Cod.	g	Conf.	Prezzo
123750	60	20	6,55 €

NASTRO IN TEFLON PER GAS



BL12200045

BL4



Cod.	mm	m	Spessore mm	Conf.	Prezzo
FU-1164	19	12	0,10	10	0,92 €

NASTRO TEFLON



BL19000020

BL4

BL12200035

PLAC



Cod.	mm	m	Spessore mm	Conf.	Prezzo
FU-1160	12	12	0,075	10	0,42 €
FU-1162	19	15	0,200	20	2,48 €

PASTA VERDE PER RACCORDI FILETTATI

Limiti di temperatura da -20° a + 90°C.



Cod.	g	Conf.	Prezzo
PI900005	150	1	1,79 €
PI900006	450	1	2,76 €

DOSATORE SALI POLIFOSFATI DOSAPLUS 3 DG CON BYPASS

Con testa in plastica e gruppo rotazionale in ottone e dadi girevoli. Contenitore con filettatura in ottone tipo BSP.



Cod.	Attacco	Conf.	Prezzo
061910	1/2"	20	48,50 €
Cod.	Descrizione	Conf.	Prezzo
064019	ricambio soffiutto	1	4,34 €

SALE POLIFOSFATO PER DOSAPLUS

Protegge i nuovi impianti e i relativi circuiti di distribuzione dalle incrostazioni di calcare. Riduce il problema della corrosione.



Cod.	Descrizione	kg	Conf.	Prezzo
061911	in cristalli	1,5	12	29,05 €

SALE POLIFOSFATO PER DOSAPLUS

Protegge i nuovi impianti e i relativi circuiti di distribuzione dalle incrostazioni di calcare. Riduce il problema della corrosione.



Cod.	Descrizione	kg	Conf.	Prezzo
061912	in polvere	1,0	12	21,10 €

FILTRO MIGNON PLUS

Contenitore trasparente, con filettatura in ottone tipo BSP. 3P SX AS.



Cod.	Descrizione	Attacco	Conf.	Prezzo
061913	Mignon	3/4"	12	25,05 €

FILTRO MEDIUM PLUS 5"

Contenitore trasparente, con filettatura in ottone tipo BSP. 3P SX TS.



Cod.	Descrizione	Attacco	Conf.	Prezzo
061914	Medium 5"	3/4"	12	26,85 €

FILTRO SENIOR PLUS 10"

Contenitore trasparente, con filettatura in ottone tipo BSP. 3P SX TS.



Cod.	Descrizione	Attacco	Conf.	Prezzo
061915	Senior 10"	3/4"	12	27,95 €
063176	Senior 10"	1"	12	41,80 €

CARTUCCIA FILO FA SX 25 MCR

Cartucce filtranti di profondità per la rimozione di sedimenti. Setto filettante in filo avvolto in polipropilene con doppia estremità aperta (DOE). 25 mcr.



Cod.	Descrizione	Pz	Conf.	Prezzo
061916	Mignon	170	1	3,57 €
061917	Medium 5"	100	1	4,04 €
061918	Senior 10"	50	1	4,20 €
062009	Senior 10" - 50 MCR	100	1	6,19 €

CARTUCCIA IN MICROFIBRA CCP SX 5 MCR 10"

Setto filtrante in microfibre di polipropilene agglomerate con doppia estremità aperta (DOE). 25 mcr.



Cod.	Descrizione	Pz	Conf.	Prezzo
061919	Senior 10"	50	1	5,71 €

CARTUCCIA RETE RL SX 50 MCR

Rete filtrante in poliestere tubolare, con doppia estremità aperta (DOE). 50 mcr.



Cod.	Descrizione	Pz	Conf.	Prezzo
061920	Mignon	40	1	7,45 €
061921	Medium 5"	100	1	8,69 €
061922	Senior 10"	50	1	12,75 €

CARTUCCIA CARBONI ATTIVI LA SX TS

Contenitore con carbone attivo granulare con doppia estremità aperta (DOE).



Cod.	Descrizione	Pz	Conf.	Prezzo
061923	Medium 5"	50	1	10,90 €
061924	Senior 10"	12	1	15,60 €

CARTUCCIA CON SALI POLIFOSFATI HA SENIOR 10 SX TS

Contenitore con polifosfato in cristalli con doppia estremità aperta (DOE).

















Cod.	Descrizione	Pz	Conf.	Prezzo
061925	Senior 10"	12	1	43,20 €



GUARNIZIONE O-RING



















Cod.	Descrizione	Conf.	Prezzo
063177	filtro 3P EPDM	1	7,45 €
063178	Dosaplus 3	1	8,69 €
063179	bicchieri Dosaplus	1	12,75 €































CODICE	DESCRIZIONE	PACKAGING	IMMAGINE	LISTINO
BL12200028	AERATORE MINIMALISTA F D.16 BLISTER	BL1		3,06 €
BL12200029	AERATORE MINIMALISTA M D.18 BLISTER	BL1		3,06 €
BL12200030	AERATORE OTT CROM A SNODO M D.24 BLISTER	BL1		5,03 €
BL12200005	AERATORE OTT CROM F22X1 C/FILTRO BLISTER	BL1		2,09 €
BL12200020	AERATORE OTT CROM M24X1 C/FILTRO 2PZ BLISTER	BL1		2,66 €
BL12200015	AERATORE OTT CROM M24X1 C/FILTRO BLISTER	BL1		2,03 €
BL12200025	AERATORE OTT CROM M28X1 C/FILTRO BLISTER	BL1		2,50 €
BL12600065	ASSORTIMENTO OR DA 17 A 20 24PZ BLISTER *	GIÀ		3,70 €
BL12600070	ASSORTIMENTO OR DA 21 A 24 24PZ BLISTER *	GIÀ		4,68 €
BL12600060	ASSORTIMENTO OR DA 4 A 16 50PZ BLISTER *	GIÀ		4,84 €
BL12600055	ASSORTIMENTO OR DA 7 A 13+ 1"-1"1/4 24PZ BLI*	GIÀ		3,68 €
PI780122	ASTA X SALISCENDI D.25 X 65CM C/SCORREVOLE BL	GIÀ		21,35 €
BL20850500	BARILOTTO ACC ZIN 2 FILETTI 100X1/2 BLISTER	PLAC		11,45 €
BL20850600	BARILOTTO ACC ZIN 2 FILETTI 100X3/4 BLISTER	PLAC		13,95 €
BL20850510	BARILOTTO ACC ZIN 2 FILETTI 10X1/2 BLISTER	PLAC		2,91 €















CODICE	DESCRIZIONE	PACKAGING	IMMAGINE	LISTINO
BL20850610	BARILOTTO ACC ZIN 2 FILETTI 10X3/4 BLISTER	PLAC		3,25 €
BL20850505	BARILOTTO ACC ZIN 2 FILETTI 150X1/2 BLISTER	PLAC		16,35 €
BL20850605	BARILOTTO ACC ZIN 2 FILETTI 150X3/4 BLISTER	PLAC		18,70 €
BL20850515	BARILOTTO ACC ZIN 2 FILETTI 15X1/2 BLISTER	PLAC		3,48 €
BL20850615	BARILOTTO ACC ZIN 2 FILETTI 15X3/4 BLISTER	PLAC		3,90 €
BL20850520	BARILOTTO ACC ZIN 2 FILETTI 20X1/2 BLISTER	PLAC		3,99 €
BL20850620	BARILOTTO ACC ZIN 2 FILETTI 20X3/4 BLISTER	PLAC		4,43 €
BL20850525	BARILOTTO ACC ZIN 2 FILETTI 25X1/2 BLISTER	PLAC		4,49 €
BL20850625	BARILOTTO ACC ZIN 2 FILETTI 25X3/4 BLISTER	PLAC		4,92 €
BL20850550	BARILOTTO ACC ZIN 2 FILETTI 50X1/2 BLISTER	PLAC		6,86 €
BL20850650	BARILOTTO ACC ZIN 2 FILETTI 50X3/4 BLISTER	PLAC		8,04 €
BL17800160	BRACCIO DOCCIA FUSO MEDIO 1/2X20CM BLISTER	PLAC		9,88 €
BL17800155	BRACCIO DOCCIA LEGGERO 1/2X30CM BLISTER	CART PICC		11,40 €
BL19000015	CANAPA PETTINATA FINE SACCHETTO 100GR BLISTER	CART PICC		4,37 €
BL17400015	CANNA JOTA ATTACCO UNIVERSALE 3/4 BLISTER	CART PICC		12,20 €































CODICE	DESCRIZIONE	PACKAGING	IMMAGINE	LISTINO
BL17400020	CANNA PONTE ATTACCO UNIVERSALE 3/4 20CM BLIST	CART PICC	 	12,70 €
BL17400025	CANNA PONTE ATTACCO UNIVERSALE 3/4 25CM BLIST	CART PICC	 	13,05 €
BL17400005	CANNA SNODO ATTACCO UNIVERS 3/4 20CM BLISTER	CART PICC	 	12,35 €
BL17400010	CANNA SNODO ATTACCO UNIVERS 3/4 25CM BLISTER	CART PICC	 	12,85 €
BL12200090	CANNUCCIA CROM AER/DOCC X RUB FILETTO F BLIS*	GIÀ	 	5,23 €
BL13000005	CANOTTO C/CARTELLA OTT CROM D.26 X 30CM BLIST	PLAC	 	5,47 €
BL13000010	CANOTTO C/CARTELLA OTT CROM D.30 X 30CM BLIST	PLAC	 	5,79 €
BL13000015	CANOTTO C/CARTELLA OTT CROM D.32 X 30CM BLIST	PLAC	 	6,10 €
BL13000020	CANOTTO C/CARTELLA OTT CROM D.40 X 30CM BLIST	PLAC	 	10,25 €
BL17800260	CARTUCCIA X MISCELATORE C/DISTRIBUZ D.40	BL5	 	10,20 €
BL17800255	CARTUCCIA X MISCELATORE S/DISTRIBUZ D.40	BL5	 	10,20 €
BL18200080	COPPIA CERNIERE OTT CROM C/VITI ESPAN BLISTER	BL9	 	13,55 €
BL18200005	COPPIA SUPPORTI UNIV C/VITI NYLON X COPR BLIS	BL8	 	2,01 €
BL18200010	COPPIA SUPPORTI UNIV C/VITI OTT X COPR BLIST	BL8	 	2,50 €
BL18200015	COPPIA SUPPORTI WC UNIV C/VITI ZAMA BLISTER	BL8	 	6,81 €















CODICE	DESCRIZIONE	PACKAGING	IMMAGINE	LISTINO
BL12200115	COPRIFORO PESANTE OTTONE CROMATO BLISTER	BL5		3,50 €
BL13400035	CURVA ABS BIANCA X LAVATR C/CALOTTA E OR BLIS	BL5		2,08 €
BL11800090	CURVA PLASTICA PER CARICO LAVATRICE BLISTER	BL4		2,47 €
BL11800095	CURVA PLASTICA PER SCARICO LAVATRICE BLISTER	CART. PICC		1,59 €
BL17800240	CURVA SALISCENDI OTT CROM C/ROSONE BLISTER	BL3		6,02 €
BL11800185	DADO OTTONE CROMATO 1" BLISTER	BL1		3,14 €
BL11800190	DADO OTTONE CROMATO 1"1/4" BLISTER	BL1		3,29 €
BL17800105	DOCGETTA MONOGETTO CROM ANTICALC D.65 BLIST *	GIÀ		7,56 €
BL17800165	DOCGETTA 3 GETTI CROM ANTICALC BLISTER *	GIÀ		19,90 €
BL17800135	DOCGETTA 5 GETTI CROM ANTICALC GEMMA BLISTER*	GIÀ		19,60 €
BL17800145	DOCGETTA 5 GETTI CROM ANTICALC DIAMANTE BLIS*	GIÀ		14,55 €
BL17800125	DOCGETTA 8 GETTI CROM ANTICALCARE BLISTER *	GIÀ		10,90 €
BL17800180	DOCGETTA CURVA X DUPLEX NORMALE BLISTER	CART PICC		9,63 €
BL17800190	DOCGETTA PESANT CROM X LEVEL CUCINA ESTR BLI	CART PICC		12,45 €
BL17800175	DOCGETTA X GRUPPI VASCA NORMALE BLISTER	CART PICC		9,00 €





CODICE	DESCRIZIONE	PACKAGING	IMMAGINE	LISTINO
BL11000180	FASCETTA STRINGIT ACC INOX 12MM 40X60 2PZ BLI	BL4		2,30 €
BL11000185	FASCETTA STRINGIT ACC INOX 12MM 50X70 2PZ BLI	PLAC		2,53 €
BL11000190	FASCETTA STRINGIT ACC INOX 12MM 60X80 2PZ BLI	PLAC		2,70 €
BL11000150	FASCETTA STRINGIT ACC INOX 9 MM 10X16 2PZ BLI	BL1		1,88 €
BL11000155	FASCETTA STRINGIT ACC INOX 9 MM 12X20 2PZ BLI	BL1		1,88 €
BL11000160	FASCETTA STRINGIT ACC INOX 9 MM 16X25 2PZ BLI	BL1		1,94 €
BL11000165	FASCETTA STRINGIT ACC INOX 9 MM 20X32 2PZ BLI	BL1		1,94 €
BL11000170	FASCETTA STRINGIT ACC INOX 9 MM 25X40 2PZ BLI	BL1		2,05 €
BL11000175	FASCETTA STRINGIT ACC INOX 9 MM 32X50 2PZ BLI	BL3		2,25 €
BL11000145	FASCETTA STRINGIT ACC INOX 9 MM 8X12 2PZ BLIS	BL1		1,88 €
BL12200150	FILTRO PLASTICA X LAVELLO/LAVABO D.31 2PZ BLI	BL5		1,52 €
BL12200155	FILTRO PLASTICA X LAVELLO/LAVABO D.40 2PZ BLI	BL5		1,52 €
BL12200160	FILTRO PLASTICA X LAVELLO/LAVABO D.52 2PZ BLI	BL5		1,52 €
BL17800060	FLESSIB DOCC BIFLEX DADI OTT FF 1/2 150CM BLI	CART GRANDE		8,68 €
BL17800025	FLESSIB DOCCIA DADI CONI/NORM FF 1/2 150CM BL	CART PICC		8,75 €















CODICE	DESCRIZIONE	PACKAGING	IMMAGINE	LISTINO
BL17800030	FLESSIB DOCCIA DADI CONI/NORM FF 1/2 200CM BL	CART PICC		11,00 €
BL17800070	FLESSIBILE RICAMBIO M15A X F 1/2 150CM BLISTE	CART PICC		13,90 €
BL17800215	GALLEGGIANTE A SCATOLA 3/8 ATT OTTONE BLISTER	CART PICC		10,55 €
BL14600005	GALLEGGIAN SILENZ BARRA OTT SEDE INOX 3/8 BLI	PLAC		13,65 €
BL12200350	GHIERA ABS CROMATO TROPPO PIENO D.19 BLISTER	BL1		1,74 €
BL12200351	GHIERA ABS CROMATO TROPPO PIENO D.24 BLISTER	BL1		1,74 €
BL12200352	GHIERA ABS CROMATO TROPPO PIENO D.28 BLISTER	BL1		1,82 €
BL24085050	GHISA CURVA SALTATUBI 1/2 BLISTER	PLAC		4,43 €
BL24221050	GHISA DISTRIBUZIONE A GOMITO 1/2 BLISTER	BL5		4,18 €
BL24090050	GHISA GOMITO FF 1/2 BLISTER	PLAC		1,54 €
BL24090060	GHISA GOMITO FF 3/4 BLISTER	PLAC		1,88 €
BL24092050	GHISA GOMITO MF 1/2 BLISTER	PLAC		1,59 €
BL24092060	GHISA GOMITO MF 3/4 BLISTER	PLAC		2,05 €
BL24270050	GHISA MANICOTTO 1/2 BLISTER	PLAC		1,77 €
BL24270060	GHISA MANICOTTO 3/4 BLISTER	PLAC		2,02 €















CODICE	DESCRIZIONE	PACKAGING	IMMAGINE	LISTINO
BL24130050	GHISA TEE FF 1/2 BLISTER	PLAC		1,74 €
BL24130060	GHISA TEE FF 3/4 BLISTER	PLAC		2,33 €
BL11800075	GIUNTO 2 VIE PER TUBO CARICO LAVATRICE BLIST	BL8		2,65 €
BL11800085	GIUNTO 3 VIE PER TUBO SCAR LAVATR D.20 BLIST	BL6		2,05 €
BL11800080	GIUNTO PLAST DIRIT X TUBO SCAR LAV. D.20 BLIS	BL2		1,33 €
BL12200010	GRIGLIA INOX BASKET BLISTER	PLAC		3,61 €
BL17800220	GRIGLIA INOX GRANDE BLISTER	PLAC		1,66 €
BL12200170	GRIGLIETTA ACCIAIO INOX BLISTER	BL4		1,67 €
BL12200165	GRIGLIETTA CROMATA X LAVABO BLISTER	BL4		2,59 €
BL12600044	GUARNIZIONE CONICA 1" D.26 2PZ BLISTER	BL1		1,45 €
BL12600050	GUARNIZIONE CONICA 1"1/2 D.40 MM 2PZ BLISTER	BL1		1,78 €
BL12600045	GUARNIZIONE CONICA 1"1/4 D.30/32 MM 2PZ BLIST	BL1		1,59 €
BL13800040	GUARNIZIONE DI FONDO PUCCI BLISTER	BL4		2,65 €
BL11800059	GUARNIZIONE GOMMA 1/2 X 2MM 10PZ BLISTER	BL1		1,29 €
BL12200195	GUARNIZIONE SCODELLINO D.19 MM BLISTER	BL1		1,14 €















CODICE	DESCRIZIONE	PACKAGING	IMMAGINE	LISTINO
BL12200200	GUARNIZIONE SCODELLINO D.29 MM BLISTER	BL1	 	1,34 €
BL11800065	GUARNIZIONE X TUBO CARICO LAVATRICE 10PZ BLIS	BL1	 	1,57 €
BL12600035	GUARNIZIONI ALLUMINIO 1/2 5PZ BLISTER	BL1	 	2,60 €
BL12600040	GUARNIZIONI IN CUOIO 1/2 5PZ BLISTER	BL1	 	1,57 €
BL12200210	GUARNIZIONI X RUBINETTI C/FORO 1/2 10PZ BLIST	BL1	 	2,28 €
BL12200205	GUARNIZIONI X RUBINETTI C/FORO 3/8 10PZ BLIST	BL1	 	2,11 €
BL12600020	GUARNIZIONI X SANITARI 1" X 2MM 20PZ BLIST	BL2	 	1,88 €
BL12600030	GUARNIZIONI X SANITARI 1"1/2 2MM 20PZ BLIST	BL7	 	3,62 €
BL12600025	GUARNIZIONI X SANITARI 1"1/4 2MM 20PZ BLIST	BL5	 	3,06 €
BL12600010	GUARNIZIONI X SANITARI 1/2 X 2MM 20PZ BLIST	BL1	 	1,69 €
BL12600032	GUARNIZIONI X SANITARI 2" 10 PZ BLISTER	BL6	 	3,53 €
BL12600015	GUARNIZIONI X SANITARI 3/4 X 2MM 20PZ BLIST	BL1	 	1,85 €
BL12600005	GUARNIZIONI X SANITARI 3/8 X 2MM 20PZ BLIST	BL1	 	1,55 €
BL12600000	GUARNIZIONI X SANITARI MISURA MISTE 25PZ BLIS	BL3	 	2,50 €
BL13400034	IMBUTO CONICO IN PARA BLISTER	BL9	 	2,50 €















CODICE	DESCRIZIONE	PACKAGING	IMMAGINE	LISTINO
BL1460030	INFILZA DORA LT.12 BLISTER	PLAC		9,63 €
BL1460035	INFILZA DORA LT.14 TIPO NUOVO BLISTER	PLAC		9,49 €
BL1460040	INFILZA DORA LT.14 TIPO VECCHIO BLISTER	PLAC		9,63 €
BL1460025	INFILZA STIR BLIZT LT.12 BLISTER	PLAC		11,20 €
BL1220026	INTERNO AREAT. REG. FLUSSO 2PZ	BL1		1,88 €
BL1220055	INTERNO PLAS AERAT C/LIM PORT D.22/24 4PZ BLI	BL1		4,65 €
BL1220050	INTERNO PLAST AERAT D.22/24 3PZ+1PZ D.28 BLI*	GIÀ		2,94 €
BL1220040	INTERNO PLASTICA X AERATORI D.22/24 4PZ BLIS*	GIÀ		3,43 €
BL1820035	KIT PARACOLPI UNIV A CHiodo X COPRIV LEG BLIS	BL6		3,49 €
BL1820040	KIT PARACOLPI UNIV AD INNES X COPRIV LEG BLIS	BL6		3,11 €
BL1820030	KIT PARACOLPI X COPRIVASO PLASTICA BLISTER	BL6		3,14 €
BL1820025	KIT PARACOLPI X SEDILI IN PLASTICA BLISTER	BL6		2,63 €
BL21702070	MANICOTTO ACCIAIO ZINCATO 1" BLISTER	BL5		3,03 €
BL21702050	MANICOTTO ACCIAIO ZINCATO 1/2 BLISTER	BL2		2,06 €
BL21702030	MANICOTTO ACCIAIO ZINCATO 1/4 BLISTER	BL1		1,97 €































CODICE	DESCRIZIONE	PACKAGING	IMMAGINE	LISTINO
BL21702060	MANICOTTO ACCIAIO ZINCATO 3/4 BLISTER	BL3		2,35 €
BL21702040	MANICOTTO ACCIAIO ZINCATO 3/8 BLISTER	BL1		1,97 €
BL16200075	MANICOTTO OTTONE CROM 1/2X1/2 F BLISTER	BL2		3,67 €
BL16200040	MANICOTTO FF 3/A	BL3		4,27 €
BL21240530	MANICOTTO RIDOTTO FF ACC ZINC 1/2X1/4 BLISTER	BL2		2,47 €
BL21240540	MANICOTTO RIDOTTO FF ACC ZINC 1/2X3/8 BLISTER	BL2		2,41 €
BL21240760	MANICOTTO RIDOTTO FF ACC ZINC 1X3/4 BLISTER	BL5		4,27 €
BL21240650	MANICOTTO RIDOTTO FF ACC ZINC 3/4X1/2 BLISTER	BL2		2,82 €
BL21240430	MANICOTTO RIDOTTO FF ACC ZINC 3/8X1/4 BLISTER	BL1		2,11 €
BL13800025	MORSETTO WON ROLL/REDI D.40 X 26/30/32MM BLIS	BL3		1,54 €
BL13800005	MORSETTO WC GOMMA BIANCA D.50 X30 MM BLISTER	BL3		1,60 €
BL13800015	MORSETTO WC MAGG.	BL4		2,56 €
BL13800010	MORSETTO WC MAGG.	BL4		1,83 €
BL13800020	MORSETTO WON ROLL/REDI D.40 X 26MM BLISTER	BL3		1,77 €
BL13800033	MORSETTO WON ROLL/REDI D.50 X 26/30/32MM BLIS	BL3		2,28 €















CODICE	DESCRIZIONE	PACKAGING	IMMAGINE	LISTINO
BL1380030	MORSETTO WON ROLL/REDI D.50 X 26MM BLISTER	BL3		2,95 €
BL1380035	MORSETTO WON ROLL/REDI D.50 X 40MM BLISTER	BL4		1,80 €
BL1900020	NASTRO IN TEFLON 12MT 12MM 0,075MM BLISTER	BL4		1,74 €
BL1220045	NASTRO IN TEFLON 12MT 19MM 0,10MM BLISTER	BL4		2,04 €
BL1220035	NASTRO IN TEFLON 15MT 19MM 0,20MM PROF. BLIST	PLAC		3,80 €
BL21531070	NIPPLES ACC ZINC TUTTO FILETTATO 1" BLISTER	BL3		3,17 €
BL21531050	NIPPLES ACC ZINC TUTTO FILETTATO 1/2 BLISTER	BL1		1,98 €
BL21531030	NIPPLES ACC ZINC TUTTO FILETTATO 1/4 BLISTER	BL1		2,14 €
BL21531060	NIPPLES ACC ZINC TUTTO FILETTATO 3/4 BLISTER	BL2		2,41 €
BL21531040	NIPPLES ACC ZINC TUTTO FILETTATO 3/8 BLISTER	BL1		1,98 €
BL21280070	NIPPLES ACCIAIO ZINCATO 1" BLISTER	BL5		4,41 €
BL21280050	NIPPLES ACCIAIO ZINCATO 1/2 BLISTER 2PZ	BL2		2,29 €
BL21280030	NIPPLES ACCIAIO ZINCATO 1/4 BLISTER 2PZ	BL1		2,11 €
BL21280060	NIPPLES ACCIAIO ZINCATO 3/4 BLISTER	BL3		2,62 €
BL21280040	NIPPLES ACCIAIO ZINCATO 3/8 BLISTER 2PZ	BL1		2,15 €















CODICE	DESCRIZIONE	PACKAGING	IMMAGINE	LISTINO
BL21245530	NIPPLES DI RIDUZIONE ACC ZINC 1/2X1/4 BLISTER	BL2		2,34 €
BL21245540	NIPPLES DI RIDUZIONE ACC ZINC 1/2X3/8 BLISTER	BL2		2,14 €
BL21245760	NIPPLES DI RIDUZIONE ACC ZINC 1X3/4 BLISTER	BL5		4,34 €
BL11800070	NIPPLE TUBO CARICO LAV.	BL2		1,37 €
BL21245650	NIPPLES DI RIDUZIONE ACC ZINC 3/4X1/2 BLISTER	BL2		2,84 €
BL21245430	NIPPLES DI RIDUZIONE ACC ZINC 3/8X1/4 BLISTER	BL1		1,98 €
BL13400031	PILETTA C/TROPPO PIENO GIGANTE 115X1"1/2 BLIS	BL10		17,75 €
BL13400030	PILETTA C/TROPPO PIENO LEVEL INOX 1"1/2 BLIST	BL10		7,11 €
BL13400020	PILETTA GATTIN X LEVEL CERAM 1"1/2 D.80 BLIST	CART PICC		3,48 €
BL13400015	PILETTA GATTIN X LEVEL CERAM 1"1/4 D.80 BLIST	CART PICC		3,48 €
BL13400090	PILETTA LAVABO/BIDET C/TROPPO PIENO 1" BLISTE	CART PICC		12,40 €
BL13400095	PILETTA LAVABO/BIDET C/TROPPO PIENO 1"1/4 BLI	CART PICC		14,50 €
BL13400032	PILETTA S/TROPPO PIENO GIGANTE 115X1"1/2 BLIS	CART PICC		15,25 €
BL12200250	PILETTA SCARICO 1" BLISTER	CART PICC		13,95 €
BL12200255	PILETTA SCARICO 1"1/4 BLISTER	CART PICC		17,40 €







CODICE	DESCRIZIONE	PACKAGING	IMMAGINE	LISTINO
BL13400025	PILETTA SENZA TROPPO PIENO LAV INOX 1"1/2 BLI	CART PICC		4,83 €
BL16600050	PORTAGOMMA GPL M 3/8 BLISTER	BL1		2,83 €
BL17800085	PORTASAPONE RICAMBIO X SALISCENDI	PLAC		6,88 €
BL21529051	PROLUNGA ACC ZINC 1/2 X 1 CM PESANTE BLISTER	BL2		1,77 €
BL21529053	PROLUNGA ACC ZINC 1/2 X 1,5 CM PESANTE BLISTE	BL2		1,79 €
BL21529052	PROLUNGA ACC ZINC 1/2 X 2 CM PESANTE BLISTER	BL2		1,91 €
BL21529061	PROLUNGA ACC ZINC 3/4 X 1 CM PESANTE BLISTER	BL2		2,47 €
BL21529062	PROLUNGA ACC ZINC 3/4 X 1,5 CM PESANTE BLIST	BL2		2,64 €
BL21529063	PROLUNGA ACC ZINC 3/4 X 2 CM PESANTE BLISTER	BL3		2,81 €
BL21529041	PROLUNGA ACC ZINC 3/8 X 1 CM PESANTE BLISTER	BL1		1,86 €
BL21529042	PROLUNGA ACC ZINC 3/8 X 1,5 CM PESANTE BLIST	BL2		1,91 €
BL21529043	PROLUNGA ACC ZINC 3/8 X 2 CM PESANTE BLISTER	BL2		2,02 €
BL16600030	PROLUNGA ECCENTR GOMMA BIA SCAR WC D.110 BLIS	CART GRANDE		3,12 €
BL16200090	PROLUNGA GOMMA BIANCA X SCARICO WC D.110 BLIS	CART GRANDE		3,12 €
BL21246560	PROLUNGA RIDOTTA MF ACC ZINC 1/2X3/4 BLISTER	BL2		2,64 €































CODICE	DESCRIZIONE	PACKAGING	IMMAGINE	LISTINO
BL21246340	PROLUNGA RIDOTTA MF ACC ZINC 1/4X3/8 BLISTER	BL1		2,16 €
BL21246670	PROLUNGA RIDOTTA MF ACC ZINC 3/4X1 BLISTER	BL5		3,76 €
BL21246450	PROLUNGA RIDOTTA MF ACC ZINC 3/8X1/2 BLISTER	BL2		2,01 €
BL16200080	RACCORDO A L F-F 1/2 BLISTER	BL2		4,48 €
BL16200085	RACCORDO A L F-F 3/4 BLISTER	BL3		6,74 €
BL16200070	RACCORDO A L M-F 1/2 BLISTER	BL2		4,10 €
BL16200072	RACCORDO A L OTTONE M-F 3/4 BLISTER	BL3		5,56 €
BL11000300	RACCORDO BICONO CR DADO SVAS 10X10 3/8 BL 2PZ	BL1		11,55 €
BL11000310	RACCORDO BICONO CR F 1/2X3/8 D.10 BL 2PZ	BL2		6,59 €
BL11000410	RACCORDO BICONO CROM M 1/2X3/8 D.10 BLISTER	BL2		3,83 €
BL11000400	RACCORDO BICONO CROM M 3/8X3/8 D.10 BLISTER	BL1		4,32 €
BL16200030	RACCORDO OTTONE CROM TEE F/F/F 1/2 BLISTER	BL2		4,53 €
BL16200035	RACCORDO OTTONE CROM TEE F/F/F 3/4 BLISTER	BL3		6,74 €
BL16200040	RACCORDO OTTONE CROM MANICOTTO F/F 3/4 BLISTER	BL3		4,27 €
BL21081550	RACCORDO OTTONE CROM VITE DOPPIA M/M 1/2 BLISTER	BL2		2,59 €















CODICE	DESCRIZIONE	PACKAGING	IMMAGINE	LISTINO
BL16200045	RACCORDO OTTONE CROM VITE DOPPIA M/M 3/4 BLIS	BL3	 	BL16200045
BL16200020	RACCORDO OTTONE TAPPO F 1/2 BLISTER	BL1	 	BL16200020
BL16200025	RACCORDO OTTONE TAPPO F 3/4 BLISTER	BL1	 	BL16200025
BL16200010	RACCORDO OTTONE TAPPO M 1/2 BLISTER	BL1	 	BL16200010
BL16200015	RACCORDO OTTONE TAPPO M 3/4 BLISTER	BL1	 	BL16200015
BL16200060	PORTAGOMMA GPL 3 VIE D.10 120° BLISTER	BL4	 	BL16200060
BL16600055	PORTAGOMMA GPL	BL1	 	BL16600055
BL16600050	PORTAGOMMA GPL	BL1	 	BL16600050
BL23000520	PORTAGOMMA GPL F 1/2 D.10 BLISTER	BL1	 	BL23000520
BL16200065	RACCORDO PORTAGOMMA METANO 3 VIE D.14 120° BL	BL4	 	BL16200065
BL16600032	PORTAGOMMA METANO F 1/2 BLISTER	BL1	 	BL16600032
BL23000530	PORTAGOMMA METANO M 1/2 D.14 BLISTER	BL1	 	BL23000530
BL16600025	RACCORDO PORTAGOMMA SQUADRA GPL F 1/2 BLISTER	BL1	 	BL16600025
BL16600027	RACCORDO PORTAGOMMA SQUADRA GPL M 1/2 BLISTER	BL1	 	BL16600027
BL16600037	RACCORDO PORTAGOMMA SQUADRA METANO F 1/2 BLIS	BL1	 	BL16600037

CODICE	DESCRIZIONE	PACKAGING	IMMAGINE	LISTINO
BL16600035	RACCORDO PORTAGOMMA SQUADRA METANO M 1/2 BLIS	BL1		5,75 €
BL23000600	REGOLATORE BP GPL TAR. REG. 1KG/H ATT.ORIZ.BL	BL9		5,80 €
BL18600005	RICAMBIO SCOPINO C/MANIC E FIOC IN SETOLA BLI	PLAC		3,40 €
BL17800100	RIDUZIONE FILETT POLIP F 1"1/2 X M 1"1/4 BLIS	BL4		1,80 €
BL17800110	RIDUZIONE FILETT POLIP F 1"1/4 X M 1"1/2 BLIS	BL4		2,02 €
BL17800120	RIDUZIONE FILETTATA POLIP F 1" X M 1"1/4 BLIS	BL4		1,90 €
BL17800115	RIDUZIONE FILETTATA POLIP M 1" X F 1"1/4 BLIS	BL4		1,89 €
BL21241530	RIDUZIONE MF ACCIAIO ZINCATO 1/2X1/4 BLISTER	BL2		1,82 €
BL21241540	RIDUZIONE MF ACCIAIO ZINCATO 1/2X3/8 BLISTER	BL2		1,74 €
BL21241760	RIDUZIONE MF ACCIAIO ZINCATO 1X3/4 BLISTER	BL4		3,25 €
BL21241650	RIDUZIONE MF ACCIAIO ZINCATO 3/4X1/2 BLISTER	BL2		2,06 €
BL21241430	RIDUZIONE MF ACCIAIO ZINCATO 3/8X1/4 BLISTER	BL1		1,73 €
BL12200065	RIDUZIONE OTT CROM AERAT. F22XM1/2 FLEX BLIST	BL1		4,00 €
BL12200070	RIDUZIONE OTT CROM AERAT. F22XM3/4 GIARD BLIS	BL1		4,32 €
BL19000005	RIDUZIONE OTT CROM CON 2 OR D.32/26 BLISTER	BL8		5,84 €















CODICE	DESCRIZIONE	PACKAGING	IMMAGINE	LISTINO
BL19000010	RIDUZIONE OTT CROM CON 2 OR D.40/32 BLISTER	BL9		6,28 €
BL12200063	RIDUZIONE OTT CROM X AERATORE M24XM22 BLISTER	BL1		3,45 €
BL12200063	RIDUZIONE OTT.CROM. X AERAT M24XM1/2 BLIS	BL1		3,45 €
BL12200063	RIDUZIONE OTTONE X RUBINETTI 3/8 X 1/2 BLISTE	BL1		3,45 €
BL21241750	RIDUZIONE RIDOTTA MF - FIG. 241	BL2		3,34 €
BL12200075	ROMPIGETTO AERATORE/DOCCETTA	BL3		4,23 €
BL12200075	ROSONE ACCIAIO INOX D.60 1/2 BLISTER	BL4		4,23 €
BL12200075	ROSONE ACCIAIO INOX D.60 X 3/8 BLISTER	BL4		4,23 €
BL13000050	ROSONE APRIB DOPPIO PP BIA DA D.10 A D.22 BLI	BL6		1,90 €
BL13000045	ROSONE APRIBILE PP BIANCO DA D.8 A D.22 BLIST	BL4		1,35 €
BL12200230	ROSONE OTT CROM A CONO H32 D75-D40 MM BLISTER	PLAC		3,70 €
BL12200215	ROSONE OTTONE CROMATO H28 D75-D26 MM BLISTER	PLAC		2,59 €
BL12200220	ROSONE OTTONE CROMATO H28 D75-D30 MM BLISTER	PLAC		2,59 €
BL12200225	ROSONE OTTONE CROMATO H28 D75-D32 MM BLISTER	PLAC		2,59 €
BL13000055	ROSONE PESANTE APRIB CROM DA D.8 A D.22 BLIST	BL4		2,30 €

CODICE	DESCRIZIONE	PACKAGING	IMMAGINE	LISTINO
BL11800099	RUBINETTO A SFERA X CASSETTA 1/2"X1/2" BLIST	BL8		8,29 €
BL11800020	RUBINETTO A VITONE 3 VIE 1/2X1/2X3/4 BLISTER	BL5		9,71 €
BL11800030	RUBINETTO DOPPIO X LAVATRICE 1/2 3/4 BLISTER	PLAC		20,00 €
BL11800025	RUBINETTO LAVATR A SFERA C/ROSET 1/2X3/4 BLIS	BL5		6,71 €
BL11800015	RUBINETTO LAVATRICE 1/2 BLISTER	BL9		15,20 €
BL11800010	RUBINETTO LAVATRICE 3/8 BLISTER	BL8		11,80 €
BL29003500	RUBINETTO SFERA 1/2" PESANTE BLISTER	PLAC		11,05 €
BL13400013	RUBINETTO SFERA 3/4" PESANTE BLISTER	PLAC		13,10 €
BL29003000	RUBINETTO SFERA 3/8" PESANTE BLISTER	PLAC		11,05 €
BL17800250	RUBINETTO SNODO PESANTE CANNA A S CROM BLISTE	CART PICC		22,90 €
BL11400005	RUBINETTO SOTTOLAV OTT C/SNODO 1/2X3/8 D10 BL	PLAC		12,65 €
BL17800055	RUBINETTO VALVOLA SFERA MINI F/F 1/2 BLISTER	BL5		6,25 €
BL17800010	RUBINETTO VALVOLA SFERA MINI F/F 3/8 BLISTER	BL1		6,07 €
BL29008110	RUBINETTO VALVOLA SFERA MINI M/F 1/2 BLISTER	BL2		6,80 €
BL17800005	RUBINETTO VALVOLA SFERA MINI M/F 3/8 BLISTER	BL1		5,55 €

CODICE	DESCRIZIONE	PACKAGING	IMMAGINE	LISTINO
BL12200175	RULLINO PORTACARTA BIANCO BLISTER	BL6	 	1,89 €
PI780103	SALISCENDI ASTA C/DOCCIA 3 GETTI TOPAZIO BL	GIÀ	 	33,50 €
PI780105	SALISCENDI ASTA CROM C/DOCCIA 5 GETTI AVOR BL	GIÀ	 	48,90 €
PI780100	SALISCENDI ASTA CROM C/DOCCIA MONO QUARZO	GIÀ	 	23,70 €
BL12200100	SALTARELLO X PILETTA LAV/BID 1" D.36 STD BLIS	BL3	 	4,90 €
BL12200105	SALTARELLO X PILETTA LAV/BID 1"1/4 D.39 BLIST	BL5	 	5,06 €
BL12200110	SALTARELLO X PILETTA VASCA D.42 STD BLISTER	BL5	 	5,53 €
BL17800095	SCORREVOLE RICAMBIO X SALISCENDI D.22 BLISTER	PLAC	 	4,99 €
BL17800090	SCORREVOLE RICAMBIO X SALISCENDI D.25 BLISTER	PLAC	 	6,56 €
BL13800045	SET RIC PUCCI GUARNIZ+MEMBR PULS BLISTER	BL4	 	4,73 €
BL14600020	SFERA IN PARA D.57 BLISTER	BL5	 	3,54 €
BL14600015	SFERA IN PARA D.58 BLISTER	BL5	 	3,63 €
BL14600010	SFERA PLAST PIATTA C/NOTTOLINO OTT D.90 BLIST	CART PICC	 	1,99 €
BL13400060	SIFONE A S S/PILETTA CANOTTO 20 CM 1" BLISTER	BL10	 	19,00 €
BL13400065	SIFONE A S S/PILETTA CANOTTO 20 CM 1"1/4 BLIS	BL10	 	19,85 €









CODICE	DESCRIZIONE	PACKAGING	IMMAGINE	LISTINO
BL13400070	SIFONE A U OTT CROM CANOTTO 20 CM 1" BLISTER	BL10		19,00 €
BL13400085	SIFONE A U OTT CROM CANOTTO 20 CM 1"1/4 BLIST	BL10		19,20 €
BL13400050	SIFONE BOTT OTT CROM CANOTTO 20 CM 1" BLISTER	BL10		17,80 €
BL13400055	SIFONE BOTT OTT CROM CANOTTO 20 CM 1"1/4 BLIS	BL10		18,40 €
BL13400010	SIFONE FIASCA 1"1/4 D.32 2 VIE C/RID BLISTER	CART GRANDE		10,60 €
BL13400005	SIFONE FIASCA 1"1/4 D.32 C/RID M1"1/4 XF BLIST	CART GRANDE		6,91 €
BL17800130	SIFONE FIASCA 1"1/2 X D40 C/ATT LAV BLISTER	CART GRANDE		8,73 €
BL13400012	SIFONE PRATIK 1 VIA 1"1/2 X D.40 BLISTER	CART GRANDE		17,25 €
BL19000025	SIGILLANTE ELASTOPLASTIC 4 STRISCE X 45CM BLI	CART PICC		8,58 €
BL17800225	SOFFIONE DOCCIA ABS CROMO/NERO BLISTER	CART PICC		8,18 €
BL17800150	SOFFIONE DOCCIA LASTRA OTTONE CROM BLISTER	CART PICC		13,30 €
PI780290	SOFFIONE DOCCIA MONOGETTO ANTICALCARE D.15	CART PICC		13,35 €
BL17800245	SUPPORTO ESTERNO OTT X DOCCETTA DUPLEX BLIST	CART PICC		8,58 €
BL17800205	SOFFIONE DOCCIA MONOGETTO CROM ANTICALC BLIST	CART PICC		13,95 €
BL17800075	SUPPORTO ESTERNO OTTONE X FLESS CONICO BLISTE	CART PICC		8,24 €

CODICE	DESCRIZIONE	PACKAGING	IMMAGINE	LISTINO
BL21300070	TAPPO F ACCIAIO ZINCATO 1" BLISTER 2PZ	BL4		8,43 €
BL21300050	TAPPO F ACCIAIO ZINCATO 1/2 BLISTER 2PZ	BL1		2,61 €
BL21300030	TAPPO F ACCIAIO ZINCATO 1/4" BLISTER 2PZ	BL1		3,03 €
BL21300060	TAPPO F ACCIAIO ZINCATO 3/4 BLISTER 2PZ	BL2		3,20 €
BL21300040	TAPPO F ACCIAIO ZINCATO 3/8 BLISTER 2PZ	BL1		2,47 €
BL21290070	TAPPO M ACCIAIO ZINCATO 1" BLISTER	BL4		4,38 €
BL21290050	TAPPO M ACCIAIO ZINCATO 1/2 BLISTER	BL1		2,28 €
BL21290030	TAPPO M ACCIAIO ZINCATO 1/4 BLISTER	BL1		2,24 €
BL21290060	TAPPO M ACCIAIO ZINCATO 3/4 BLISTER	BL2		2,82 €
BL21290040	TAPPO M ACCIAIO ZINCATO 3/8 BLISTER	BL1		2,30 €
BL12200145	TAPPO NERO C/MANIGLIA D.52 BLISTER	BL1		1,73 €
BL12200147	TAPPO NERO C/PLACCA INOX C/MANIGLIA D.52 BLIS	BL2		2,24 €
BL12200117	TAPPO NERO C/PLACCA INOX E CATENA D.27 BLIST	BL1		3,07 €
BL12200120	TAPPO NERO C/PLACCA INOX E CATENA D.31 BLIST	BL1		3,09 €
BL12200125	TAPPO NERO C/PLACCA INOX E CATENA D.40 BLIST	BL1		3,18 €

CODICE	DESCRIZIONE	PACKAGING	IMMAGINE	LISTINO
BL12200130	TAPPO NERO C/PLACCA INOX E CATENA D.44 BLIST	BL1		3,29 €
BL12200135	TAPPO NERO C/PLACCA INOX E CATENA D.47 BLIST	BL1		3,38 €
BL12200140	TAPPO NERO C/PLACCA INOX E CATENA D.52 BLIST	BL1		3,46 €
BL12200098	TAPPO UNIVERSALE BASKET SCATTINO BLISTER	CART PICC		6,79 €
BL13000033	TUBO ALLUNG C/DADO METAL 1"1/4 X D.32/40 BLIS	CART PICC		3,71 €
BL13000025	TUBO ALLUNGABILE C/DADO METALLO 1" D.32 BLIST	CART PICC		3,71 €
BL13000035	TUBO ALLUNGABILE C/DADO METALLO 1"1/2 D.40 BL	CART PICC		3,71 €
BL11800050	TUBO CARICO LAV. F3/4 X F3/4 CURVA 150CM BLI	CART GRANDE		4,35 €
BL11800055	TUBO CARICO LAV. F3/4 X F3/4 CURVA 200CM BLI	CART GRANDE		4,68 €
BL11800060	TUBO CARICO LAV. F3/4 X F3/4 CURVA 250CM BLI	CART GRANDE		4,60 €
BL11000130	TUBO FLESSIB ACC INOX M1/2XBIC10 35CM BLISTER	PLAC		5,25 €
BL11000140	TUBO FLESSIB ACC INOX M10X1 F1/2 35CM BLIST	PLAC+GUARN		4,78 €
BL11000135	TUBO FLESSIB ACC INOX M10X1 F3/8 35CM BLIST	PLAC+GUARN		4,78 €
BL11000090	TUBO FLESSIBILE ACC INOX F1/2 F1/2 25CM BLIST	PLAC+GUARN		4,50 €
BL11000095	TUBO FLESSIBILE ACC INOX F1/2 F1/2 30CM BLIST	PLAC+GUARN		4,62 €

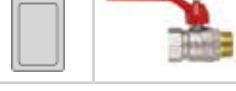
CODICE	DESCRIZIONE	PACKAGING	IMMAGINE	LISTINO
BL11000100	TUBO FLESSIBILE ACC INOX F1/2 F1/2 35CM BLIST	PLAC+GUARN	 	4,78 €
BL11000105	TUBO FLESSIBILE ACC INOX F1/2 F1/2 40CM BLIST	PLAC+GUARN	 	4,93 €
BL11000110	TUBO FLESSIBILE ACC INOX F1/2 F3/8 25CM BLIST	PLAC+GUARN	 	4,50 €
BL11000115	TUBO FLESSIBILE ACC INOX F1/2 F3/8 30CM BLIST	PLAC+GUARN	 	4,62 €
BL11000120	TUBO FLESSIBILE ACC INOX F1/2 F3/8 35CM BLIST	PLAC+GUARN	 	4,78 €
BL11000125	TUBO FLESSIBILE ACC INOX F1/2 F3/8 40CM BLIST	PLAC+GUARN	 	4,93 €
BL12200185	TUBO FLESSIBILE ACC INOX F3/8 F3/8 30CM BLIST	PLAC+GUARN	 	4,62 €
BL12200190	TUBO FLESSIBILE ACC INOX F3/8 F3/8 40CM BLIST	PLAC+GUARN	 	4,93 €
BL11000005	TUBO FLESSIBILE ACC INOX M1/2 F1/2 25CM BLIST	PLAC+GUARN	 	4,50 €
BL11000010	TUBO FLESSIBILE ACC INOX M1/2 F1/2 30CM BLIST	PLAC+GUARN	 	4,62 €
BL11000015	TUBO FLESSIBILE ACC INOX M1/2 F1/2 35CM BLIST	PLAC+GUARN	 	4,78 €
BL11000020	TUBO FLESSIBILE ACC INOX M1/2 F1/2 40CM BLIST	PLAC+GUARN	 	4,93 €
BL11000025	TUBO FLESSIBILE ACC INOX M1/2 F1/2 50CM BLIST	PLAC+GUARN	 	5,18 €
BL11000070	TUBO FLESSIBILE ACC INOX M1/2 F3/8 25CM BLIST	PLAC+GUARN	 	4,50 €
BL11000075	TUBO FLESSIBILE ACC INOX M1/2 F3/8 30CM BLIST	PLAC+GUARN	 	4,62 €

CODICE	DESCRIZIONE	PACKAGING	IMMAGINE	LISTINO
BL1100080	TUBO FLESSIBILE ACC INOX M1/2 F3/8 35CM BLIST	PLAC+GUARN		4,78 €
BL1100085	TUBO FLESSIBILE ACC INOX M1/2 F3/8 40CM BLIST	PLAC+GUARN		4,93 €
BL1100030	TUBO FLESSIBILE ACC INOX M3/8 F1/2 25CM BLIST	PLAC+GUARN		4,50 €
BL1100035	TUBO FLESSIBILE ACC INOX M3/8 F1/2 30CM BLIST	PLAC+GUARN		4,62 €
BL1100040	TUBO FLESSIBILE ACC INOX M3/8 F1/2 35CM BLIST	PLAC+GUARN		4,78 €
BL1100045	TUBO FLESSIBILE ACC INOX M3/8 F1/2 40CM BLIST	PLAC+GUARN		4,93 €
BL1100050	TUBO FLESSIBILE ACC INOX M3/8 F3/8 25CM BLIST	PLAC+GUARN		4,50 €
BL1100055	TUBO FLESSIBILE ACC INOX M3/8 F3/8 30CM BLIST	PLAC+GUARN		4,62 €
BL1100060	TUBO FLESSIBILE ACC INOX M3/8 F3/8 35CM BLIST	PLAC+GUARN		4,78 €
BL1100065	TUBO FLESSIBILE ACC INOX M3/8 F3/8 40CM BLIST	PLAC+GUARN		4,93 €
BL1180035	TUBO SCARICO LAV. C/MANICOT E CURVA 150CM BLI	CART GRANDE		3,10 €
BL1180040	TUBO SCARICO LAV. C/MANICOT E CURVA 200CM BLI	CART GRANDE		3,60 €
BL1180045	TUBO SCARICO LAV. C/MANICOT E CURVA 250CM BLI	CART GRANDE		4,09 €
BL1180047	TUBO SCARICO LAVATR ESTENS 90/300CM D.21 BLIS	CART GRANDE		4,12 €
BL1780015	VALVOLA A SFERA 1/2" F+F BLISTER	BL8		6,77 €

CODICE	DESCRIZIONE	PACKAGING	IMMAGINE	LISTINO
BL17800270	VALVOLA A SFERA 1/2" F+F ROSSA FARFALLA BL	BL8		6,37 €
BL17800020	VALVOLA A SFERA 1/2" M+F BLISTER	BL7		7,16 €
BL17800280	VALVOLA A SFERA 1/2" M+F ROSSA FARFALLA BL	BL8		6,74 €
BL17800038	VALVOLA A SFERA 3/4" F+F BLISTER	BL8		8,79 €
BL17800275	VALVOLA A SFERA 3/4" F+F ROSSA FARFALLA BL	BL8		8,21 €
BL17800040	VALVOLA A SFERA 3/4" M+F BLISTER	BL7		9,19 €
BL17800285	VALVOLA A SFERA 3/4" M+F ROSSA FARFALLA BL	BL8		8,64 €
BL17800014	VALVOLA A SFERA 3/8" F+F BLISTER	BL8		6,62 €
BL15800035	VALVOLA SFOGO ARIA OTT PES SBIANCATO 1/4 BLIS	BL1		3,01 €
BL15800040	VOLANTINO UNIVERSALE X VALVOLE RADIATORI BLIS	BL5		2,74 €

CODIFICA BLISTER

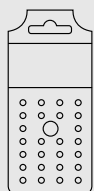

PLAC+GUARN

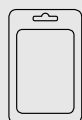

BL1/2/3/4/5

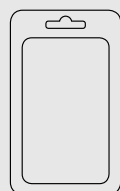

BL6/7/8/9/11

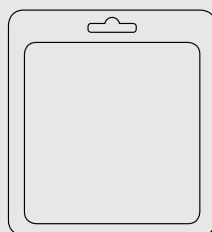

BL10

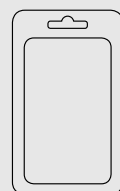

BL12

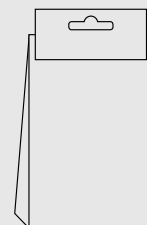

CART PICC

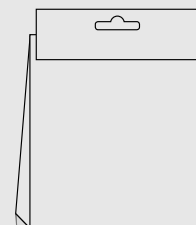

CART GRANDE

PLACCHETTA
IN PLASTICA

BLISTER
PICCOLO

BLISTER
MEDIO

BLISTER
GRANDE

SKIN
PACK

SACCHETTO
PICCOLO

SACCHETTO
GRANDE